

TOSHIBA Photointerrupter Infrared LED + Photo-IC

TLP1255 (C8,Q)

Copiers, Printers and Fax Machines

Air Conditioners

Game Machines

The TLP1255 (C8,Q) is a compact photointerrupter with a built-in connector, which uses a GaAs infrared LED and a Si photo-IC. Designed for 3.3/5 V systems, the device can operate at temperatures of up to 95°C. When the light is shielded, outputs are at high level.

Small package

Compared to Toshiba's TLP1253 (C6,Q) , the volume and the mounting area of the TLP1255 (C8,Q) are reduced to 70% and 75% respectively.

Three board thicknesses supported: 1.0 mm, 1.2 mm and 1.6 mm

Gap: 5 mm

Resolution: Slit width = 0.7 mm

Designed for 3.3 /5 V system

High-temperature operation: $T_{opr} = 95^{\circ}\text{C}$ (max)

Low current consumption: $I_{CC} = 14$ mA (max)

Digital output (open collector)

Mini CT connector (1.5 mm pitch MT RECEPTACLE ASSEMBLY / HOUSING CRIMP TYPE) made by Tyco Electronics AMP, Ltd.

Package and connector material: Polycarbonate (UL94V-2)

Lead(Pb)-Free Finish

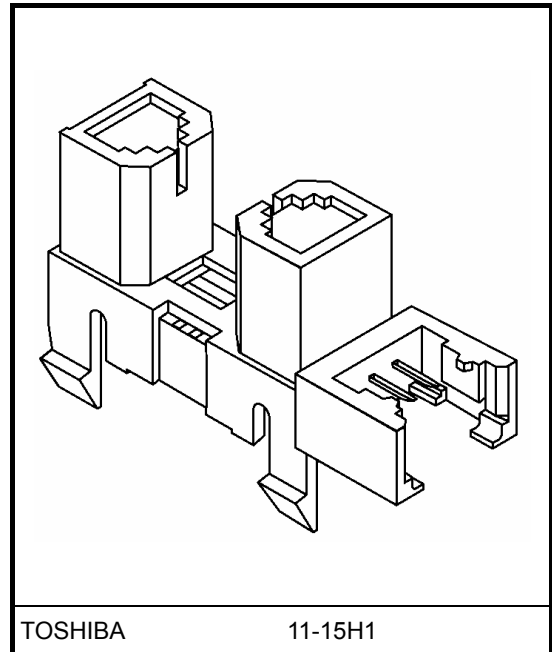

Weight: 0.8 g (typ.)

Marking

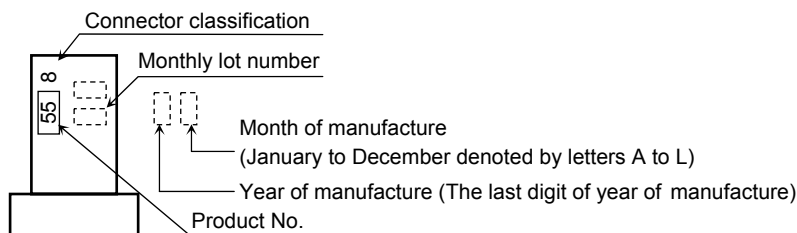

Absolute Maximum Ratings (Ta = 25°C)

Characteristic	Symbol	Rating	Unit
Supply voltage	V _{CC}	7.5	V
Output voltage	V _O	15	V
Low level output current (T _a = T _{opr})	I _{OL}	16	mA
Operating temperature range	T _{opr}	-30 to 95	°C
Storage temperature range	T _{stg}	-40 to 100	°C

Note: Using continuously under heavy loads (e.g. the application of high temperature/current/voltage and the significant change in temperature, etc.) may cause this product to decrease in the reliability significantly even if the operating conditions (i.e. operating temperature/current/voltage, etc.) are within the absolute maximum ratings and the operating ranges.

Please design the appropriate reliability upon reviewing the Toshiba Semiconductor Reliability Handbook ("Handling Precautions"/"Derating Concept and Methods") and individual reliability data (i.e. reliability test report and estimated failure rate, etc).

Operating Ranges

Characteristic	Symbol	Min	Typ.	Max	Unit
Supply voltage	V _{CC}	2.97	—	5.5	V
Output voltage	V _O	—	—	13.2	V
Low level output current	I _{OL}	—	—	16	mA

Optical and Electrical Characteristics

(Unless Otherwise Specified, Ta = -30~95°C, V_{CC} = 2.97 V ~ 5.5 V)

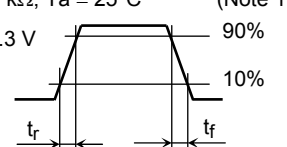
Characteristic	Symbol	Test conditions	Min	Typ.	Max	Unit	
Supply voltage	V _{CC}		2.97	—	5.5	V	
Supply current	High level	I _{CCH}	When light is shielded	—	—	14	mA
	Low level	I _{CCL}	When light is detected	—	—	14	mA
Output voltage	High level	V _{OH}	When light is shielded, R _L = 47 kΩ	0.9 V _{CC}	—	—	V
	Low level	V _{OL}	When light is detected, I _{OL} = 16 mA, Ta = 25°C	—	0.09	0.35	V
			When light is detected, I _{OL} = 16 mA	—	—	0.4	V
Peak emission wavelength	λ _P	Ta = 25°C, LED	—	940	—	nm	
Peak sensitivity wavelength	λ _P	Ta = 25°C, Photo-IC	—	900	—	nm	
Response frequency	f	R _L = 4.7 kΩ, Ta = 25°C (Note 1) V _{CC} = 3.3 V	5	—	—	kHz	
Rise time	t _r		—	0.5	—	μs	
Fall time	t _f		—	0.02	—		

Note 1: The measurement of the response frequency is the value obtained when the shutter has been rotated as shown below. The output must not be DC.

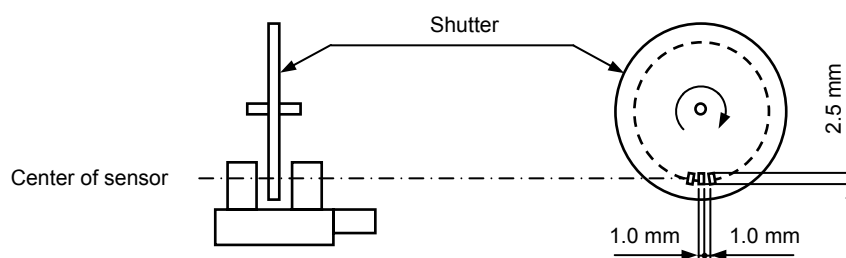

Recommended Connector

Mini CT connector (1.5 mm pitch, receptacle assembly / housing crimp type) made by Tyco Electronics AMP, Ltd.

Housing-Terminal En Bloc Type	Type	Model Number	Terminal Material	AWG Size	External Diameter of Insulation Coating
	Receptacle assembly	353293-3	Phosphor bronze	AWG26 to 28	0.85 mm to 0.95 mm
	Housing crimp	353908-3			

Note 2: For further details of connector characteristics, please contact the relevant connector manufacturer.

Precautions

At power-on the internal circuit takes about 100 μs to stabilize. During this period any output signal would be unstable and liable to change. Design the circuit so that no signal is output during this period.

The device when installed should be protected from interference by ambient light. The integrated phototransistor is insensitive to light of 700 nm or less (e.g., fluorescent light), but is sensitive to light above 700 nm (e.g., incandescent light). Detecting ambient light may cause the device to trigger a malfunction. Test and evaluate thoroughly any end-equipment in which the device is used to ensure that no such interference will occur.

Take due care regarding the environment in which the device is to be installed. Oil or chemicals may cause the package to melt or crack.

When attaching the device to the metal board, always hold the body of the device. Do not hold it by the connector.

Ensure that the board is flat, and not warped or twisted. Attach the device to a metal board at room temperature.

Toshiba recommends attaching the device to the smoother side of the board.

Toshiba recommends testing the attachment strength beforehand by actually attaching a device to the board.

Do not apply solder to the pins of the device connector. Make sure that the connector is linked to the Mini CT connector or equivalent connector.

When inserting or removing the Mini CT connector or equivalent connector, always grasp the connector and its cable firmly and either plug the connector into or pull it out of the device connector straight and not at an angle. Inserting or removing the Mini CT connector or equivalent connector at an angle may cause damage to both the connector of the device and the Mini CT connector or equivalent connector, resulting in an unreliable connection.

The leadframe of the package and the resistance are exposed, as shown below. Design the housing and chassis of end-equipment with particular care to ensure that no conductive material or object (such as a metal pin) drops on the leads of the leadframe or on both ends of the resistance terminal to cause a short circuit between them.

Top view

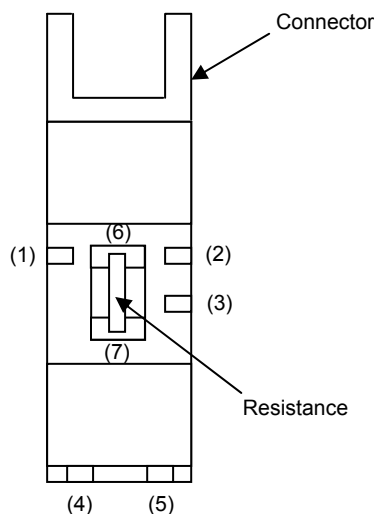

Leads (1) to (5) of the leadframe and (6) to (7) of the resistance terminal shown on the left must not be shorted together

Package Dimensions:

TOSHIBA 11-15H1

Unit: mm

() : Reference value
Tolerances are listed below unless otherwise specified.

Dimensions	Tolerance
6 mm or less	±0.1
Greater than 6 mm	±0.2

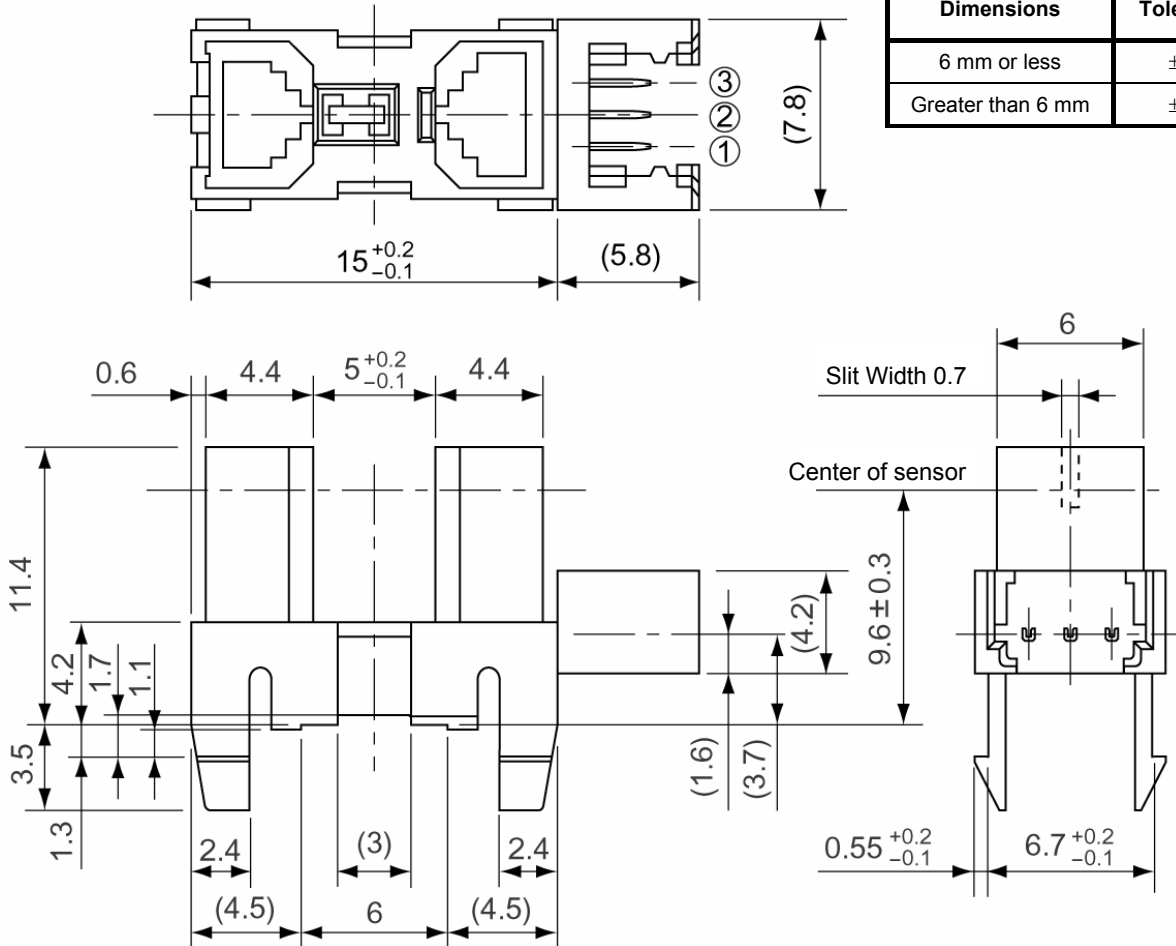

Weight: 0.8 g (typ.)

Pin Connection

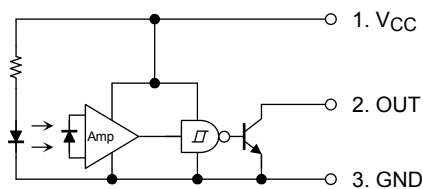

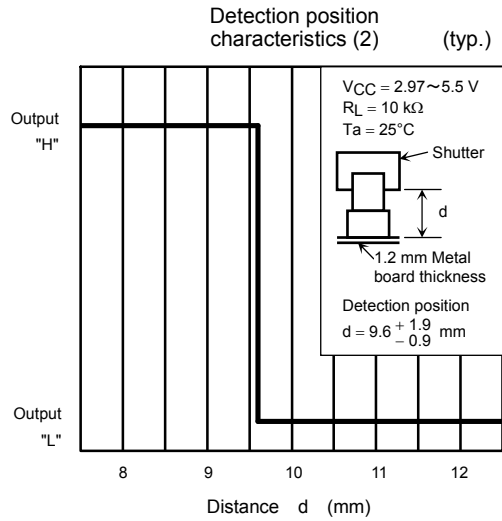
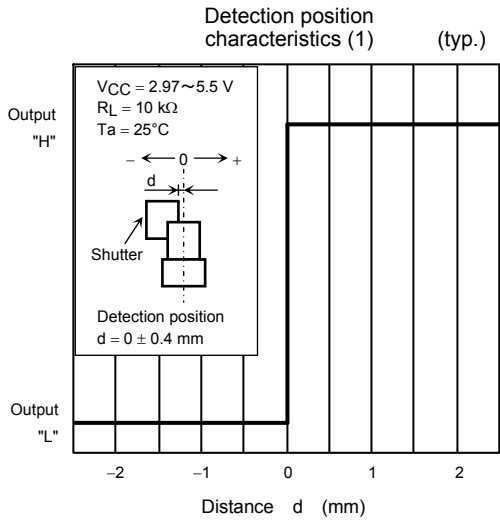
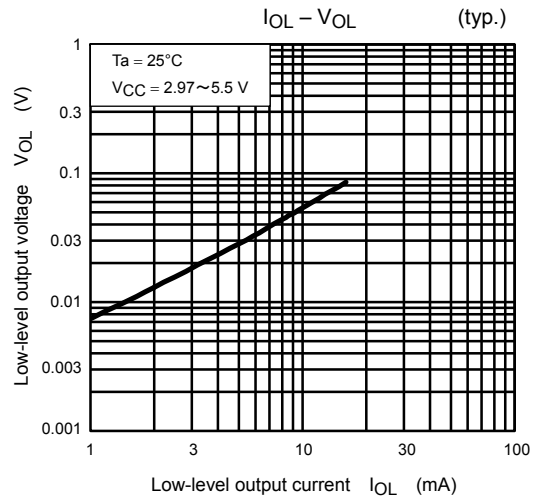

Relative Positioning of Shutter and Device

For normal operation, position the shutter and the device as shown in the figure below. Take into account the device's detection direction characteristic and switching time in determining the shutter slit width and pitch.

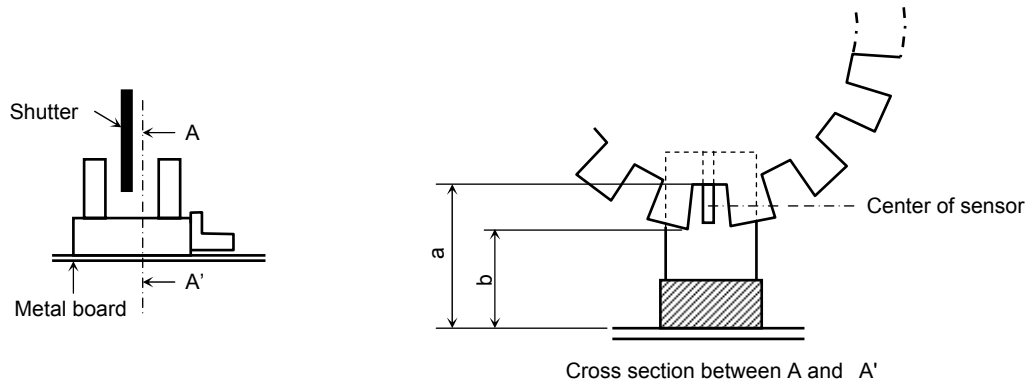

Unit: mm

Thickness of Metal Board	a Dimension	b Dimension
1.0	11.7 min	8.9 max
1.2	11.5 min	8.7 max
1.6	11.1 min	8.3 max

Recommended Size of Connection Holes (Unit: mm)

1.0 mm thick metal board

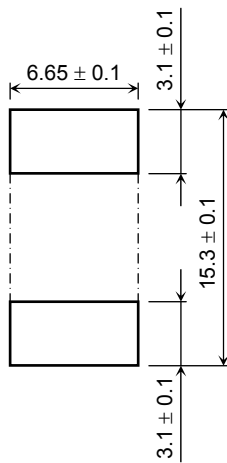

1.2 mm thick metal board

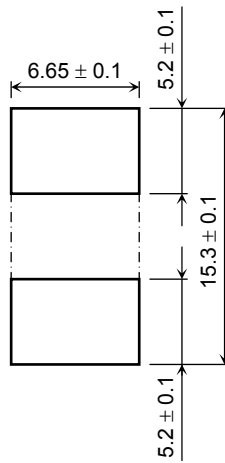

1.6 mm thick metal board

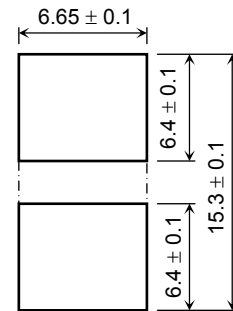

RESTRICTIONS ON PRODUCT USE

20070701-EN

- The information contained herein is subject to change without notice.
- TOSHIBA is continually working to improve the quality and reliability of its products. Nevertheless, semiconductor devices in general can malfunction or fail due to their inherent electrical sensitivity and vulnerability to physical stress. It is the responsibility of the buyer, when utilizing TOSHIBA products, to comply with the standards of safety in making a safe design for the entire system, and to avoid situations in which a malfunction or failure of such TOSHIBA products could cause loss of human life, bodily injury or damage to property.
In developing your designs, please ensure that TOSHIBA products are used within specified operating ranges as set forth in the most recent TOSHIBA products specifications. Also, please keep in mind the precautions and conditions set forth in the "Handling Guide for Semiconductor Devices," or "TOSHIBA Semiconductor Reliability Handbook" etc.
- The TOSHIBA products listed in this document are intended for usage in general electronics applications (computer, personal equipment, office equipment, measuring equipment, industrial robotics, domestic appliances, etc.). These TOSHIBA products are neither intended nor warranted for usage in equipment that requires extraordinarily high quality and/or reliability or a malfunction or failure of which may cause loss of human life or bodily injury ("Unintended Usage"). Unintended Usage include atomic energy control instruments, airplane or spaceship instruments, transportation instruments, traffic signal instruments, combustion control instruments, medical instruments, all types of safety devices, etc.. Unintended Usage of TOSHIBA products listed in this document shall be made at the customer's own risk.
- The products described in this document shall not be used or embedded to any downstream products of which manufacture, use and/or sale are prohibited under any applicable laws and regulations.
- The information contained herein is presented only as a guide for the applications of our products. No responsibility is assumed by TOSHIBA for any infringements of patents or other rights of the third parties which may result from its use. No license is granted by implication or otherwise under any patents or other rights of TOSHIBA or the third parties.
- GaAs(Gallium Arsenide) is used in this product. The dust or vapor is harmful to the human body. Do not break, cut, crush or dissolve chemically.
- Please contact your sales representative for product-by-product details in this document regarding RoHS compatibility. Please use these products in this document in compliance with all applicable laws and regulations that regulate the inclusion or use of controlled substances. Toshiba assumes no liability for damage or losses occurring as a result of noncompliance with applicable laws and regulations.