

TOSHIBA CMOS DIGITAL INTEGRATED CIRCUIT SILICON MONOLITHIC

TC7WH74FU, TC7WH74FK

D-TYPE FLIP FLOP WITH PRESET AND CLEAR

The TC7WH74 is an advanced high speed CMOS D-FLIP FLOP fabricated with silicon gate CMOS technology. It achieves the high speed operation similar to equivalent Bipolar Schottky TTL while maintaining the CMOS low power dissipation.

The signal level applied to the D INPUT is transferred to Q OUTPUT during the positive going transition of the CK pulse.

CLR and PR are independent of the CK and are accomplished by setting the appropriate input low.

An input protection circuit ensures that 0 to 7V can be applied to the input pins without regard to the supply voltage. This device can be used to interface 5V to 3V system and two supply systems such as battery back up. This circuit prevents device destruction due to mismatched supply and input voltages.

FEATURES

- High Speed $f_{MAX} = 170\text{MHz (Typ.)}$ at $V_{CC} = 5\text{V}$
- Low Power Dissipation $I_{CC} = 2\mu\text{A (Max.)}$ at $T_a = 25^\circ\text{C}$
- High Noise Immunity $V_{NIH} = V_{NIL} = 28\% V_{CC}$ (Min.)
- Power Down Protection is provided on all inputs.
- Balanced Propagation Delays $t_{pLH} \approx t_{pHL}$
- Wide Operation Voltage Range ... $V_{CC} (\text{opr}) = 2 \sim 5.5\text{V}$

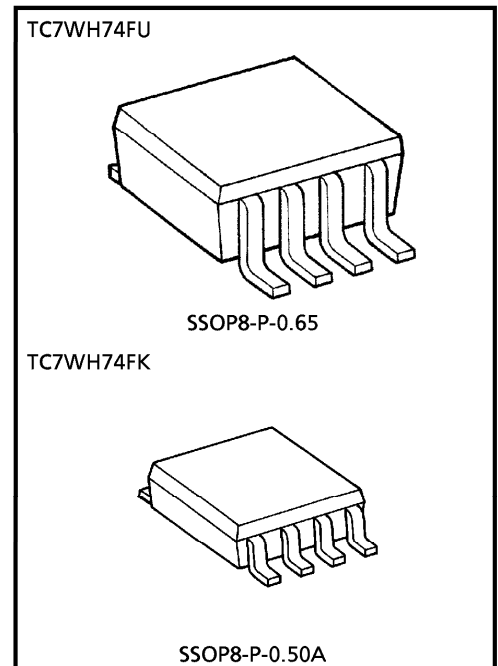

Weight
 SSOP8-P-0.65 : 0.02g (Typ.)
 SSOP8-P-0.50A : 0.01g (Typ.)

MARKING

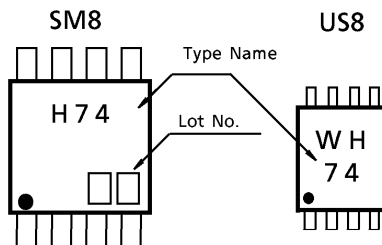

PIN ASSIGNMENT (TOP VIEW)

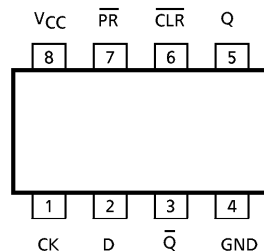

MAXIMUM RATINGS (Ta = 25°C)

CHARACTERISTIC	SYMBOL	RATING	UNIT
Supply Voltage Range	V _{CC}	-0.5~7.0	V
DC Input Voltage	V _{IN}	-0.5~7.0	V
DC Output Voltage	V _{OUT}	-0.5~V _{CC} +0.5	V
Input Diode Current	I _{IK}	-20	mA
Output Diode Current	I _{OK}	±20	mA
DC Output Current	I _{OUT}	±25	mA
DC V _{CC} /Ground Current	I _{CC}	±50	mA
Power Dissipation	P _D	300 (SM8)	mW
		200 (US8)	
Storage Temperature	T _{stg}	-65~150	°C
Lead Temperature (10 s)	T _L	260	°C

LOGIC DIAGRAM

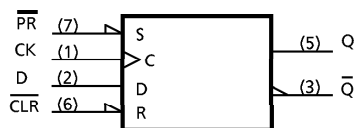

TRUTH TABLE

INPUTS				OUTPUTS		FUNCTION
CLR	PR	D	CK	Q	Q̄	
L	H	x	x	L	H	CLEAR
H	L	x	x	H	L	PRESET
L	L	x	x	H	H	—
H	H	L	↑	L	H	—
H	H	H	↑	H	L	—
H	H	x	↓	Q _n	Q̄ _n	NO CHANGE

x : Don't care

RECOMMENDED OPERATING CONDITIONS

CHARACTERISTIC	SYMBOL	RATING	UNIT
Supply Voltage	V _{CC}	2~5.5	V
Input Voltage	V _{IN}	0~V _{CC}	V
Output Voltage	V _{OUT}	0~V _{CC}	V
Operating Temperature	T _{opr}	-40~85	°C
Input Rise and Fall Time	dt/dv	0~100 (V _{CC} = 3.3 ± 0.3V)	ns/V
		0~20 (V _{CC} = 5 ± 0.5V)	

DC ELECTRICAL CHARACTERISTICS

CHARACTERISTIC	SYMBOL	TEST CONDITION	V _{CC} (V)	Ta = 25°C			Ta = -40~85°C		UNIT	
				MIN.	TYP.	MAX.	MIN.	MAX.		
High-Level Input Voltage	V _{IH}	—	2.0	1.5	—	—	1.5	—	V	
			3.0~5.5	V _{CC} × 0.7	—	—	V _{CC} × 0.7	—		
Low-Level Input Voltage	V _{IL}	—	2.0	—	—	0.5	—	0.5	V	
			3.0~5.5	—	—	V _{CC} × 0.3	—	V _{CC} × 0.3		
High-Level Output Voltage	V _{OH}	V _{IN} = V _{IH} or V _{IL}	I _{OH} = -50 μA	2.0	1.9	2.0	—	1.9	—	V
				3.0	2.9	3.0	—	2.9	—	
			I _{OH} = -4mA	4.5	4.4	4.5	—	4.4	—	
				4.5	3.94	—	—	3.80	—	
Low-Level Output Voltage	V _{OL}	V _{IN} = V _{IH} or V _{IL}	I _{OL} = 50 μA	2.0	—	0.0	0.1	—	0.1	V
				3.0	—	0.0	0.1	—	0.1	
				4.5	—	0.0	0.1	—	0.1	
			I _{OL} = 4mA	3.0	—	—	0.36	—	0.44	
				4.5	—	—	0.36	—	0.44	
Input Leakage Current	I _{IN}	V _{IN} = V _{CC} or GND	0~5.5	—	—	±0.1	—	±1.0	μA	
Quiescent Supply Current	I _{CC}	V _{IN} = V _{CC} or GND	5.5	—	—	2.0	—	20.0	μA	

TIMING REQUIREMENTS (Input t_r = t_f = 3ns)

CHARACTERISTIC	SYMBOL	TEST CONDITION	V _{CC} (V)	Ta = 25°C		Ta = -40~85°C	UNIT
				TYP.	LIMIT	LIMIT	
Minimum Pulse Width (CLOCK)	t _W (L)		3.3 ± 0.3	—	6.0	7.0	ns
	t _W (H)		5.0 ± 0.5	—	5.0	5.0	
Minimum Pulse Width (CLR, PR)	t _W (L)		3.3 ± 0.3	—	6.0	7.0	ns
			5.0 ± 0.5	—	5.0	5.0	
Minimum Set-up Time	t _s		3.3 ± 0.3	—	7.0	7.0	ns
			5.0 ± 0.5	—	5.0	5.0	
Minimum Hold Time	t _h		3.3 ± 0.3	—	0.5	0.5	ns
			5.0 ± 0.5	—	0.5	0.5	
Minimum Removal Time (CLR, PR)	t _{rem}		3.3 ± 0.3	—	5.0	5.0	ns
			5.0 ± 0.5	—	3.0	3.0	

AC ELECTRICAL CHARACTERISTICS (Input $t_r = t_f = 3ns$)

CHARACTERISTIC	SYMBOL	TEST CONDITION		Ta = 25°C			Ta = -40~85°C		UNIT
		V _{CC} (V)	C _L (pF)	MIN.	TYP.	MAX.	MIN.	MAX.	
Propagation Delay Time (CK-Q, \bar{Q})	t _{pLH}	3.3 ± 0.3	15	—	6.7	11.9	1.0	14.0	ns
			50	—	9.2	15.4	1.0	17.5	
	5.0 ± 0.5	15	—	4.6	7.3	1.0	8.5		
		50	—	6.1	9.3	1.0	10.5		
Propagation Delay Time (\bar{CLR} , $\bar{PR-Q}$, \bar{Q})	t _{pLH}	3.3 ± 0.3	15	—	7.6	12.3	1.0	14.5	ns
			50	—	10.1	15.8	1.0	18.0	
	5.0 ± 0.5	15	—	4.8	7.7	1.0	9.0		
		50	—	6.3	9.7	1.0	11.0		
Maximum Clock Frequency	f _{MAX}	3.3 ± 0.3	15	80	125	—	70	—	MHz
			50	50	75	—	45	—	
		5.0 ± 0.5	15	130	170	—	110	—	
			50	90	115	—	75	—	
Input Capacitance	C _{IN}			—	4	10	—	10	pF
Power Dissipation Capacitance	C _{PD}	(Note 1)		—	22	—	—	—	pF

(Note 1) : C_{PD} is defined as the value of the internal equivalent capacitance which is calculated from the operating current consumption without load.

Average operating current can be obtained by the equation :

$$I_{CC (opr)} = C_{PD} \cdot V_{CC} \cdot f_{IN} + I_{CC}$$

INPUT EQUIVALENT CIRCUIT

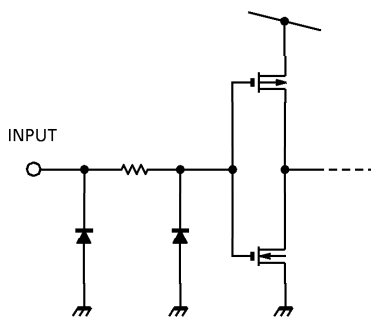

PACKAGE DIMENSIONS
SSOP8-P-0.65

Unit : mm

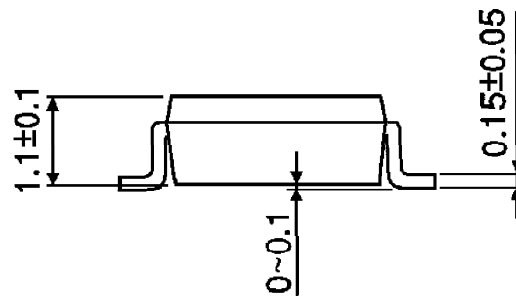
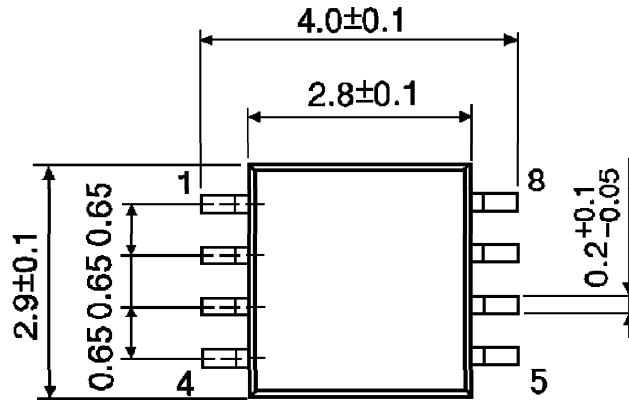

Weight : 0.02g (Typ.)

PACKAGE DIMENSIONS
SSOP8-P-0.50A

Unit : mm

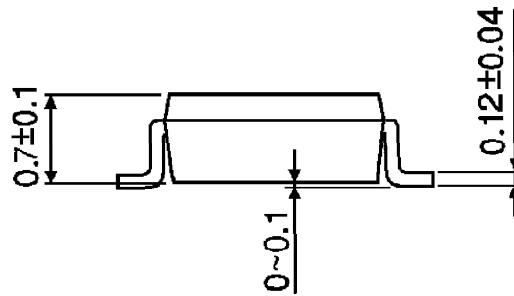
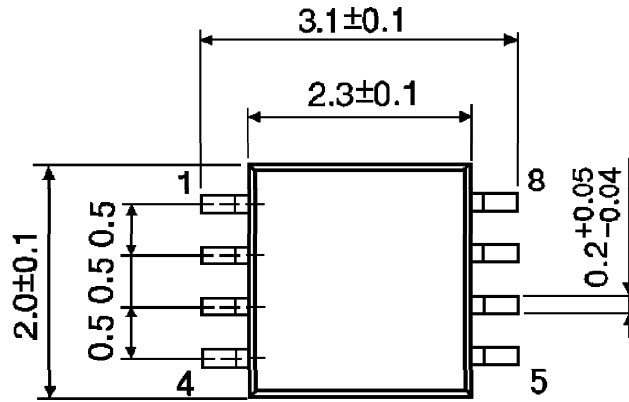

Weight : 0.01g (Typ.)

RESTRICTIONS ON PRODUCT USE

000707EBA

- TOSHIBA is continually working to improve the quality and reliability of its products. Nevertheless, semiconductor devices in general can malfunction or fail due to their inherent electrical sensitivity and vulnerability to physical stress. It is the responsibility of the buyer, when utilizing TOSHIBA products, to comply with the standards of safety in making a safe design for the entire system, and to avoid situations in which a malfunction or failure of such TOSHIBA products could cause loss of human life, bodily injury or damage to property. In developing your designs, please ensure that TOSHIBA products are used within specified operating ranges as set forth in the most recent TOSHIBA products specifications. Also, please keep in mind the precautions and conditions set forth in the "Handling Guide for Semiconductor Devices," or "TOSHIBA Semiconductor Reliability Handbook" etc..
- The TOSHIBA products listed in this document are intended for usage in general electronics applications (computer, personal equipment, office equipment, measuring equipment, industrial robotics, domestic appliances, etc.). These TOSHIBA products are neither intended nor warranted for usage in equipment that requires extraordinarily high quality and/or reliability or a malfunction or failure of which may cause loss of human life or bodily injury ("Unintended Usage"). Unintended Usage include atomic energy control instruments, airplane or spaceship instruments, transportation instruments, traffic signal instruments, combustion control instruments, medical instruments, all types of safety devices, etc.. Unintended Usage of TOSHIBA products listed in this document shall be made at the customer's own risk.
- The products described in this document are subject to the foreign exchange and foreign trade laws.
- The information contained herein is presented only as a guide for the applications of our products. No responsibility is assumed by TOSHIBA CORPORATION for any infringements of intellectual property or other rights of the third parties which may result from its use. No license is granted by implication or otherwise under any intellectual property or other rights of TOSHIBA CORPORATION or others.
- The information contained herein is subject to change without notice.