

CMC01

For Strobe Discharge Circuit

- Repetitive peak reverse voltage
 - : VRRM = 400 V
 - Average forward current: $I_{F(AV)} = 1.0$ A
 - Repetitive peak forward current: $I_{FRM} = 150$ A (Refer to the Note 2)
- Small surface-mount package
 "M-FLAT™" (Toshiba package name)

Absolute Maximum Ratings (Ta = 25°C)

Characteristics	Symbol	Rating	Unit
Repetitive peak reverse voltage	VRRM	400	V
Average forward current (Note 1)	$I_{F(AV)}$	1.0(Ta=47°C)	A
Peak one cycle surge forward current (non-repetitive)	I_{FSM}	30 (50 Hz)	A
Repetitive peak forward current (Note 2)	I_{FRM}	150	A
Junction temperature	Tj	-40~150	°C
Storage temperature range	Tstg	-40~150	°C

Note 1: Device mounted on a glass-epoxy board
 board size: 50 mm × 50 mm
 soldering land: 6 mm × 6 mm
 glass-epoxy board thickness 1.6t

Note 3: Using continuously under heavy loads (e.g. the application of high temperature/current/voltage and the significant change in temperature, etc.) may cause this product to decrease in the reliability significantly even if the operating conditions (i.e. operating temperature/current/voltage, etc.) are within the absolute maximum ratings. Please design the appropriate reliability upon reviewing the Toshiba Semiconductor Reliability Handbook ("Handling Precautions"/Derating Concept and Methods) and individual reliability data (i.e. reliability test report and estimated failure rate, etc).

Electrical Characteristics (Ta = 25°C)

Characteristics	Symbol	Test Condition	Min	Typ.	Max	Unit
Peak forward voltage	VFM	$I_{FM} = 1.0$ A (Pulse test)	—	0.86	1.0	V
Repetitive peak reverse current	IRRM	VRRM = 400 V (Pulse test)	—	—	10	μA
Thermal resistance	Rth(j-a)	Device mounted on a ceramic board Board size: 50 mm × 50 mm Soldering land: 2 mm × 2 mm Ceramic board thickness: 0.64t	—	—	60	°C/W
		Device mounted on a glass-epoxy board Board size: 50 mm × 50 mm Soldering land: 6 mm × 6 mm glass-epoxy board thickness: 1.6t	—	—	110	
		Device mounted on a glass-epoxy board Board size: 50 mm × 50 mm Soldering land: 2.1 mm × 1.4 mm glass-epoxy board thickness: 1.6t	—	—	180	
	Rth(j-ℓ)	—	—	16	°C/W	

Unit: mm

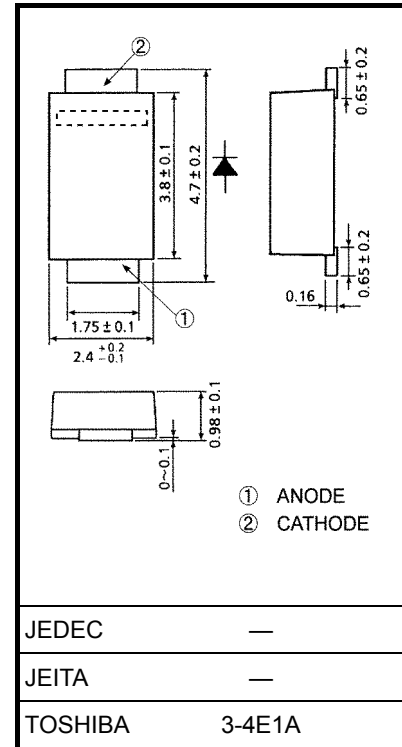

Weight: 0.023 g (typ.)

Note 2 Repetitive peak forward current waveform

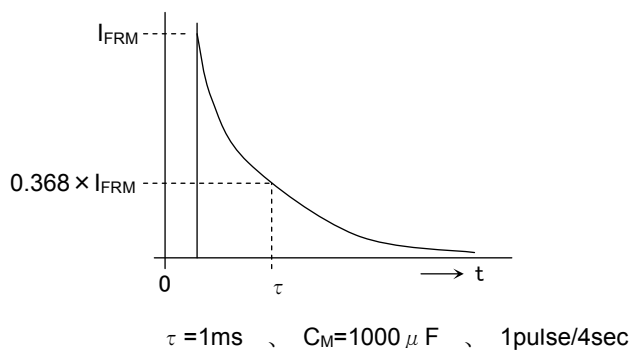

Marking

Abbreviation Code	Part No.
C1	CMC01

Standard Soldering Pad

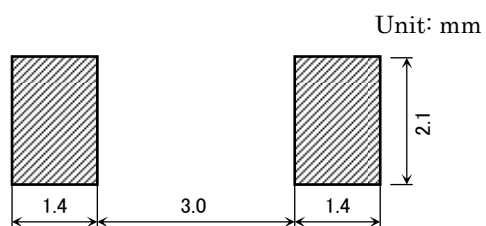

Handling Precaution

The absolute maximum ratings denote the absolute maximum ratings, which are rated values and must not be exceeded during operation, even for an instant. The following are the general derating methods that we recommend when you design a circuit with a device.

V_{RRM} : We recommend that the worst case voltage, including surge voltage, be no greater than 80% of the absolute maximum rating of V_{RRM} for a DC circuit and be no greater than 50% of that of V_{RRM} for an AC circuit.

V_{RRM} has a temperature coefficient of 0.1%/°C. Take this temperature coefficient into account designing a device at low temperature.

$I_{F(AV)}$: We recommend that the worst case current be no greater than 80% of the absolute maximum rating of $I_{F(AV)}$.

Carry out adequate heat design. If you can't design a circuit with excellent heat radiation, please set the margin by using an allowable $T_{max}-I_{F(AV)}$ curve.

This rating is only applied for a strobe flash circuit. We recommend that the worst case current be controlled less than the absolute maximum rating of I_{FRM} . The total number of repetitive currents must be less than 5000 times within the lifespan of the device.

This rating specifies the non-repetitive peak current in one cycle of a 50-Hz sine wave, condition angle 180. Therefore, this is only applied for an abnormal operation, which seldom occurs during the lifespan of the device.

We recommend that a device be used at a T_j of below 120°C under the worst load and heat radiation conditions.

Thermal resistance between junction and ambient fluctuates depending on the device's mounting condition. When using a device, design a circuit board and a soldering land size to match the appropriate thermal resistance value.

Please refer to the Rectifiers databook for further information.

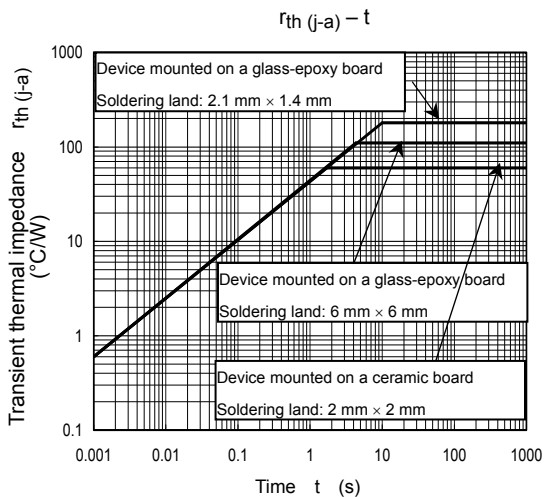
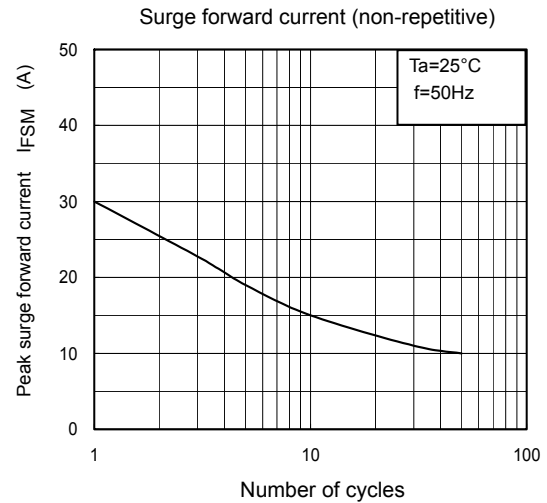
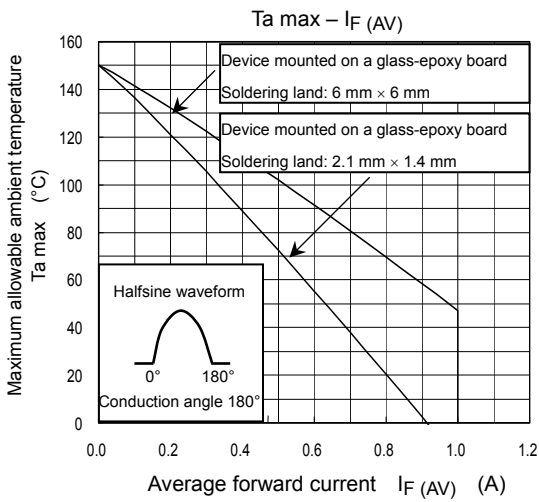
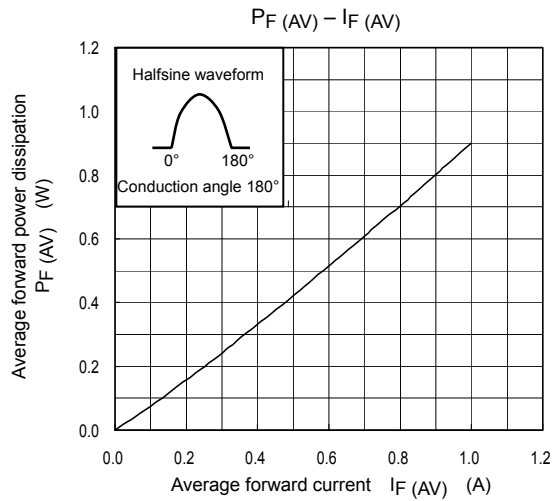
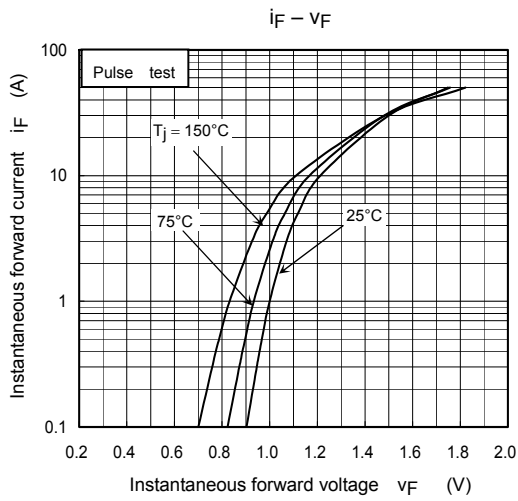

RESTRICTIONS ON PRODUCT USE

20070701-EN

- The information contained herein is subject to change without notice.
- TOSHIBA is continually working to improve the quality and reliability of its products. Nevertheless, semiconductor devices in general can malfunction or fail due to their inherent electrical sensitivity and vulnerability to physical stress. It is the responsibility of the buyer, when utilizing TOSHIBA products, to comply with the standards of safety in making a safe design for the entire system, and to avoid situations in which a malfunction or failure of such TOSHIBA products could cause loss of human life, bodily injury or damage to property.
In developing your designs, please ensure that TOSHIBA products are used within specified operating ranges as set forth in the most recent TOSHIBA products specifications. Also, please keep in mind the precautions and conditions set forth in the "Handling Guide for Semiconductor Devices," or "TOSHIBA Semiconductor Reliability Handbook" etc.
- The TOSHIBA products listed in this document are intended for usage in general electronics applications (computer, personal equipment, office equipment, measuring equipment, industrial robotics, domestic appliances, etc.). These TOSHIBA products are neither intended nor warranted for usage in equipment that requires extraordinarily high quality and/or reliability or a malfunction or failure of which may cause loss of human life or bodily injury ("Unintended Usage"). Unintended Usage include atomic energy control instruments, airplane or spaceship instruments, transportation instruments, traffic signal instruments, combustion control instruments, medical instruments, all types of safety devices, etc.. Unintended Usage of TOSHIBA products listed in this document shall be made at the customer's own risk.
- The products described in this document shall not be used or embedded to any downstream products of which manufacture, use and/or sale are prohibited under any applicable laws and regulations.
- The information contained herein is presented only as a guide for the applications of our products. No responsibility is assumed by TOSHIBA for any infringements of patents or other rights of the third parties which may result from its use. No license is granted by implication or otherwise under any patents or other rights of TOSHIBA or the third parties.
- Please contact your sales representative for product-by-product details in this document regarding RoHS compatibility. Please use these products in this document in compliance with all applicable laws and regulations that regulate the inclusion or use of controlled substances. Toshiba assumes no liability for damage or losses occurring as a result of noncompliance with applicable laws and regulations.