

Surface Mount 90° Hybrid
3650 – 4050 MHz

MA4HYB390-1303T
V1

Features

- Monolithic Construction
- 400 MHz B.W.
- Excellent Phase Balance (< +/- 3 deg)
- Decent Amplitude Balance (< +/- 1.4 dB)
- Output Port to Port Isolation > 20 dB
- 2mm Low Cost MLP Plastic Package
- RoHS Compliant

Description and Applications

M/A-COM's MA4HYB390-1303T is a 50 Ω Characteristic Impedance, Monolithic Passive Integrated Circuit designed to provide a quadrature phase shift during an RF power split. The die uses M/A-COM's unique glass process to realize low loss and high Q passive elements while retaining the advantages of overall size and exceptional reproducibility.

These phase shifters are well suited for use in 50 Ω Rx/Tx system applications particularly where small size and repeatability are essential. Typical circuit applications include WiFi and WLAN systems utilizing I/Q networks, signal distribution and/or processing cells.

UTDFN 2mm 8LD Package
(Topview)

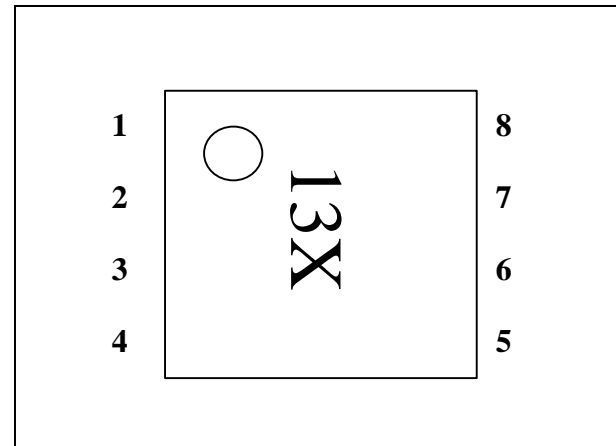

PIN	Function	PIN	Function
1	N/C	8	RF Input
2	Direct Output	7	N/C
3	N/C	6	Coupled Output
4	N/C	5	N/C

Absolute Maximum Ratings¹

Parameter	Maximum Ratings
Operating Temperature	-40 °C to +85 °C
Storage Temperature	-65 °C to +150 °C
RF Incident C.W. Power	+30 dBm C.W.

1. Exceeding these limits may cause permanent damage.

Schematic

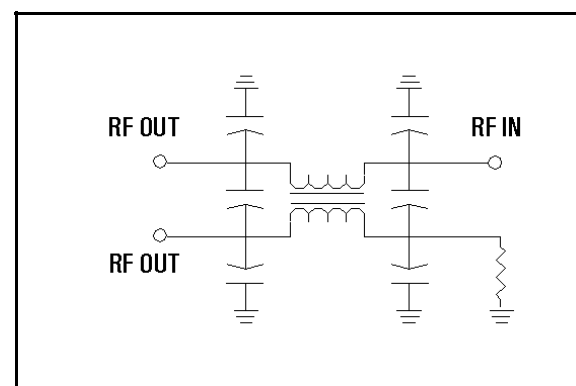

Surface Mount 90° Hybrid
3650 – 4050 MHz

MA4HYB390-1303T
V1

Electrical Specifications @ +25 °C

Parameter	Frequency Range	Units	Min.	Typ.	Max.
Insertion Loss	3900 MHz 3650-4050 MHz	dB		4.6 4.7	4.8 5.4
Phase Balance	3900 MHz 3650-4050 MHz	deg		90.5 91.0	91.0 93.0
Amplitude Balance	3900 MHz 3650-4050 MHz	dB		0.1 0.6	0.5 1.4
Input Return Loss	3900 MHz 3650-4050 MHz	dBm	12.5 11.5	14.6 14.0	
Direct Output Port Return Loss	3900 MHz 3650-4050 MHz	dBm	9.5 9.0	10.4 10.0	
Coupled Output Port Return Loss	3900 MHz 3650-4050 MHz	dBm	7.0 6.0	8.0 7.3	
Output Port to Port Isolation	3900 MHz 3650-4050 MHz	dB	17.6 16.0	21.0 20.0	

Typical Performance Curves

Temperature Legend: (- - - - -40°C, — 25°C, — 85°C)

Direct Port Loss

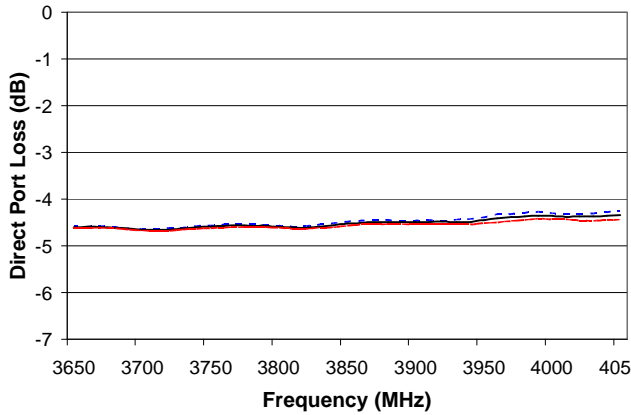

Coupled Port Loss

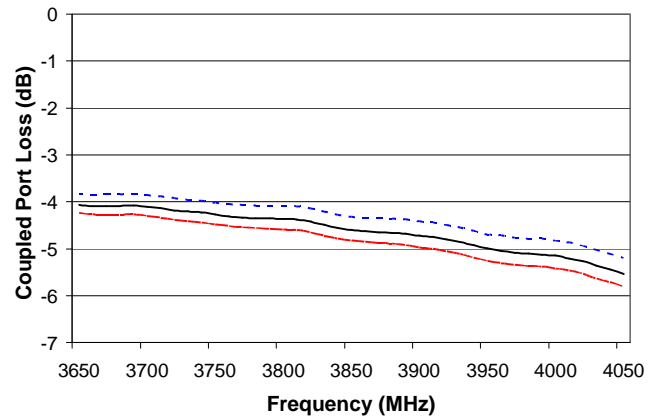

Amplitude Balance

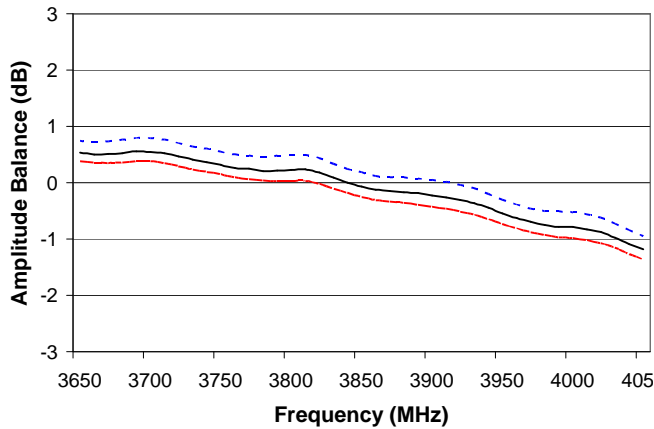

Phase Balance

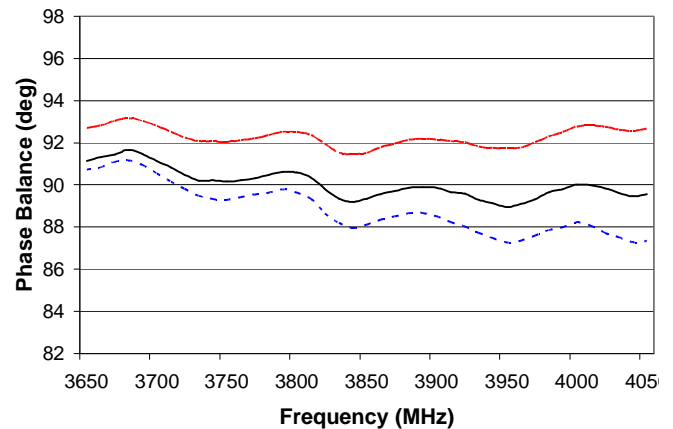

Typical Performance Curves

Temperature Legend: (- - - - - -40°C, — 25°C, — 85°C)

Input Return Loss

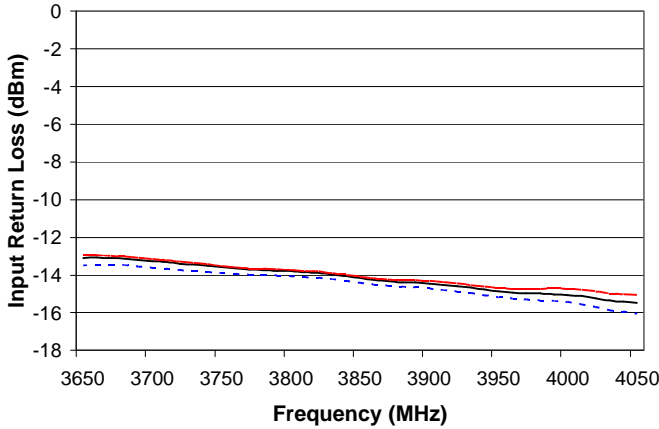

Direct Port Return Loss

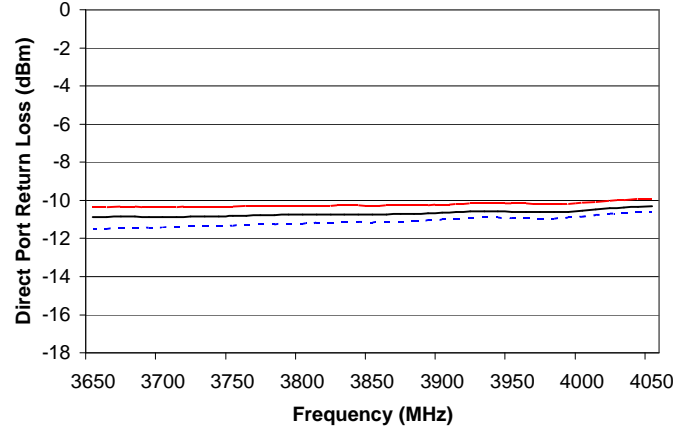

Coupled Port Return Loss

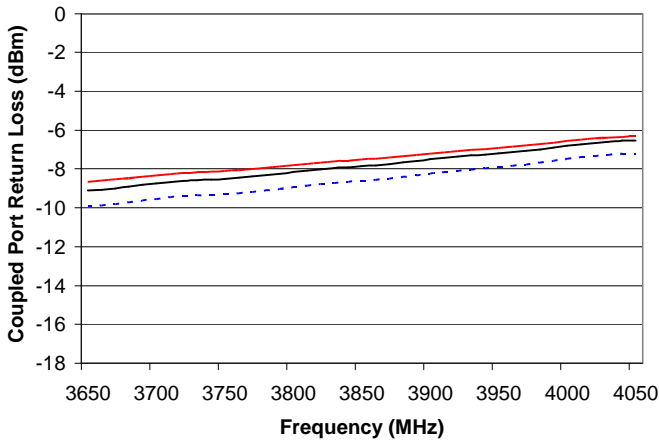

Direct Port to Coupled Port Isolation

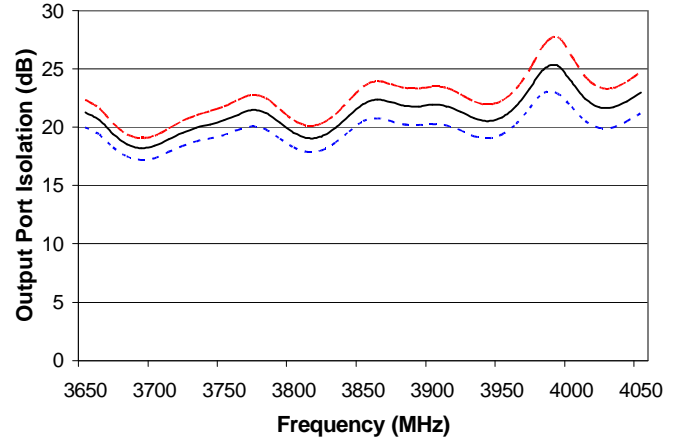

Surface Mount 90° Hybrid
3650 – 4050 MHz

MA4HYB390-1303T
V1

Case Style – UTDFN 2mm 8 Lead

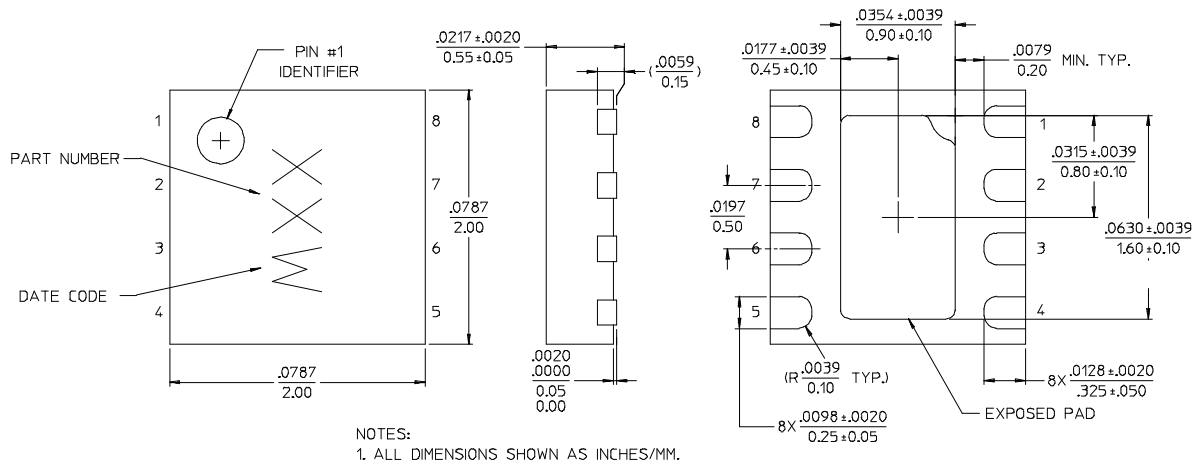

Ordering Information

Part Number	Package
MA4HYB390-1303T	Tape and Reel