

# HFA50PA60CPbF

HEXFRED™

Ultrafast, Soft Recovery Diode

## Features

- Ultrafast Recovery
- Ultrasoft Recovery
- Very Low  $I_{RRM}$
- Very Low  $Q_{rr}$
- Specified at Operating Conditions
- Lead-Free

## Benefits

- Reduced RFI and EMI
- Reduced Power Loss in Diode and Switching Transistor
- Higher Frequency Operation
- Reduced Snubbing
- Reduced Parts Count

## Description

International Rectifier's HFA50PA60C is a state of the art center tap ultra fast recovery diode. Employing the latest in epitaxial construction and advanced processing techniques it features a superb combination of characteristics which result in performance which is unsurpassed by any rectifier previously available. With basic ratings of 600 volts and 25 amps per Leg continuous current, the HFA50PA60C is especially well suited for use as the companion diode for IGBTs and MOSFETs. In addition to ultra fast recovery time, the HEXFRED product line features extremely low values of peak recovery current ( $I_{RRM}$ ) and does not exhibit any tendency to "snap-off" during the  $t_b$  portion of recovery. The HEXFRED features combine to offer designers a rectifier with lower noise and significantly lower switching losses in both the diode and the switching transistor. These HEXFRED advantages can help to significantly reduce snubbing, component count and heatsink sizes. The HEXFRED HFA50PA60C is ideally suited for applications in power supplies and power conversion systems (such as inverters), motor drives, and many other similar applications where high speed, high efficiency is needed.

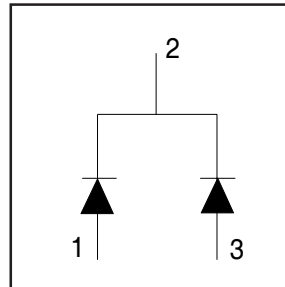

$V_R = 600V$
$V_F(\text{typ.})^* = 1.3V$
$I_{F(AV)} = 25A$
$Q_{rr}(\text{typ.}) = 112nC$
$I_{RRM}(\text{typ.}) = 4.5A$
$t_{rr}(\text{typ.}) = 23ns$
$di_{(rec)M}/dt(\text{typ.})^* = 160A/\mu s$

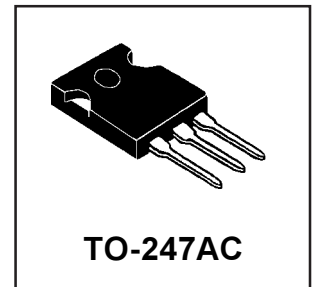

## Absolute Maximum Ratings (per Leg)

	Parameter	Max.	Units
$V_R$	Cathode-to-Anode Voltage	600	V
$I_F @ T_C = 25^\circ C$	Continuous Forward Current		A
$I_F @ T_C = 100^\circ C$	Continuous Forward Current	25	
$I_{FSM}$	Single Pulse Forward Current	225	
$I_{FRM}$	Maximum Repetitive Forward Current	100	
$P_D @ T_C = 25^\circ C$	Maximum Power Dissipation	150	W
$P_D @ T_C = 100^\circ C$	Maximum Power Dissipation	60	
$T_J$	Operating Junction and	-55 to +150	C
$T_{STG}$	Storage Temperature Range		

\* 125°C

**Electrical Characteristics (per Leg) @ T<sub>J</sub> = 25°C (unless otherwise specified)**

	Parameter	Min.	Typ.	Max.	Units	Test Conditions
V <sub>BR</sub>	Cathode Anode Breakdown Voltage	600	—	—	V	I <sub>R</sub> = 100μA
V <sub>FM</sub>	Max Forward Voltage	—	1.3	1.7	V	I <sub>F</sub> = 25A
		—	1.5	2.0		I <sub>F</sub> = 50A See Fig. 1
		—	1.3	1.7		I <sub>F</sub> = 25A, T <sub>J</sub> = 125°C
I <sub>RM</sub>	Max Reverse Leakage Current	—	1.5	20	μA	V <sub>R</sub> = V <sub>R</sub> Rated See Fig. 2
		—	600	2000		T <sub>J</sub> = 125°C, V <sub>R</sub> = 0.8 x V <sub>R</sub> Rated
C <sub>T</sub>	Junction Capacitance	—	55	100	pF	V <sub>R</sub> = 200V See Fig. 3
L <sub>S</sub>	Series Inductance	—	12	—	nH	Measured lead to lead 5mm from package body

**Dynamic Recovery Characteristics @ T<sub>J</sub> = 25°C (unless otherwise specified)**

	Parameter	Min	Typ	Max	Units	Test Conditions	
t <sub>rr</sub>	Reverse Recovery Time	—	23	—	ns	I <sub>F</sub> = 1.0A, di <sub>F</sub> /dt = 200A/μs, V <sub>R</sub> = 30V T <sub>J</sub> = 25°C	
t <sub>rr1</sub>	See Fig. 5, 10	—	50	75			T <sub>J</sub> = 125°C
t <sub>rr2</sub>		—	105	160			I <sub>F</sub> = 25A
I <sub>RRM1</sub>	Peak Recovery Current	—	4.5	10	A	V <sub>R</sub> = 200V	
I <sub>RRM2</sub>	See Fig. 6	—	8.0	15			T <sub>J</sub> = 125°C
Q <sub>rr1</sub>	Reverse Recovery Charge	—	112	375	nC	di <sub>F</sub> /dt = 200A/μs	
Q <sub>rr2</sub>	See Fig. 7	—	420	1200			T <sub>J</sub> = 125°C
di <sub>(rec)M</sub> /dt1	Peak Rate of Fall of Recovery Current	—	250	—	A/μs	T <sub>J</sub> = 25°C	
di <sub>(rec)M</sub> /dt2	During t <sub>b</sub> See Fig. 8	—	160	—			T <sub>J</sub> = 125°C

**Thermal - Mechanical Characteristics**

	Parameter	Min	Typ	Max	Units
T <sub>lead</sub> ①	Lead Temperature	—	—	300	°C
R <sub>thJC</sub>	Junction-to-Case, Single Leg Conducting	—	—	0.83	K/W
	Junction-to-Case, Both Legs Conducting	—	—	0.42	
R <sub>thJA</sub> ②	Thermal Resistance, Junction to Ambient	—	—	40	
R <sub>thCS</sub> ③	Thermal Resistance, Case to Heat Sink	—	0.25	—	
Wt	Weight	—	6.0	—	g
		—	0.21	—	(oz)
	Mounting Torque	6.0	—	12	Kg-cm
		5.0	—	10	lbf•in

① 0.063 in. from Case (1.6mm) for 10 sec

② Typical Socket Mount

③ Mounting Surface, Flat, Smooth and Greased

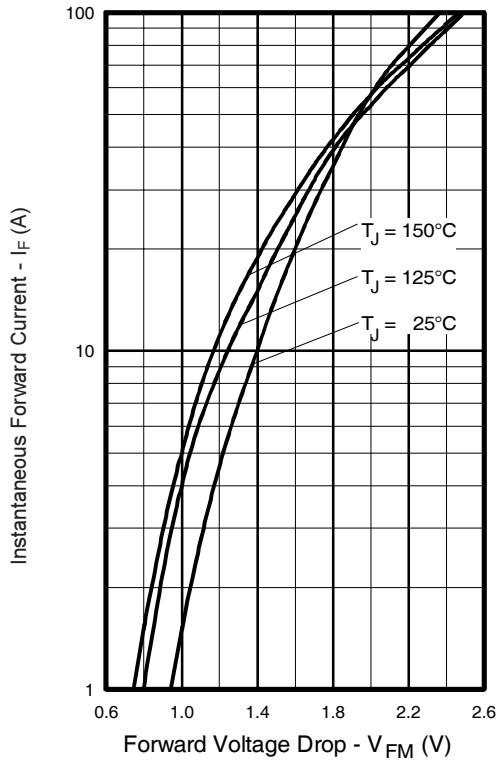

**Fig. 1** - Maximum Forward Voltage Drop vs. Instantaneous Forward Current, (per Leg)

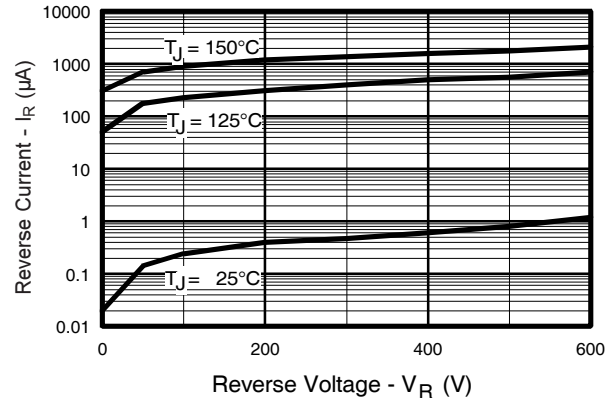

**Fig. 2** - Typical Reverse Current vs. Reverse Voltage, (per Leg)

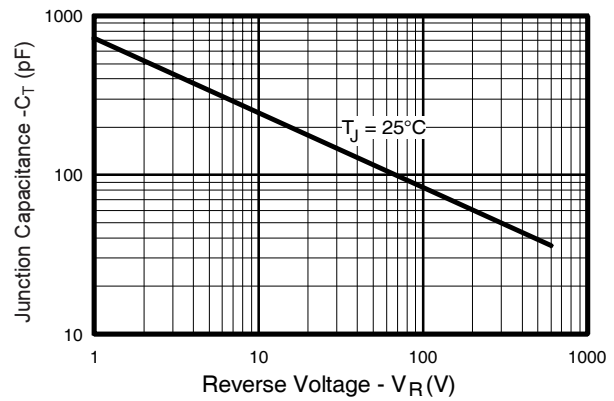

**Fig. 3** - Typical Junction Capacitance vs. Reverse Voltage, (per Leg)

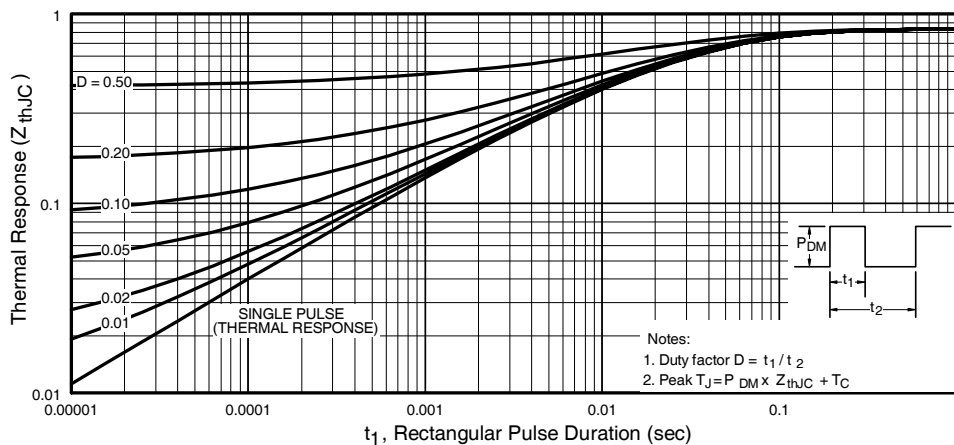

**Fig. 4** - Maximum Thermal Impedance  $Z_{thJC}$  Characteristics, (per Leg)

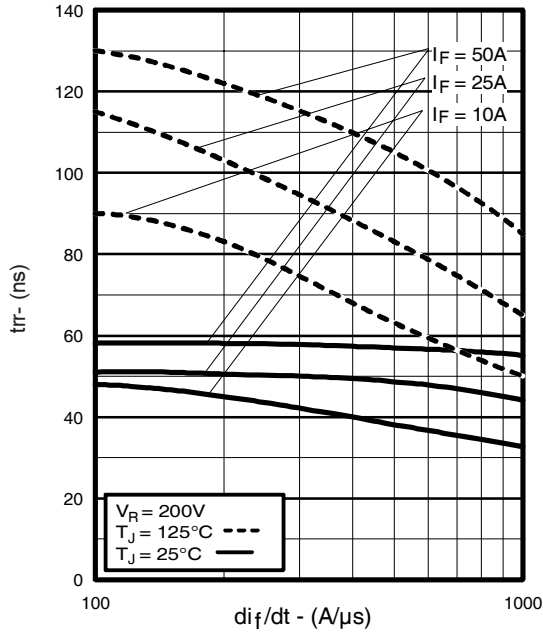

Fig. 5 - Typical Reverse Recovery Time vs.  $di_f/dt$ , (per Leg)

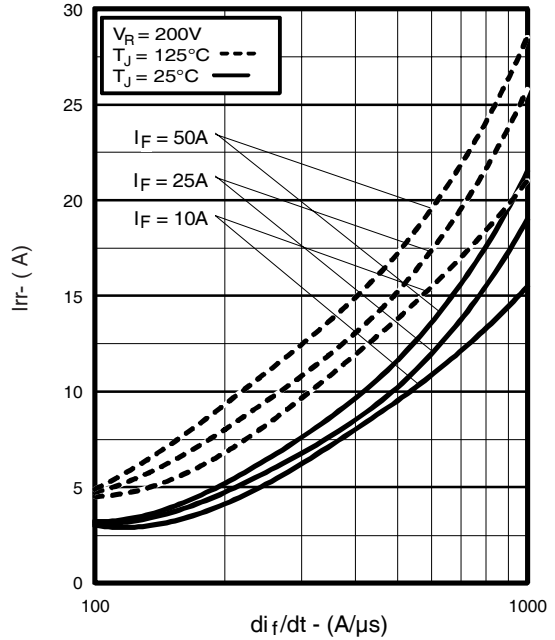

Fig. 6 - Typical Recovery Current vs.  $di_f/dt$ , (per Leg)

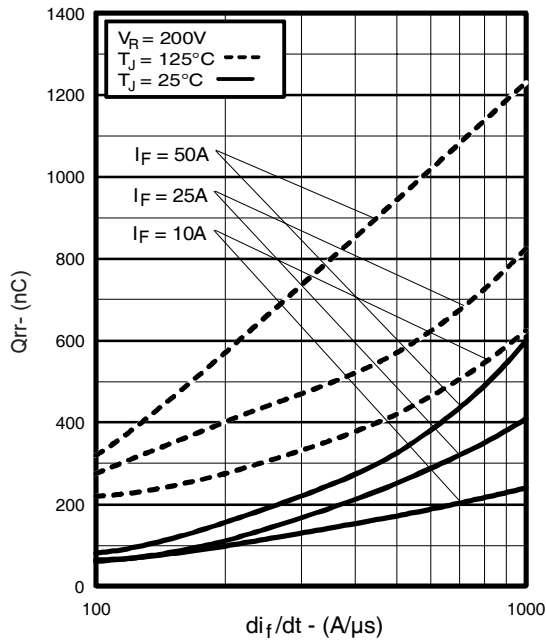

Fig. 7 - Typical Stored Charge vs.  $di_f/dt$ , (per Leg)

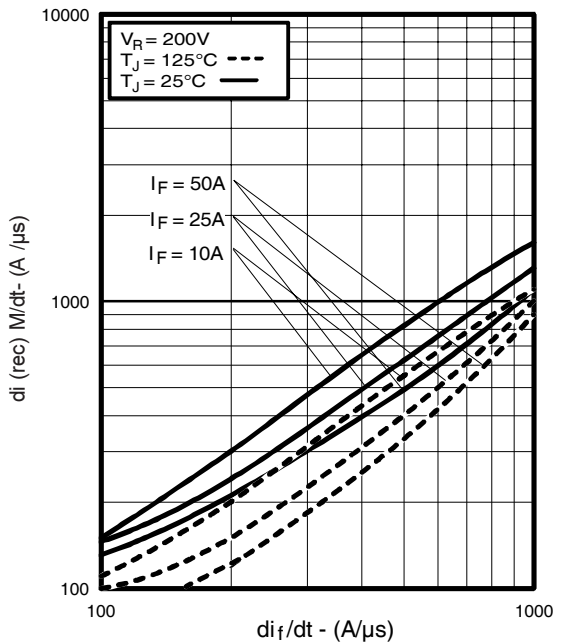
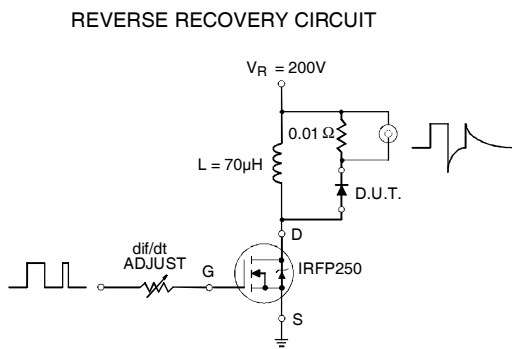
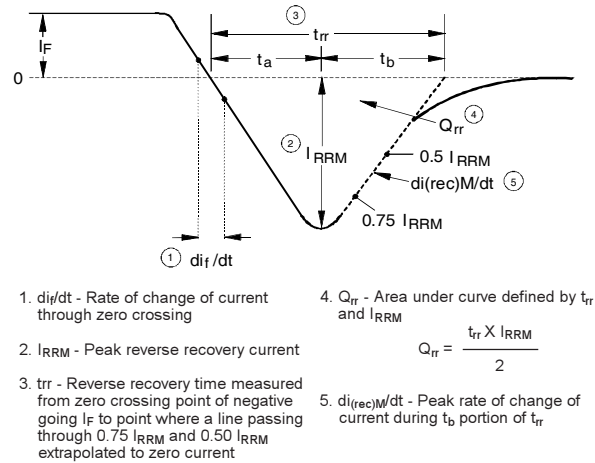

Fig. 8 - Typical  $di_{(rec)}M/dt$  vs.  $di_f/dt$ , (per Leg)



**Fig. 9 - Reverse Recovery Parameter Test Circuit**



**Fig. 10 - Reverse Recovery Waveform and Definitions**

**Ordering Information Table**

Device Code					
<b>HF</b>	<b>A</b>	<b>50</b>	<b>PA</b>	<b>60</b>	<b>C</b>
①	②	③	④	⑤	⑥
<b>1</b>	- Hexfred Family				
<b>2</b>	- Process Designator	A	= subs. elec. irradi.		
		B	= subs. Platinum		
<b>3</b>	- Current Rating	(50	= 50A)		
<b>4</b>	- Package Outline	(PA	= TO-247, 3 pins)		
<b>5</b>	- Voltage Rating	(60	= 600V)		
<b>6</b>	- Configuration	(C	= Center Tap Common Cathode)		
Note: "PbF" suffix at the end of the part number indicates Lead-Free.					

HFA50PA60CPbF

International  
**IOR** Rectifier

TO-247AC Package Outline

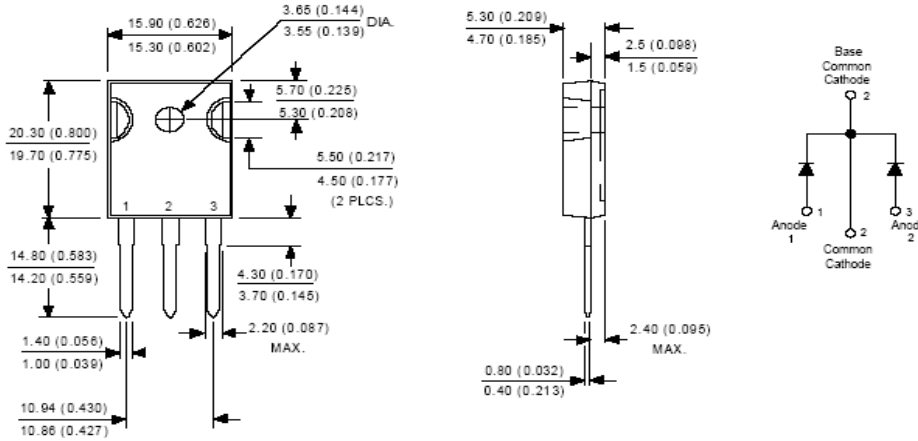

Conform to JEDEC outline TO-247AC (TO-3P)  
Dimensions in millimeters and (inches)

TO-247AC Part Marking Information

EXAMPLE: THIS IS A HFA16PA60C  
WITH ASSEMBLY  
LOT CODE 5657  
ASSEMBLED ON WW 35, 2000  
IN ASSEMBLY LINE "H"

Note: "P" in the beginning of date code  
indicates "Lead-Free"

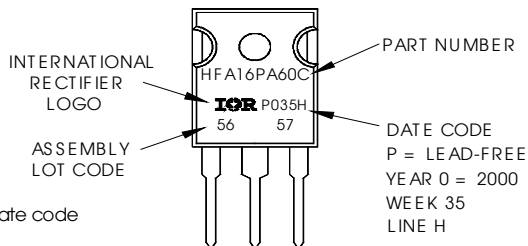

Data and specifications subject to change without notice.  
This product has been designed and qualified for Industrial Level.  
Qualification Standards can be found on IR's Web site.

International  
**IOR** Rectifier

IR WORLD HEADQUARTERS: 233 Kansas St., El Segundo, California 90245, USA Tel: (310) 252-7105  
TAC Fax: (310) 252-7309  
Visit us at [www.irf.com](http://www.irf.com) for sales contact information. 10/04