



AKD4706-A

Evaluation board Rev.1 for AK4706

GENERAL DESCRIPTION

AKD4706-A is an evaluation board for quickly evaluating the AK4706, 2ch DAC with AV SCART switch. Evaluation requires audio/video analog analyzers/generators, a digital audio signal source, and a power supply. AKM's ADC evaluation board can be also used for the audio source. Also included is a AK4112B digital audio interface receiver which receives S/PDIF compatible audio data. The digital audio data is available via optical connector or BNC.

AKD4706-A --- Evaluation board for AK4706
 (Cable for connecting with printer port of IBM-AT compatible PC and a control software are enclosed with board. This control software dose not supports Windows NT.)

FUNCTION

- BNC connectors for analog audio input/output
- BNC connectors for SD/HD video input/output
- On-board clock generator
- BNC connector for an external clock input
- Compatible with 2 types of digital interface
 1. Serial interface: Direct interface with evaluation boards for AKM's A/D converter evaluation boards.
 2. S/PDIF: On-board AK4112BVF as DIR that accepts optical input or BNC input
- 10pin header for serial control interface

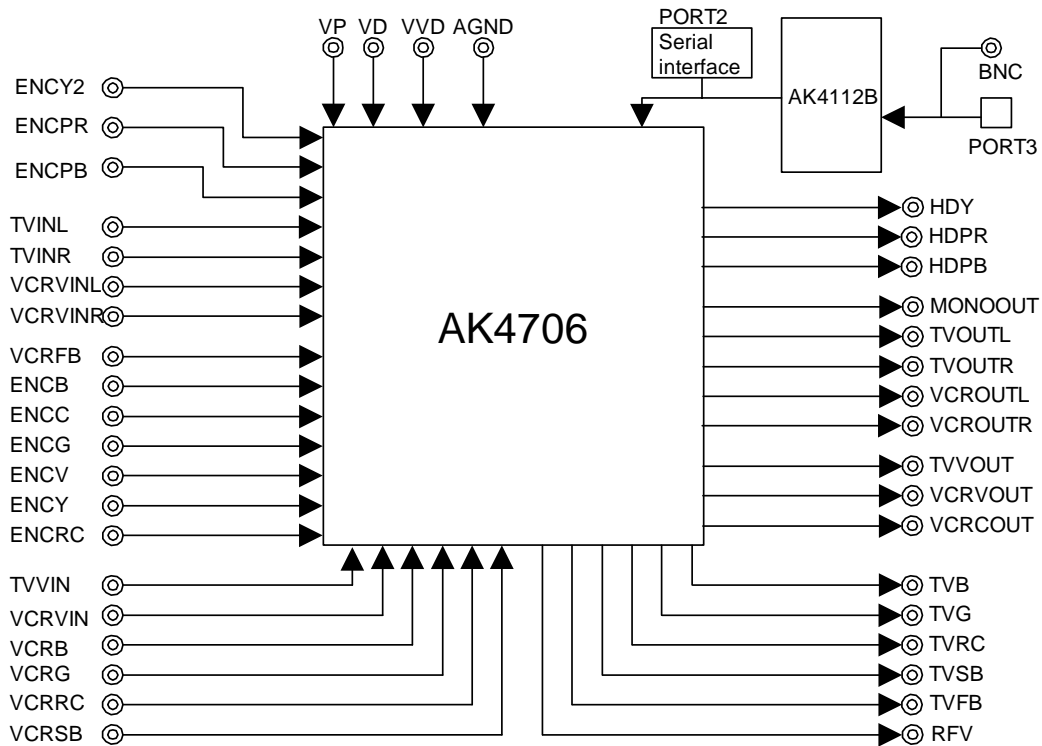

Figure 1. AKD4706-A Block Diagram

- Circuit diagram and PCB layout are attached at the end of this manual.

■ Operation sequence

- 1) Set up the power supply lines. (Note 1)

[+12V]	(Orange)	= +12V
[+5V]	(Red)	= +5.0V (Note 2)
[D5V]	(Red)	= +5.0V (Note 3)
[VVD]	(Red)	= +5.0V (Note 4)
[AGND]	(Black)	= 0V
[DGND]	(Black)	= 0V

Note: 1. Each supply line should be distributed from the power supply unit.

2. JP2 (REG) should be open when the “+5V” jack is used.

3. JP1 (D-A) should be open when the “D5V” jack is used.

4. JP22 (REG) should be open when the “VVD” jack is used.

- 2) Set-up the evaluation modes, jumper pins and DIP-switches. (Refer next sections.)
- 3) Connect the PORT1 (=μP-I/F) with PC by the enclosed 10-wire flat cable.
- 4) Set up the PC and execute the enclosed control software. (Refer “CONTROL SOFTWARE MANUAL”.)
- 5) Turn the power on.
- 6) Reset the AK4706 once by bringing the SW1 (PDN) “L”, and return it to “H”.

■ Evaluation mode

1) S/PDIF mode (Optical Link or BNC: default)

When the CM0 (DIP-switch S1_1 on board) is “L”, the AK4112B (DIR) generates MCLK, BICK, LRCK and SDATA from the received bit stream through PORT3 (TORX176: optical link) or J2 (BNC). This mode is used for the evaluation using CD test disk. The PORT2 (EXT) should be open.

1)-1. DIP-switch set-up

No.	CM0	DIF1	DIF0	Audio Data Format of AK4112B
1	L	L	L	16bit LSB justified
2	L	L	H	18bit LSB justified
3	L	H	L	24bit MSB justified
4	L	H	H	24bit I ² S

Default

Table 1. DIP-switch set-up

Much the data format of the AK4706 via I²C-bus control as following notes.

1)-2. Jumper pins set up

Input	JP8 (RX)	JP3 (EXT)	JP4 (MCLK)	JP5 (BICK)	JP6 (SDTI)	JP7 (LRCK)
TORX	TORX	Open	Short	Short	Short	Short
BNC	BNC	Open	Short	Short	Short	Short

Table 2. Jumper pins set up

2) On-board X'tal mode/ Feeding external MCLK via BNC

When the CM0 (DIP-switch S1_1 on board) is "H", the AK4112B generates MCLK, BICK and LRCK from on-board X'tal or external clock form J1. SDATA should be fed via PORT2.

2)-1. DIP-switch set-up

No.	CM0	DIF1	DIF0
1	"H"	Don't care	Don't care

Table 3. DIP-switch set-up

2)-2. Jumper pins set up

Mode	JP3 (EXT)	JP4 (MCLK)	JP5 (BICK)	JP6 (SDTI)	JP7 (LRCK)
On-board X'tal	Open	Short	Short	Open	Short
External clock via BNC connector J1	Short	Short	Short	Short	Short

Table 4. Jumper pins set up

3) Feeding all clocks from external

Under the following set-up, all external signals can be fed to the AK4706 through POTR1 (EXT). The AKM's evaluation board for ADC can be used.

3)-1. DIP-switch set-up

No.	CM0	DIF1	DIF0
1	Don't care	Don't care	Don't care

Table 5. DIP-switch set-up

3)-2. Jumper pins set up

JP3 (EXT)	JP4 (MCLK)	JP5 (BICK)	JP6 (SDTI)	JP7 (LRCK)
Open	Open	Open	Open	Open

Table 6. Jumper pins set up

4) Set-up of S bit="0/1"

Mode	JP13 (ENCRC)	JP14 (ENCRC)	JP15 (VCRFB)	Default
SCART	S="0"	Open	Don't care	
S1/S2	S="1"	Short	ENCRC	

Table 7. Set-up of Input for ENCRC

Mode	JP9 (VCRRC)	JP10 (VCRRC)	JP11 (VCRRC)	JP12 (VCRSB)	Default
SCART	S="0"	Open	"I"	Don't care	
S1/S2	S="1"	Short	"I"	VCRRC	

Table 8. Set-up of Input for VCRRC

Mode	JP17 (VCRC)	JP18 (VCRC)	Default
SCART	S="0"	Open	
S1/S2	S="1"	Short	

Table 9. Set-up of Output for VCRC

Mode	JP20 (TVRC)	JP21 (TVRC)	Default
SCART	S="0"	Open	
S1/S2	S="1"	Short	

Table 10. Set-up of Output for TVRC

■ DIP-switch (S1) List

No.	Switch Name	Default	Function
1	CM0	OFF	Refer the "■ Evaluation mode"
2	DIF0	OFF	
3	DIF2	OFF	
4	-	OFF	(Reserved)
5	-	OFF	(Reserved)

Table 11. DIP-switch list

■ Jumper List

No.	Jumper Name	Function
1	D-A	Power supply source set-up for digital section of AKD4706. Open: from the "D5V" Jack. (default) Short: from the regulator or the "+5V" Jack. Don't connect anything to the "D5V" Jack. (default)
2	REG	Power supply source set-up for VD of AK4706. Open: from the "+5V" Jack. Short: from the regulator. Don't connect anything the "+5V" Jack. (default)
3	EXT	MCLK source set-up when CM0="H". Short: X'tal. (default). Open: External clock via BNC (J1). Remove the on-board X'tal.
4, 5, 6, 7	MCLK, BICK, LRCK, SDTI	Clock source set-up Short: Connect the DIR (AK4112B). (default) Open: Separate the DIR. Supply clocks via Port1.
8	RX	S/PDIF's port set-up when CM0="L". TORX: Optical connector PORT2. (default) BNC: BNC connector J2.
9	VCRRC	Set-up of S="0/1". S="0": S bit="0". (default) S="1": S bit="1".
10	VCRRC	Set-up of S="0/1". Open: S bit="0". (default) Short: S bit="1".
11	VCRRC	Input Selection for VCRRC. "I" side: Input to VCRRC from VCRRC jack. (default) "I/O" side: Input to VCRC from VCRC jack. (Note: Refer CIO bit of AK4706)
12	VCRSB	Input Selection for VCRRC or VCRSB. VCRRC: Input to VCRRC. VCRSB: Input to VCRSB. (default)
13	ENCRC	Set-up of S="0/1". S="0": S bit="0". (default) S="1": S bit="1".
14	ENCRC	Set-up of S="0/1". Open: S bit="0". (default) Short: S bit="1".
15	VCRFB	Input Selection for ENCRC or VCRFB. ENCRC: Input to ENCRC. VCRFB: Input to VCRFB. (default)
16	TVSB	Output Selection for TVSB. Open: Output to TVSB. (default) Short: Output to VCRCOUT.
17	VCRC	Set-up of S="0/1". S="0": S bit="0". (default) S="1": S bit="1".
18	VCRC	Set-up of S="0/1". Open: S bit="0". (default) Short: S bit="1".
19	TVFB	Output Selection for TVFB. Open: Output to TVFB. (default) Short: Output to TVRC.
20	TVRC	Set-up of S="0/1". S="0": S bit="0". (default) S="1": S bit="1".
21	TVRC	Set-up of S="0/1". Open: S bit="0". (default) Short: S bit="1"
22	REG	Power supply source set-up for VVD of AK4706. Open: from the "VVD" Jack. Short: from the regulator. Don't connect anything the "VVD" Jack. (default)

Table 12. Jumper list

■ **Serial Control**

The AK4706 can be controlled via the printer port (parallel port) of IBM-AT compatible PC. Connect PORT1 (μP-IF) with PC by 10 wire flat cable packed with the AKD4706.

Be careful connector direction. Flat cable should be connected 10-pin header, red line put on 10pin header 5 and 6 pin.

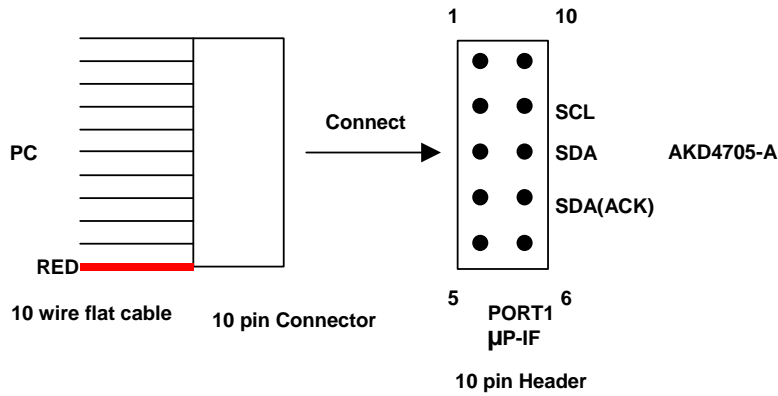

Figure 2. Connection of 10 pin flat cable for PORT1

■ **The indication content for LED**

LED turns on during each output is “H”.

[LE1] Indicates unlock or parity error of S/PDIF. Connected to the ERF pin of DIR (AK4112B).
(Normally off.)

[LE2] Indicates the validity status of S/PDIF. Connected to the V pin of DIR (AK4112B).
(Normally off.)

■ **Toggle switch (SW1 on board) operation**

“H”: AK4706 is Active.

“L”: AK4706 is Powered Down.

(Note; when the power of AKD4706-A is ON at first, SW1 should be switched from “L” to “H”.)

Control Software Manual

■ Set-up of evaluation board and control software

1. Set up the AKD4706 according to previous term.
2. Connect IBM-AT compatible PC with AKD4706-A by 10-line type flat cable (packed with AKD4706-A). Take care of the direction of 10pin header. (Please install the driver in the CD-ROM when this control software is used on Windows 2000/XP. Please refer "Installation Manual of Control Software Driver by AKM device control software". In case of Windows95/98/ME, this installation is not needed. This control software does not operate on Windows NT.)
3. Insert the CD-ROM labeled "AK4706 Evaluation Kit" into the CD-ROM drive.
4. Access the CD-ROM drive and double-click the icon of "akd4706.exe" to set up the control program.
5. Then please evaluate according to the follows.

■ Operation flow

Keep the following flow.

1. Set up the control program according to explanation above.
2. Click "Port Reset" button.
3. Click "Write default" button

■ Explanation of each buttons

1. [Port Reset] : Set up the USB interface board (AKDUSBIF-A) when using the board.
2. [Write default] : Initialize the register of AK4706.
3. [All Write] : Write all registers that is currently displayed.
4. [Function1] : Dialog to write data by keyboard operation.
5. [Function2] : Dialog to write data by keyboard operation.
6. [Function3] : The sequence of register setting can be set and executed.
7. [Function4] : The sequence that is created on [Function3] can be assigned to buttons and executed.
8. [Function5] : The register setting that is created by [SAVE] function on main window can be assigned to buttons and executed.
9. [SAVE] : Save the current register setting.
10. [OPEN] : Write the saved values to all register.
11. [Write] : Dialog to write data by mouse operation.

■ Indication of data

Input data is indicated on the register map. Red letter indicates "H" or "1" and blue one indicates "L" or "0". Blank is the part that is not defined in the datasheet.

■ **Explanation of each dialog**

1. [Write Dialog]: Dialog to write data by mouse operation

There are dialogs corresponding to each register.

Click the [Write] button corresponding to each register to set up the dialog. If you check the check box, data becomes “H” or “1”. If not, “L” or “0”.

If you want to write the input data to the AK4706, click [OK] button. If not, click [Cancel] button.

2. [Function1 Dialog] : Dialog to write data by keyboard operation

Address Box: Input registers address in 2 figures of hexadecimal.

Data Box: Input registers data in 2 figures of hexadecimal.

If you want to write the input data to the AK4706, click [OK] button. If not, click [Cancel] button.

3. [Function2 Dialog] : Dialog to evaluate DATT

There are dialogs corresponding to register of 02h.

Address Box: Input registers address in 2 figures of hexadecimal.

Start Data Box: Input starts data in 2 figures of hexadecimal.

End Data Box: Input end data in 2 figures of hexadecimal.

Interval Box: Data is written to AK4706 by this interval.

Step Box: Data changes by this step.

Mode Select Box:

If you check this check box, data reaches end data, and returns to start data.

[Example] Start Data = 00, End Data = 09

Data flow: 00 01 02 03 04 05 06 07 08 09 09 08 07 06 05 04 03 02 01 00

If you do not check this check box, data reaches end data, but does not return to start data.

[Example] Start Data = 00, End Data = 09

Data flow: 00 01 02 03 04 05 06 07 08 09

If you want to write the input data to the AK4706, click [OK] button. If not, click [Cancel] button.

4. [SAVE] and [OPEN]

4-1. [SAVE]

All of current register setting values displayed on the main window are saved to the file. The extension of file name is “.akr”.

<Operation flow>

- (1) Click [SAVE] Button.
- (2) Set the file name and click [SAVE] Button. The extension of file name is “.akr”.

4-2. [OPEN]

The register setting values saved by [SAVE] are written to the AK4706. The file type is the same as [SAVE].

<Operation flow>

- (1) Click [OPEN] Button.
- (2) Select the file (*.akr) and Click [OPEN] Button.

5. [Function3 Dialog]

The sequence of register setting can be set and executed.

(1) Click [F3] Button. The following is displayed.

(2) Set the control sequence.

Set the address, Data and Interval time. Set “-1” to the address of the step where the sequence should be paused.

(3) Click [START] button. Then this sequence is executed.

The sequence is paused at the step of Interval="-1". Click [START] button, the sequence restarts from the paused step.

This sequence can be saved and opened by [SAVE] and [OPEN] button on the Function3 window. The extension of file name is “aks”.

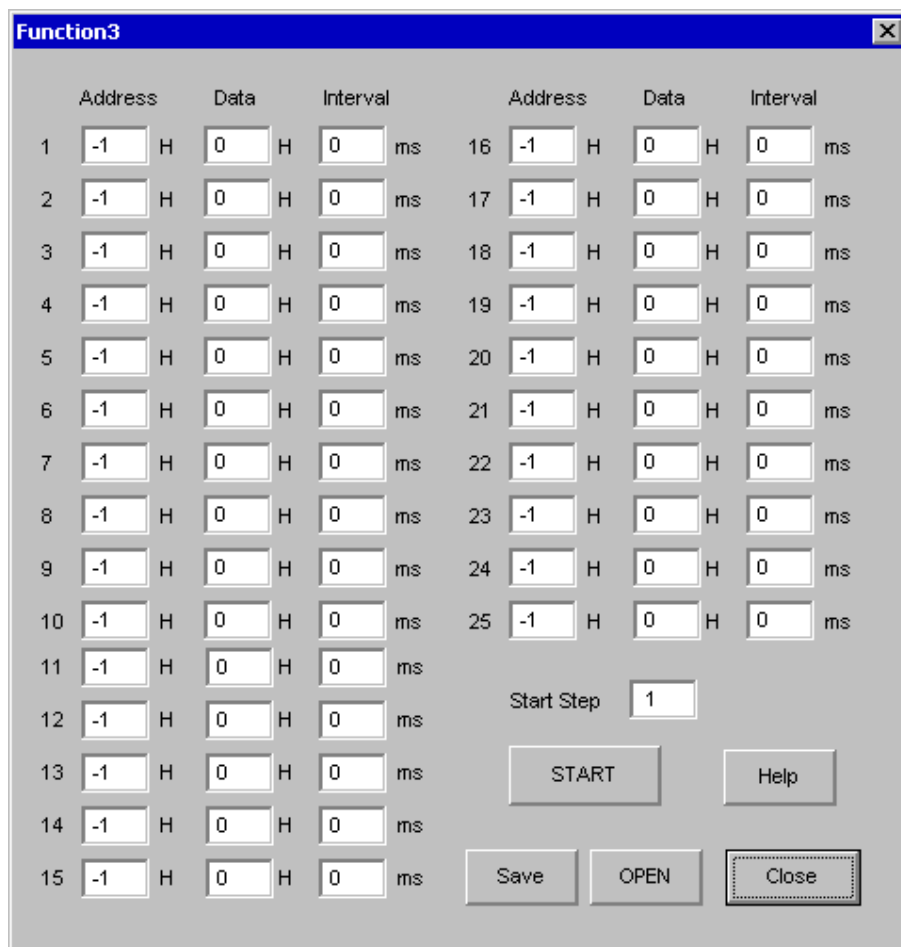

Figure 1. Window of [F3]

6. [Function4 Dialog]

The sequence file (*.aks) saved by [Function3] can be listed up to 10 files, assigned to buttons and then executed. When [F4] button is clicked, the window as shown in Figure 2 opens.

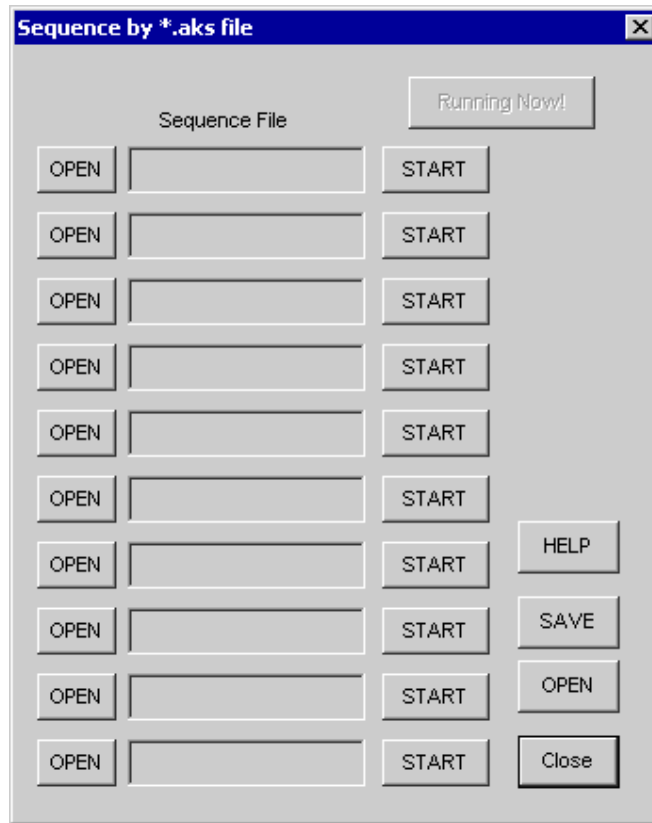

Figure 2. [F4] window

6-1. [OPEN] buttons on left side and [START] buttons

(1) Click [OPEN] button and select the sequence file (*.aks) saved by [Function3].

The sequence file name is displayed as shown in Figure 3. (In case that the selected sequence file name is "DAC_Stereo_ON.aks")

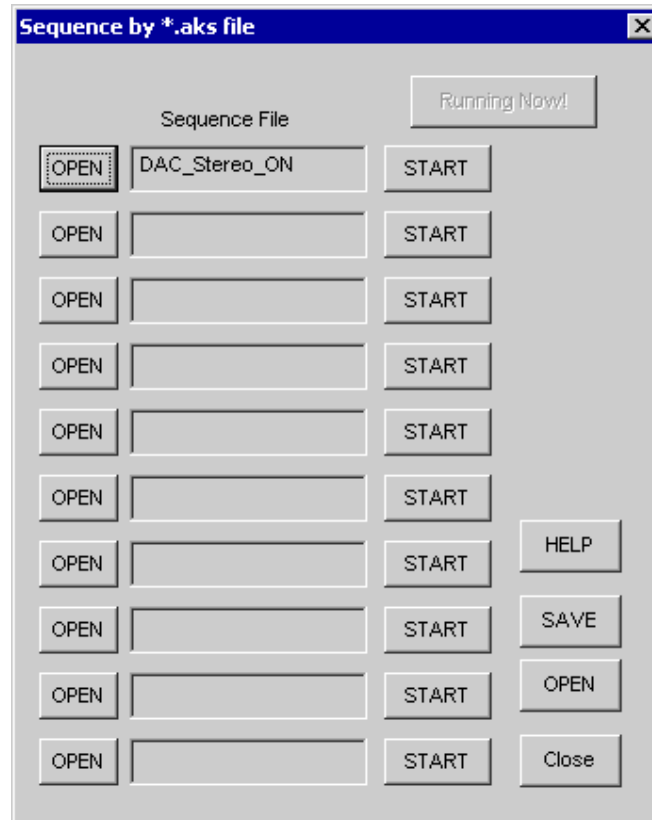

Figure 3. [F4] window(2)

(2) Click [START] button, then the sequence is executed.

6-2. [SAVE] and [OPEN] buttons on right side

[SAVE] : The name assign of sequence file displayed on [Function4] window can be saved to the file. The file name is "*.ak4".

[OPEN] : The name assign of sequence file (*.ak4) saved by [SAVE] is loaded.

6-3. Note

- (1) This function doesn't support the pause function of sequence function.
- (2) All files used by [SAVE] and [OPEN] function on right side need to be in the same folder.
- (3) When the sequence is changed in [Function3], the sequence file (*.aks) should be loaded again in order to reflect the change.

7. [Function5 Dialog]

The register setting file(*.akr) saved by [SAVE] function on main window can be listed up to 10 files, assigned to buttons and then executed. When [F5] button is clicked, the window as shown in Figure 4 opens.

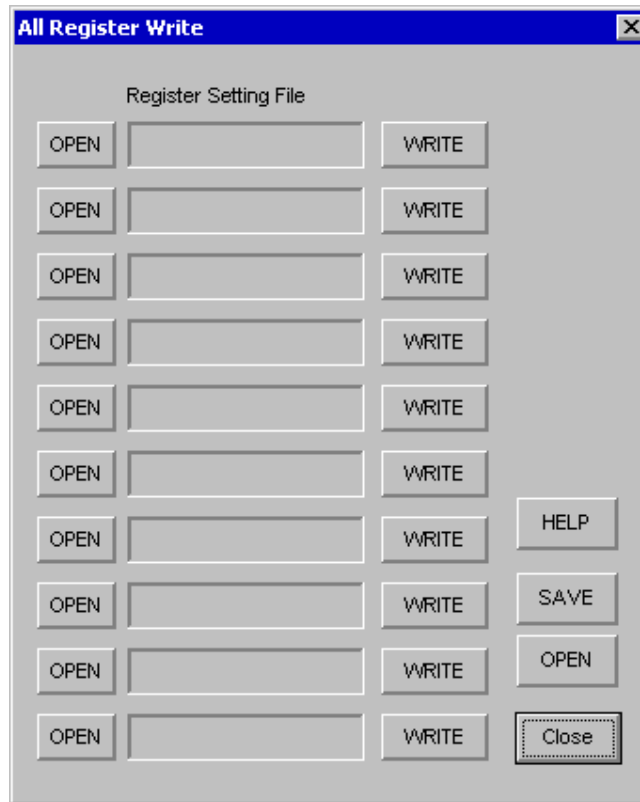

Figure 4. [F5] window

7-1. [OPEN] buttons on left side and [WRITE] button

(1) Click [OPEN] button and select the register setting file (*.akr).

The register setting file name is displayed as shown in Figure 5. (In case that the selected file name is "DAC_Output.akr")

(2) Click [WRITE] button, then the register setting is executed.

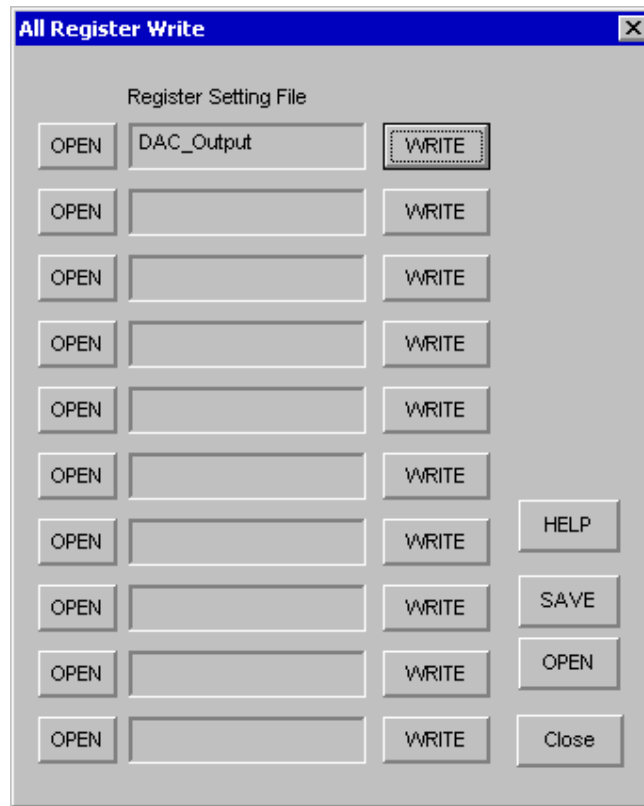

Figure 5. [F5] windows(2)

7-2. [SAVE] and [OPEN] buttons on right side

[SAVE] : The name assign of register setting file displayed on [Function5] window can be saved to the file. The file name is “*.ak5”.

[OPEN] : The name assign of register setting file(*.ak5) saved by [SAVE] is loaded.

7-3. Note

- (1) All files used by [SAVE] and [OPEN] function on right side need to be in the same folder.
- (2) When the register setting is changed by [SAVE] Button on the main window, the register setting file (*.akr) should be loaded again in order to reflect the change.

MEASUREMENT RESULTS

■ Audio

[Measurement condition]

- Measurement unit: Audio Precision System two Cascade
- MCLK : 256fs
- BICK : 64fs
- fs : 44.1kHz
- BW : 10Hz~20kHz
- Bit : 24bit
- Power Supply : VD1=VD2=5V, VDD1=VDD2=VDD3=VDD4=5V, VP=12V
- Interface : DIR
- Temperature : Room
- Volume#0=Volume#1=0dB
- Measurement signal line path: DAC → Volume#0 → Volume#1 → TVOUTL/R

Parameter	Input signal	Measurement filter	Results [dB]
S/(N+D) at 2Vrms Output	1kHz, 0dBFS	20kLPF	93.8
DR	1kHz, -60dBFS	22kLPF, A-weighted	97.1
S/N	“0” data	22kLPF, A-weighted	97.5

■ Video

[Measurement condition]

- Signal Generator : Sony Tectonics TG2000
- Measurement unit: Sony Tectonics VM700T / Agilent 4395A
- Power Supply : VD1=VD2=5V, VDD1=VDD2=VDD3=VDD4=5V, VP=12V
- Interface : BNC
- Temperature : Room
- Measurement signal line path: ENCV → TVVOUT, ENCRC → TVRC, ENCY2 → HDY

Parameter	Measurement conditions	Results	Unit
S/N	Input = 0% flat field Filter = Uni-weighted, BW= 15kHz to 5MHz	72.5	dB
Crosstalk	Input = 100%red(ENCR), Measured at TVVOUT	-50.1	dB
DG	Input = Modulated Lamp	0.58	%
DP	Input = Modulated Lamp	0.80	deg.

Plots (Audio)
AKM

AK4706 FFT fs=44.1kHz, fin=1kHz, 0dB input
VP=12V, VD1=VD2=VVD1=VVD2=VVD3=VVD4=5V

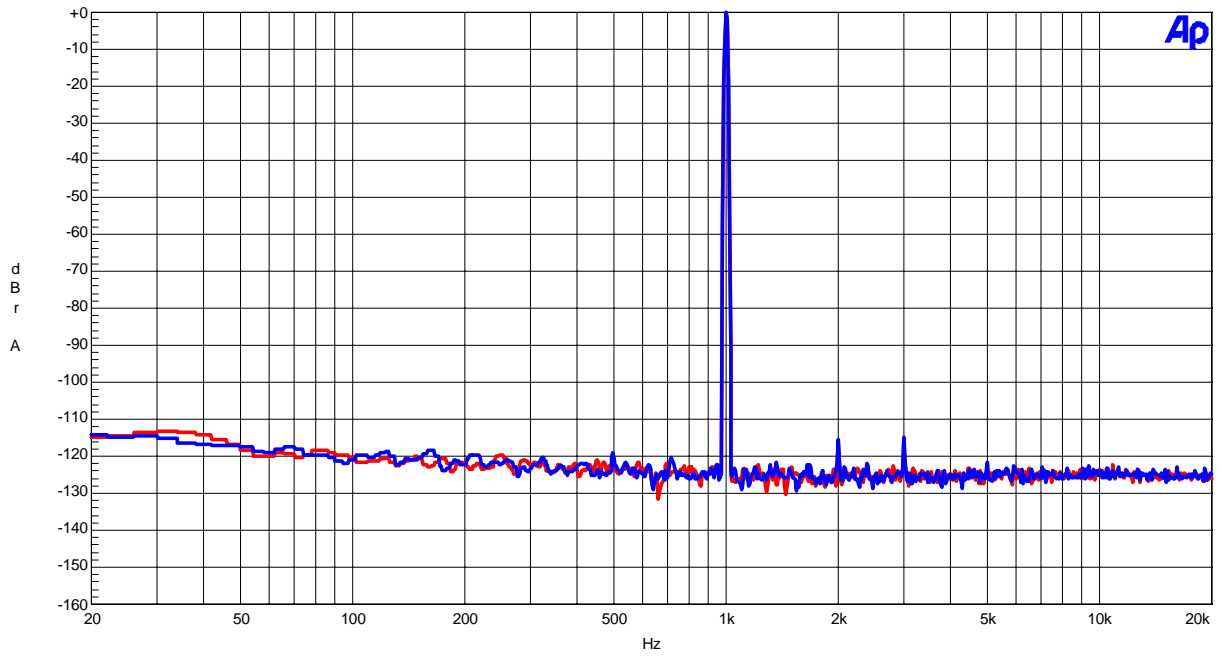

Figure1-1. FFT (fin=1kHz Input Level=0dBFS)

AKM

AK4706 FFT fs=44.1kHz, fin=1kHz, -60dB input
VP=12V, VD1=VD2=VVD1=VVD2=VVD3=VVD4=5V

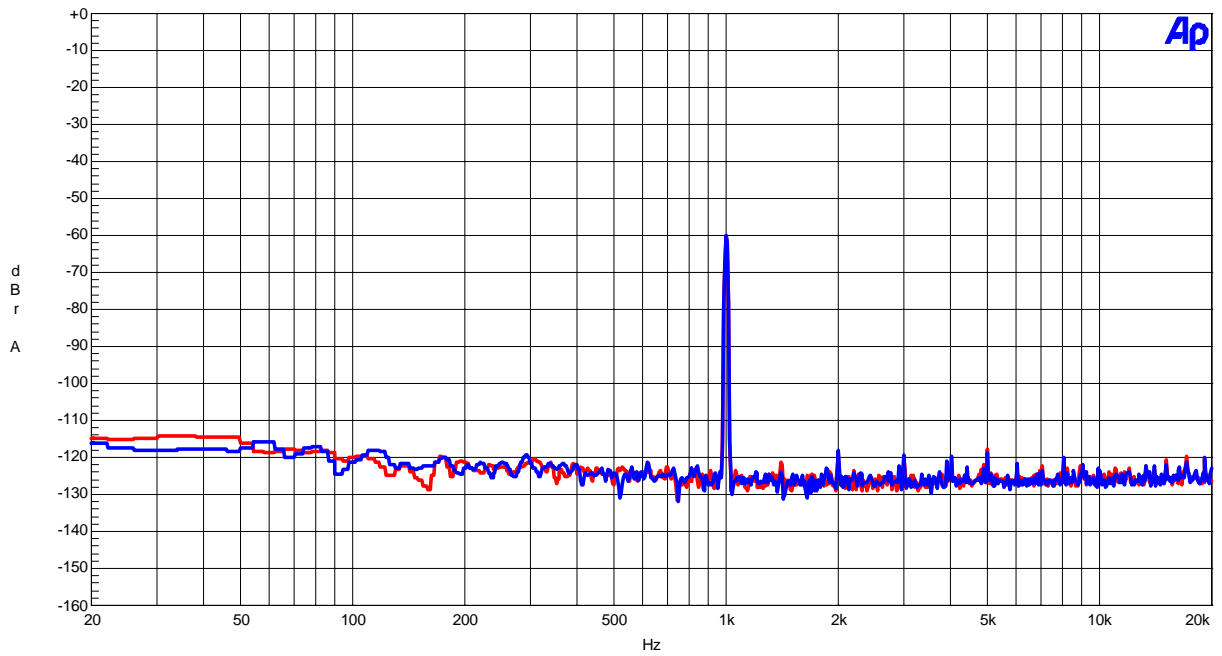

Figure1-2. FFT (fin=1kHz Input Level=-60dBFS)

AKM

AK4706 FFT fs=44.1kHz, fin=1kHz, No input
VP=12V, VD1=VD2=VVD1=VVD2=VVD3=VVD4=5V

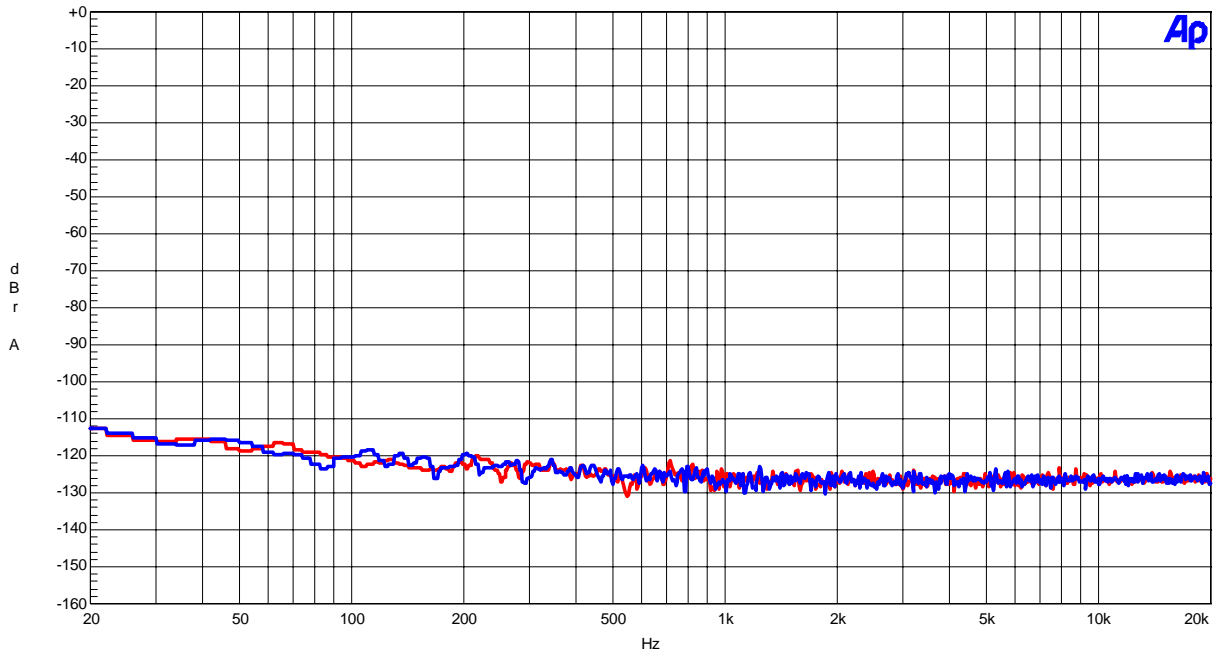

Figure1-3. FFT (Noise Floor)

AKM

AK4706 Out of band Noise fs=44.1kHz, fin=1kHz, No input
VP=12V, VD1=VD2=VVD1=VVD2=VVD3=VVD4=5V

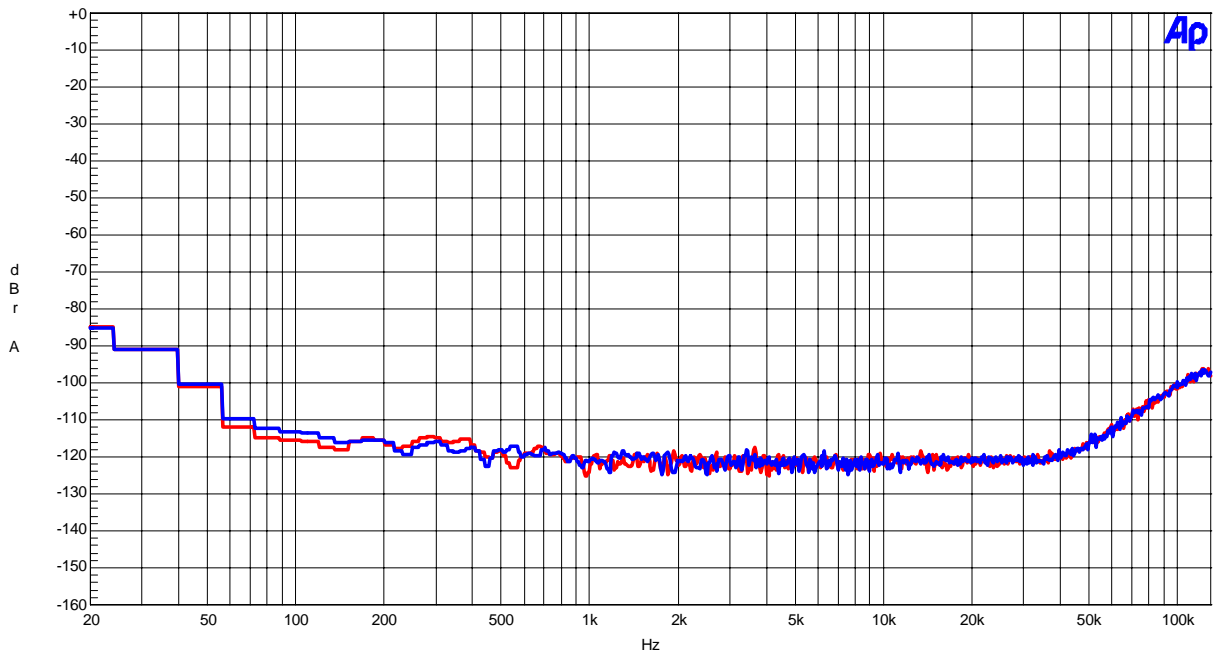

Figure1-4. FFT (Outband Noise)

AKM

AK4706 THD+N vs Input Level fs=44.1kHz, fin=1kHz
VP=12V, VD1=VD2=VVD1=VVD2=VVD3=VVD4=5V

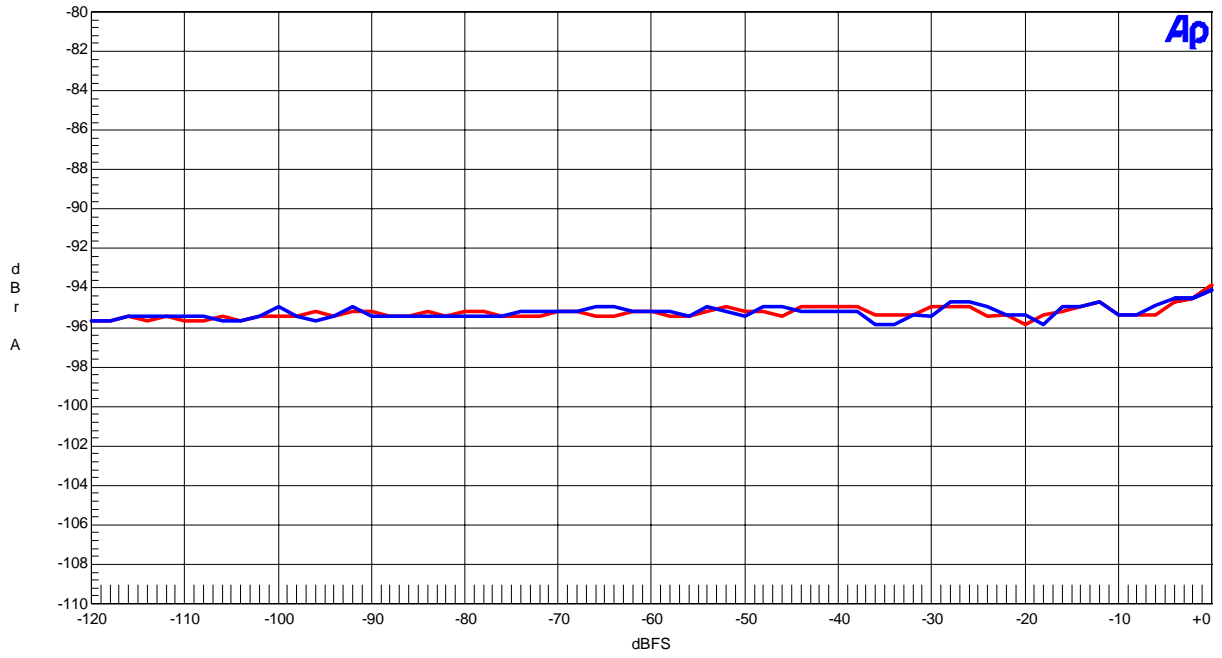

Figure1-5. THD+N vs. Input level (fin=1kHz)

AKM

AK4706 THD+N vs Input Frequency fs=44.1kHz, fin=1kHz
VP=12V, VD1=VD2=VVD1=VVD2=VVD3=VVD4=5V

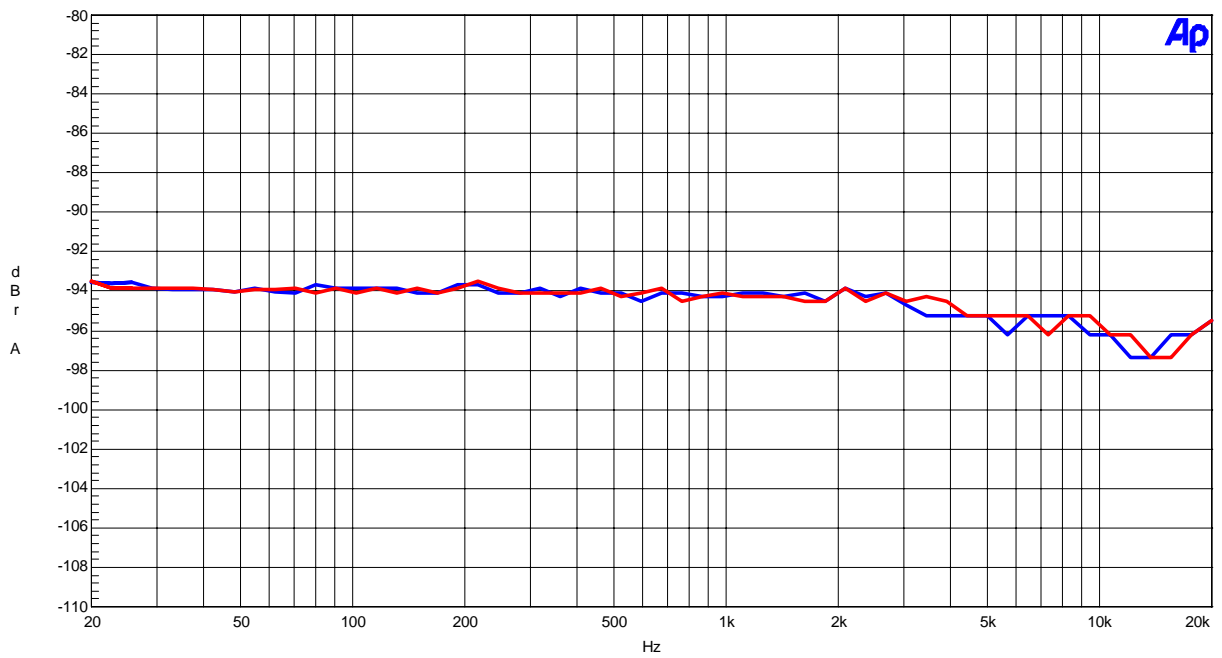

Figure1-6. THD+N vs. Input Frequency (Input level=0dBFS)

AKM

AK4706 Linearity fs=44.1kHz, fin=1kHz
VP=12V, VD1=VD2=VVD1=VVD2=VVD3=VVD4=5V

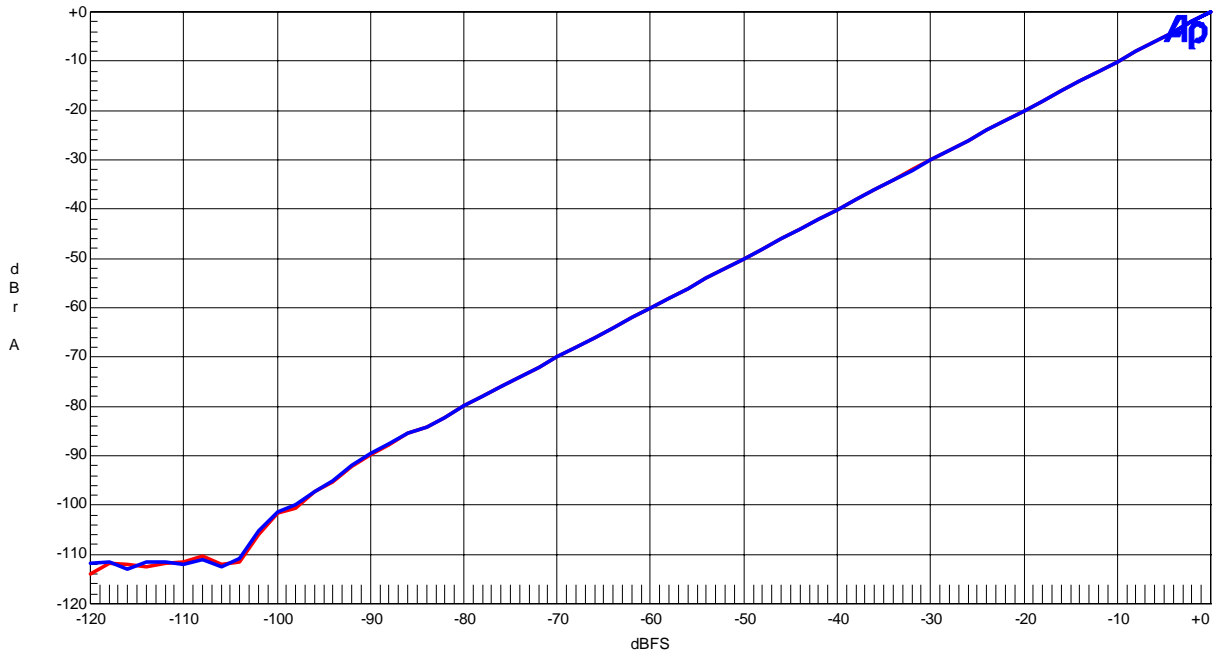

Figure1-7.Linearity (fin=1kHz)

AKM

AK4706 Frequency Respons fs=44.1kHz, fin=1kHz
VP=12V, VD1=VD2=VVD1=VVD2=VVD3=VVD4=5V

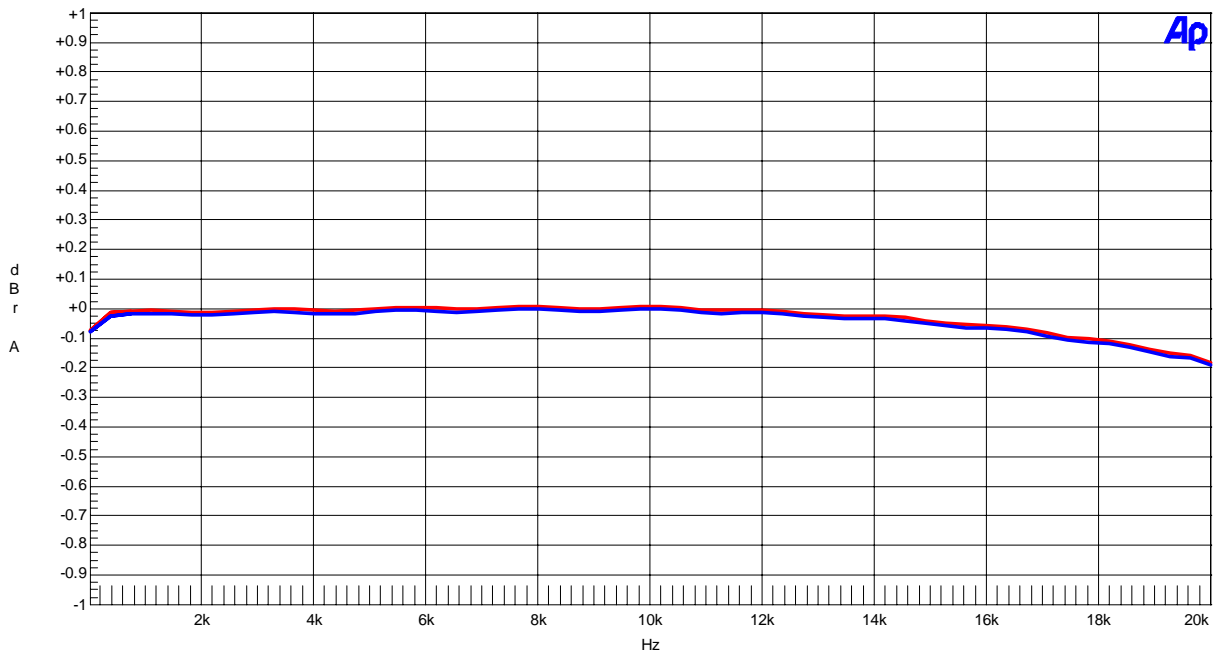

Figure1-8. Frequency Response (Input level=0dBFS)

AKM

AK4706 Crosstalk fs=44.1kHz, fin=1kHz
VP=12V, VD1=VD2=VVD1=VVD2=VVD3=VVD4=5V

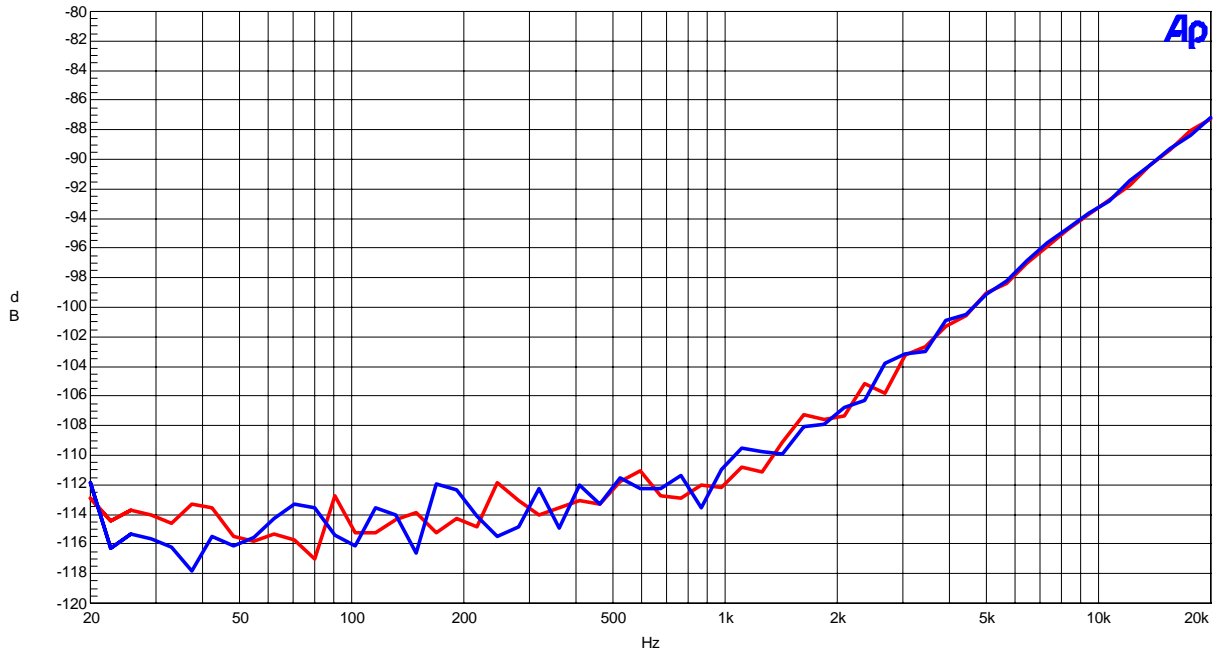

Figure1-9. Crosstalk (Input level=0dBFS)

Plots(Video)

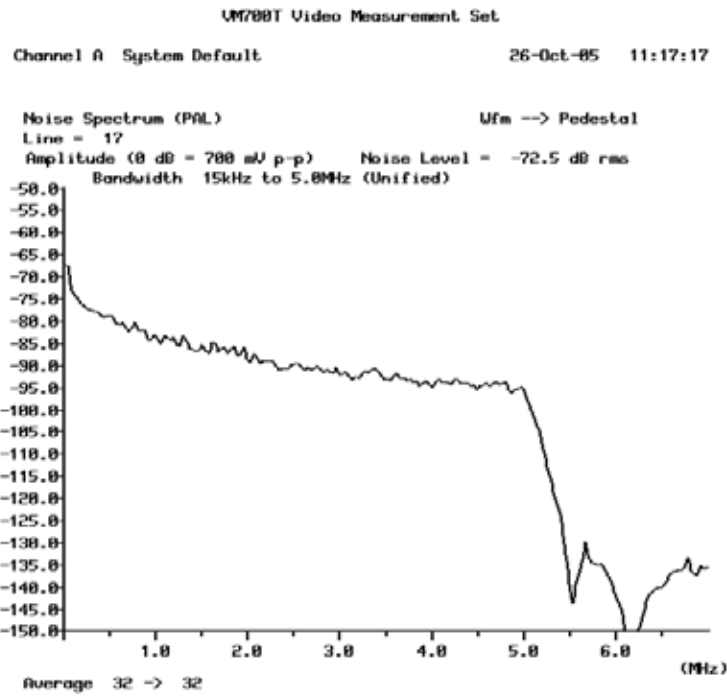

Figure 2-1. Noise spectrum (Input=0% flat field, BW=15kHz to 5MHz, Uni-weighted)

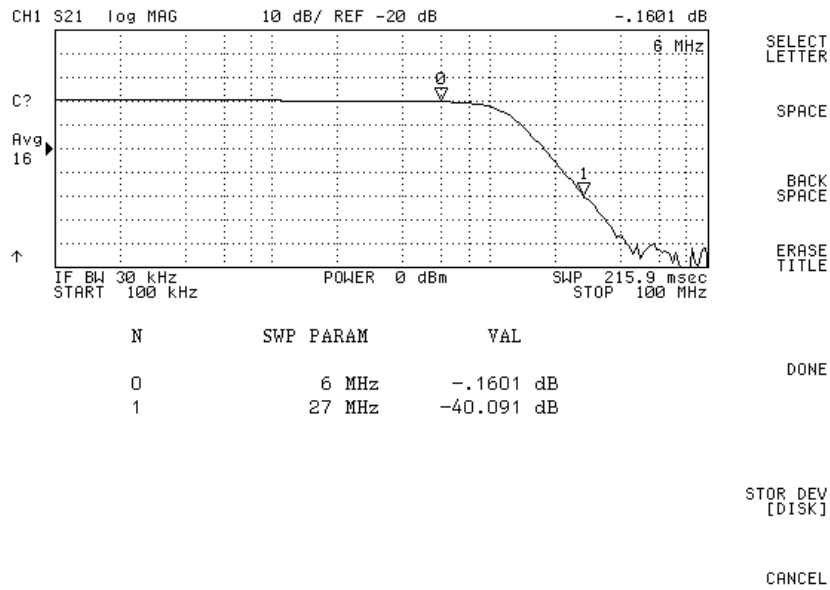

Figure 2-2. Frequency Response (SD LPF response=6MHz)

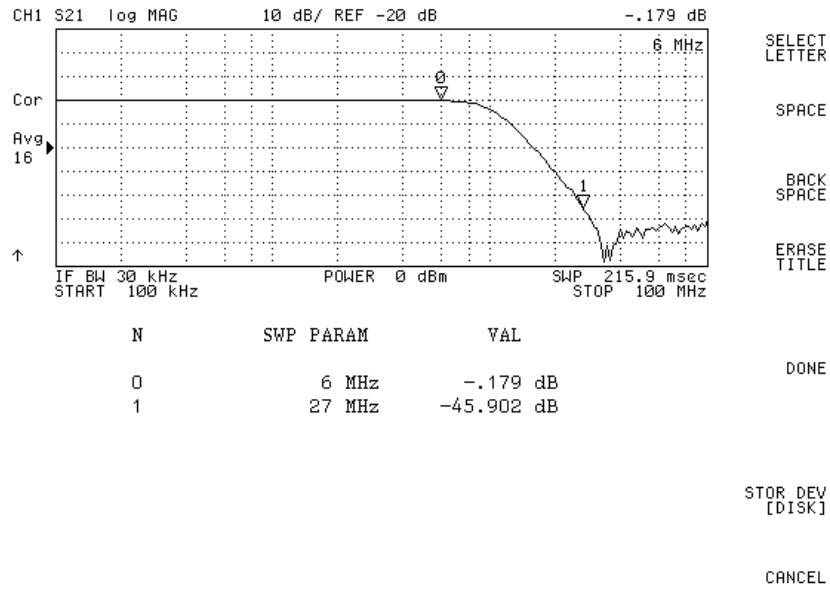

Figure 2-3. Frequency Response (HD LPF response=6MHz)

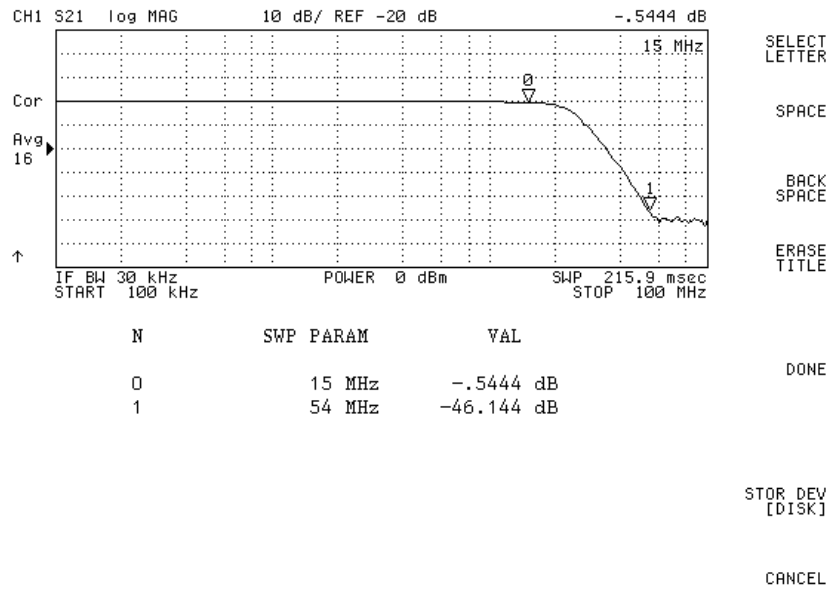

Figure 2-4. Frequency Response (HD LPF response=12MHz)

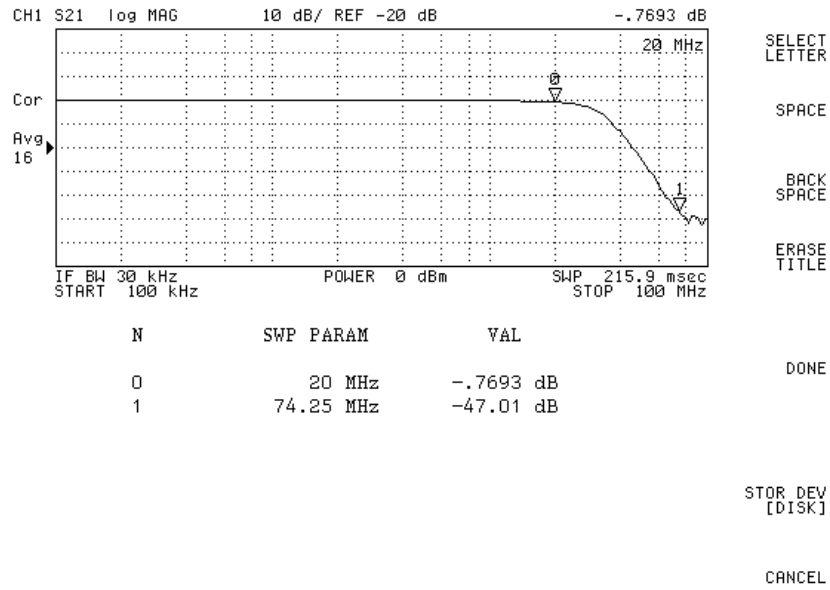

Figure 2-5. Frequency Response (HD LPF response=30MHz)

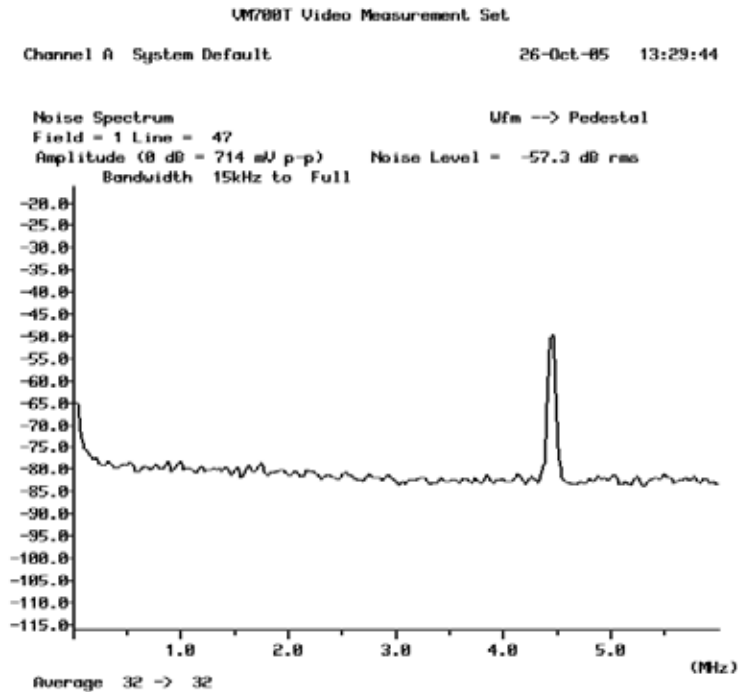

Figure 2-6. Crosstalk (Input= 100% red (ENCRC), measured at TVVOUT)

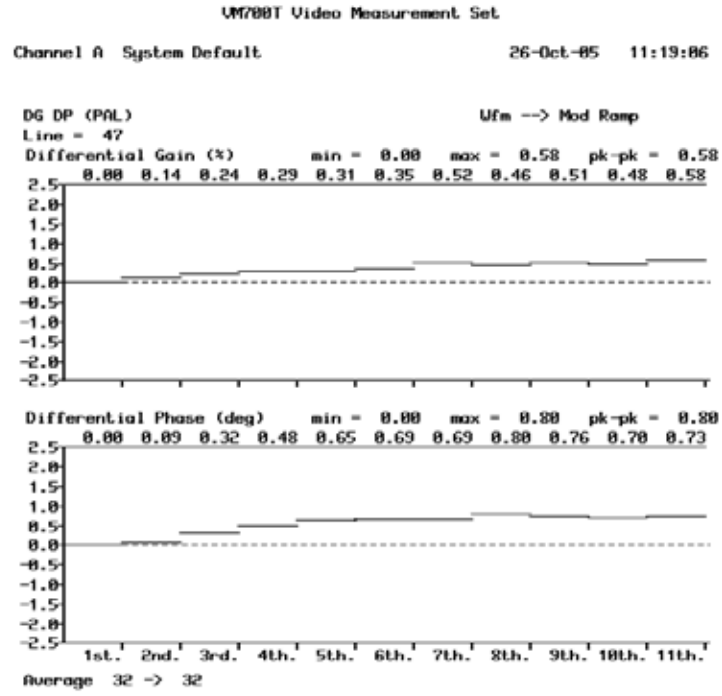

Figure 2-7. DG, DP (Input= Modulated Lamp)

Revision History

Date (YY/MM/DD)	Manual Revision	Board Revision	Reason	Contents
05/11/02	KM081400	0	First edition	
05/12/28	KM081401	1	Modification	Circuit diagram was changed (page 5/5). The R94 was changed from 300Ω to 75Ω.

IMPORTANT NOTICE

- These products and their specifications are subject to change without notice. Before considering any use or application, consult the Asahi Kasei Microsystems Co., Ltd. (AKM) sales office or authorized distributor concerning their current status.
- AKM assumes no liability for infringement of any patent, intellectual property, or other right in the application or use of any information contained herein.
- Any export of these products, or devices or systems containing them, may require an export license or other official approval under the law and regulations of the country of export pertaining to customs and tariffs, currency exchange, or strategic materials.
- AKM products are neither intended nor authorized for use as critical components in any safety, life support, or other hazard related device or system, and AKM assumes no responsibility relating to any such use, except with the express written consent of the Representative Director of AKM. As used here:
 - (a) A hazard related device or system is one designed or intended for life support or maintenance of safety or for applications in medicine, aerospace, nuclear energy, or other fields, in which its failure to function or perform may reasonably be expected to result in loss of life or in significant injury or damage to person or property.
 - (b) A critical component is one whose failure to function or perform may reasonably be expected to result, whether directly or indirectly, in the loss of the safety or effectiveness of the device or system containing it, and which must therefore meet very high standards of performance and reliability.
- It is the responsibility of the buyer or distributor of an AKM product who distributes, disposes of, or otherwise places the product with a third party to notify that party in advance of the above content and conditions, and the buyer or distributor agrees to assume any and all responsibility and liability for and hold AKM harmless from any and all claims arising from the use of said product in the absence of such notification.

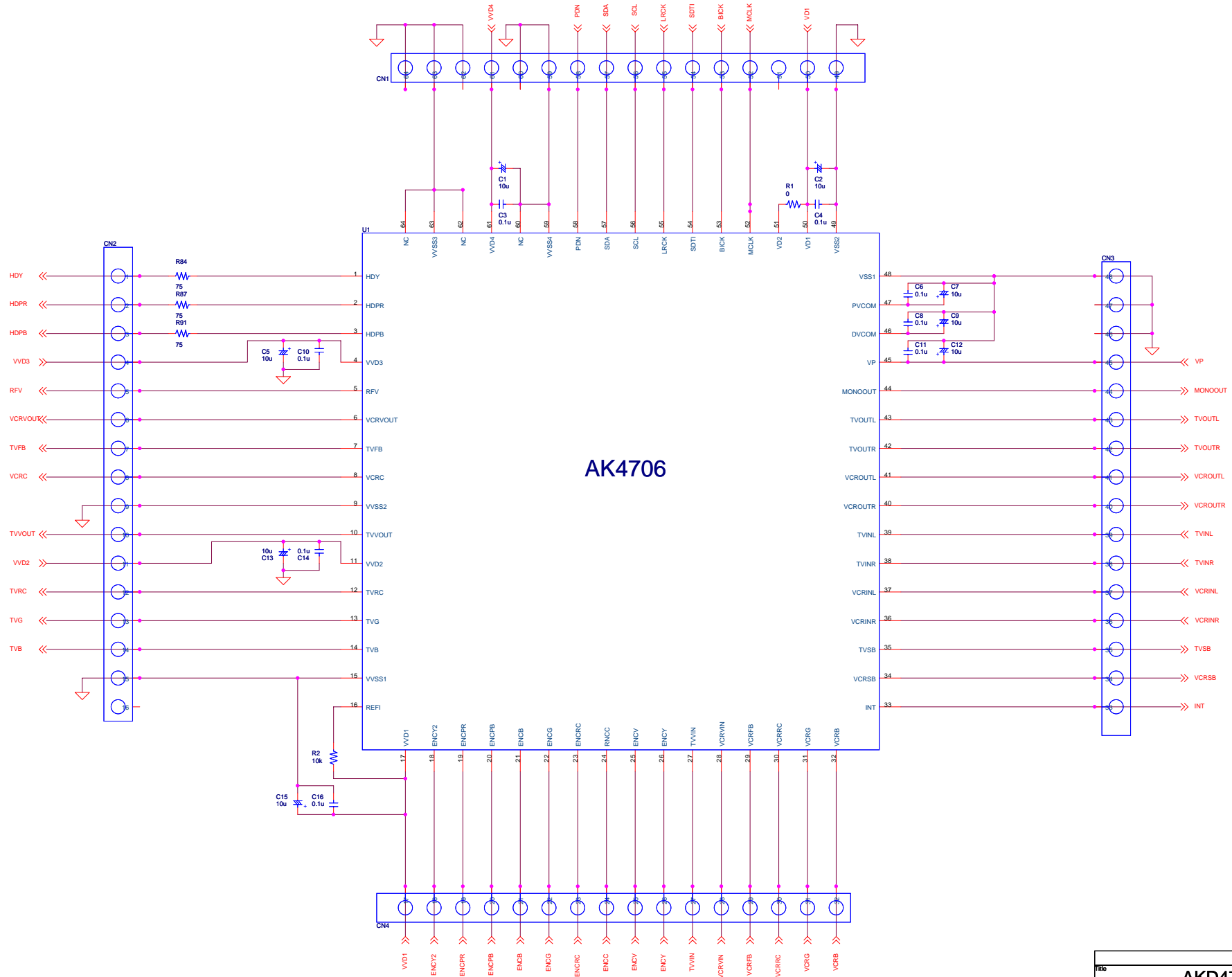

AK4706

Title	AKD4706-A	
Size	Document Number	Rev
C	AK4706	0
Date:	Monday, August 08, 2005	Sheet 1 of 5

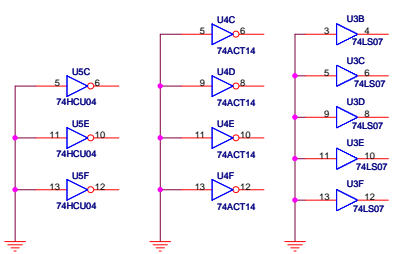
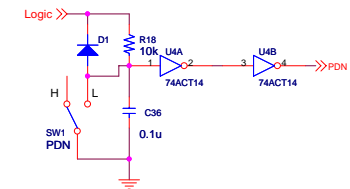
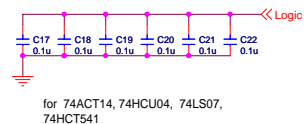
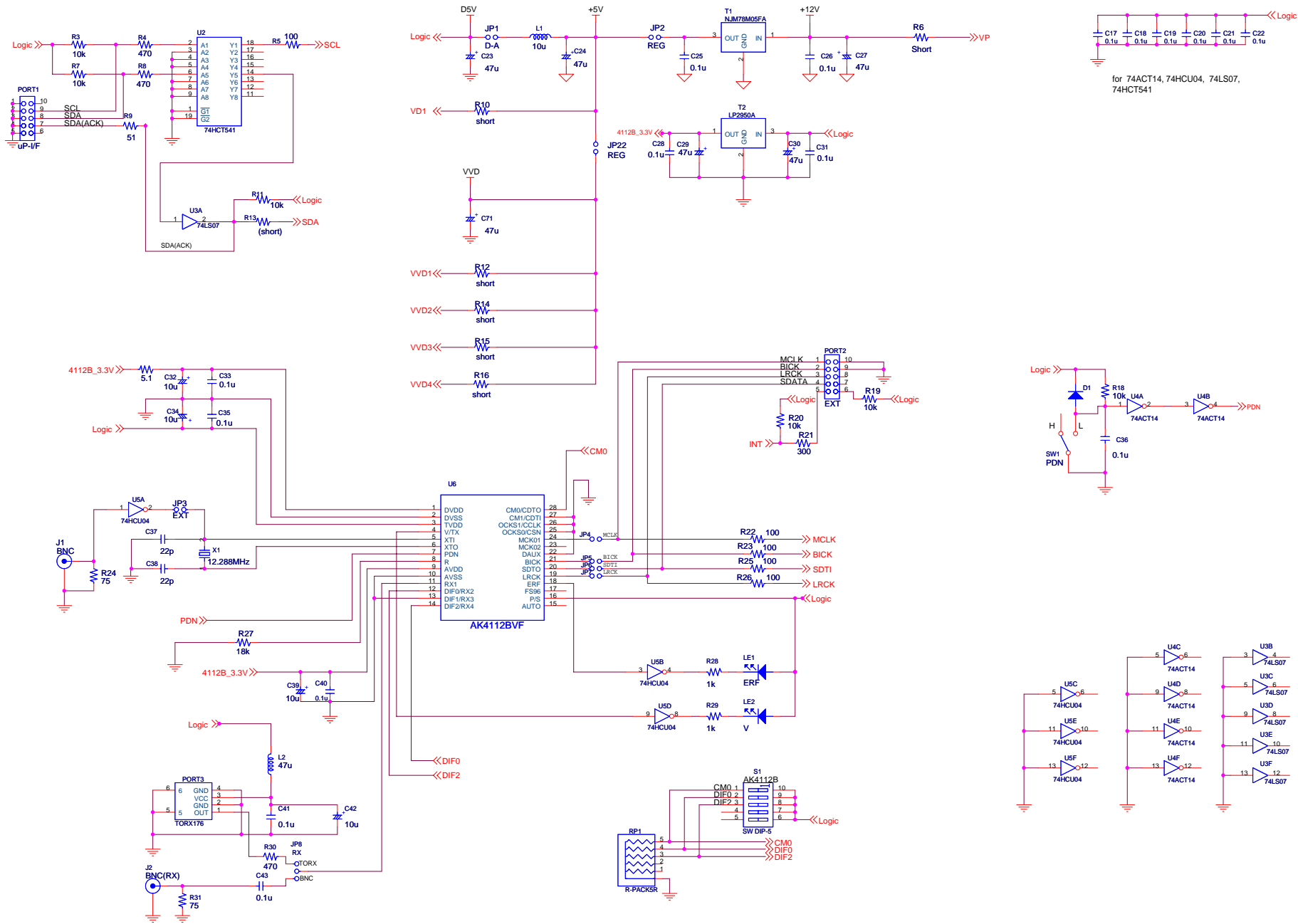

Title			AKD4706-A		
Size	Document Number				Rev
C	Power supply / AK4112B				0
Date:	Thursday, August 11, 2005	Sheet	2	of	5

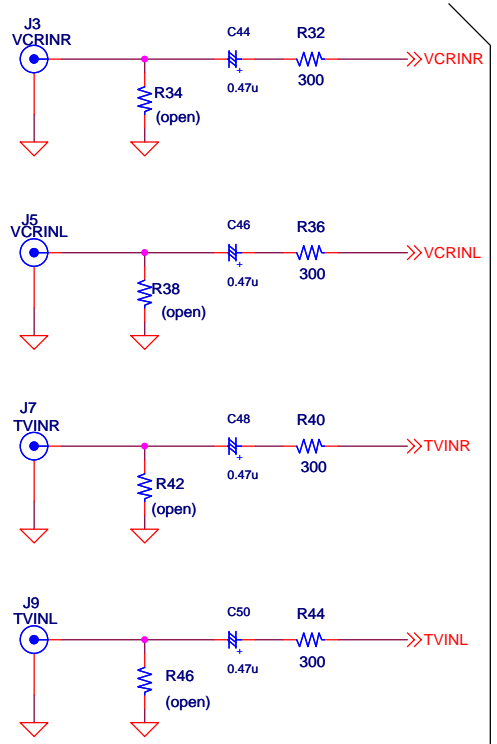

From Analog output

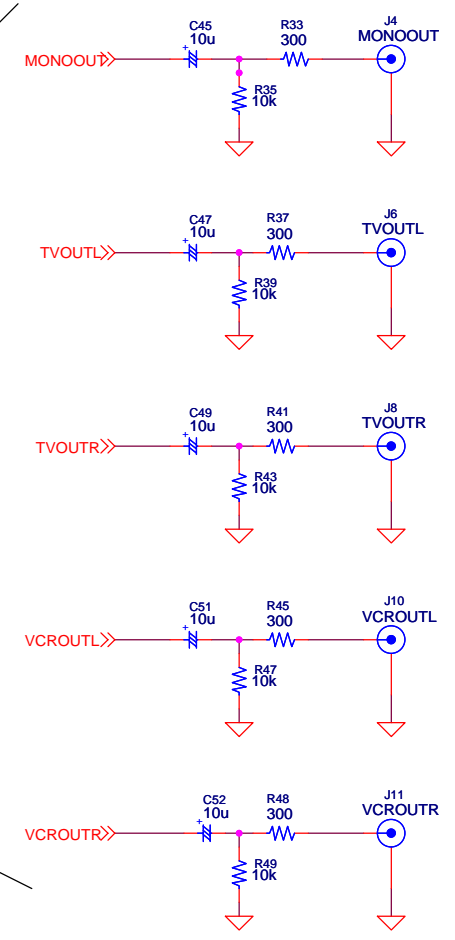

Title			AKD4706-A		
Size	Document Number				Rev
B	Analog Input/Output Circuit				0
Date:	Thursday, July 21, 2005	Sheet	3	of	5

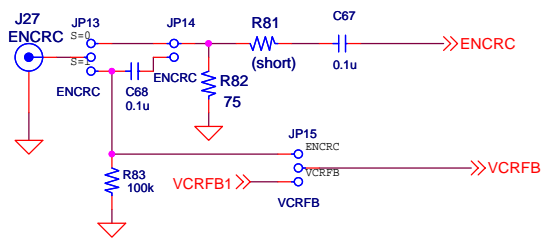
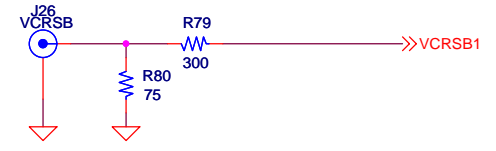
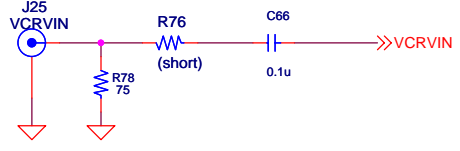
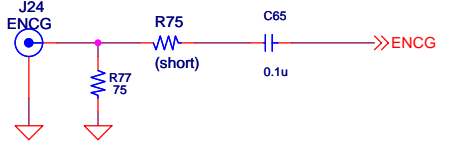
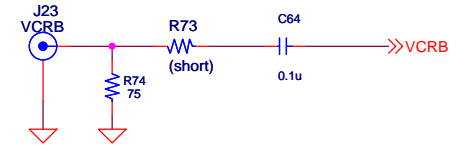
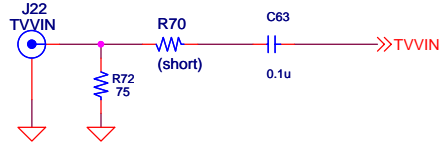
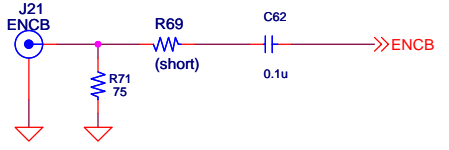
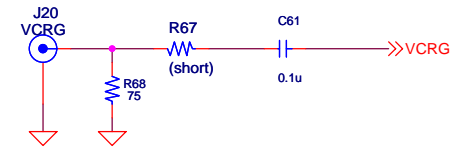
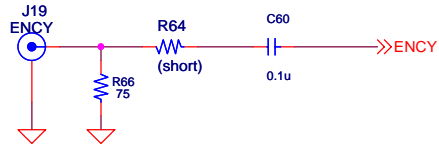
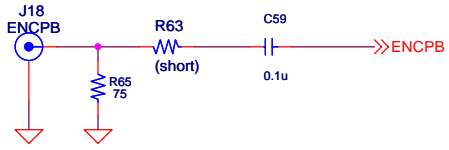
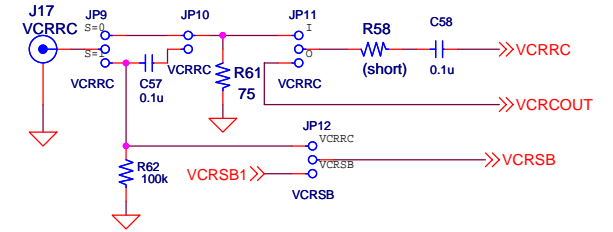
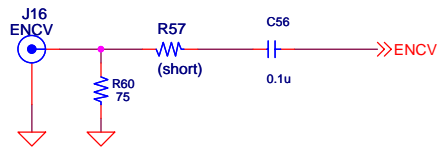
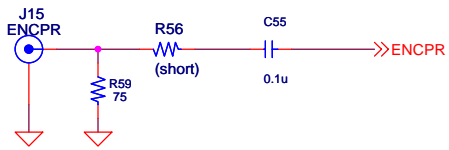
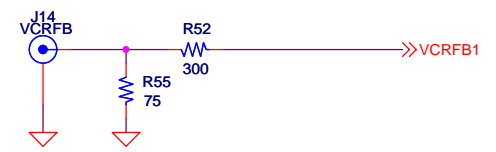
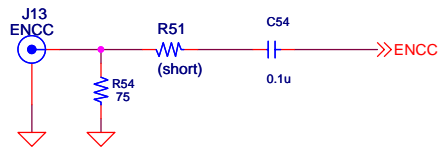
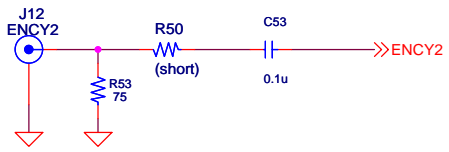

Title		
AKD4706-A		
Size	Document Number	Rev
B	Video Block Input Circuit	0
Date:	Friday, July 22, 2005	Sheet 4 of 5

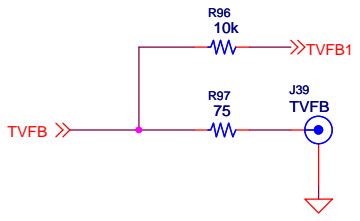
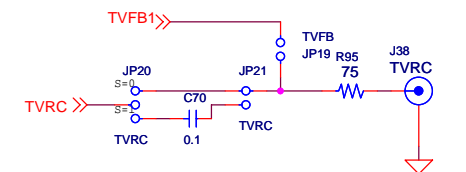
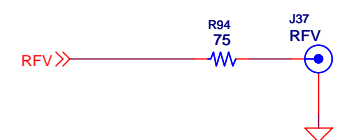
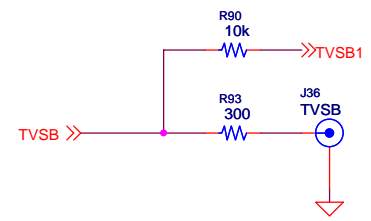
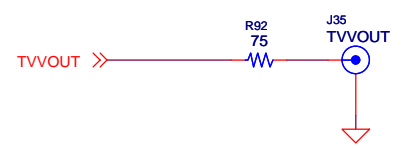
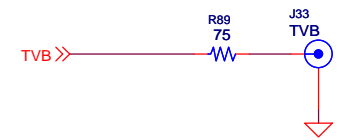
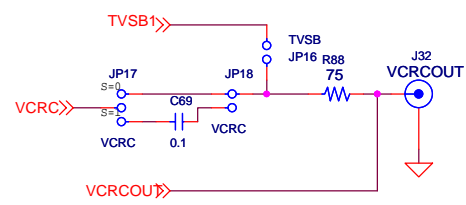
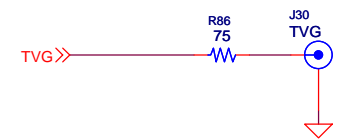
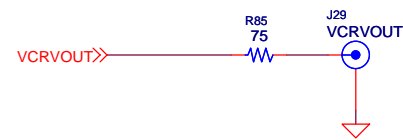

Title		
AKD4706-A		
Size B	Document Number Video Block Output Circuit	Rev 0
Date: Wednesday, December 28, 2005	Sheet 5	of 5

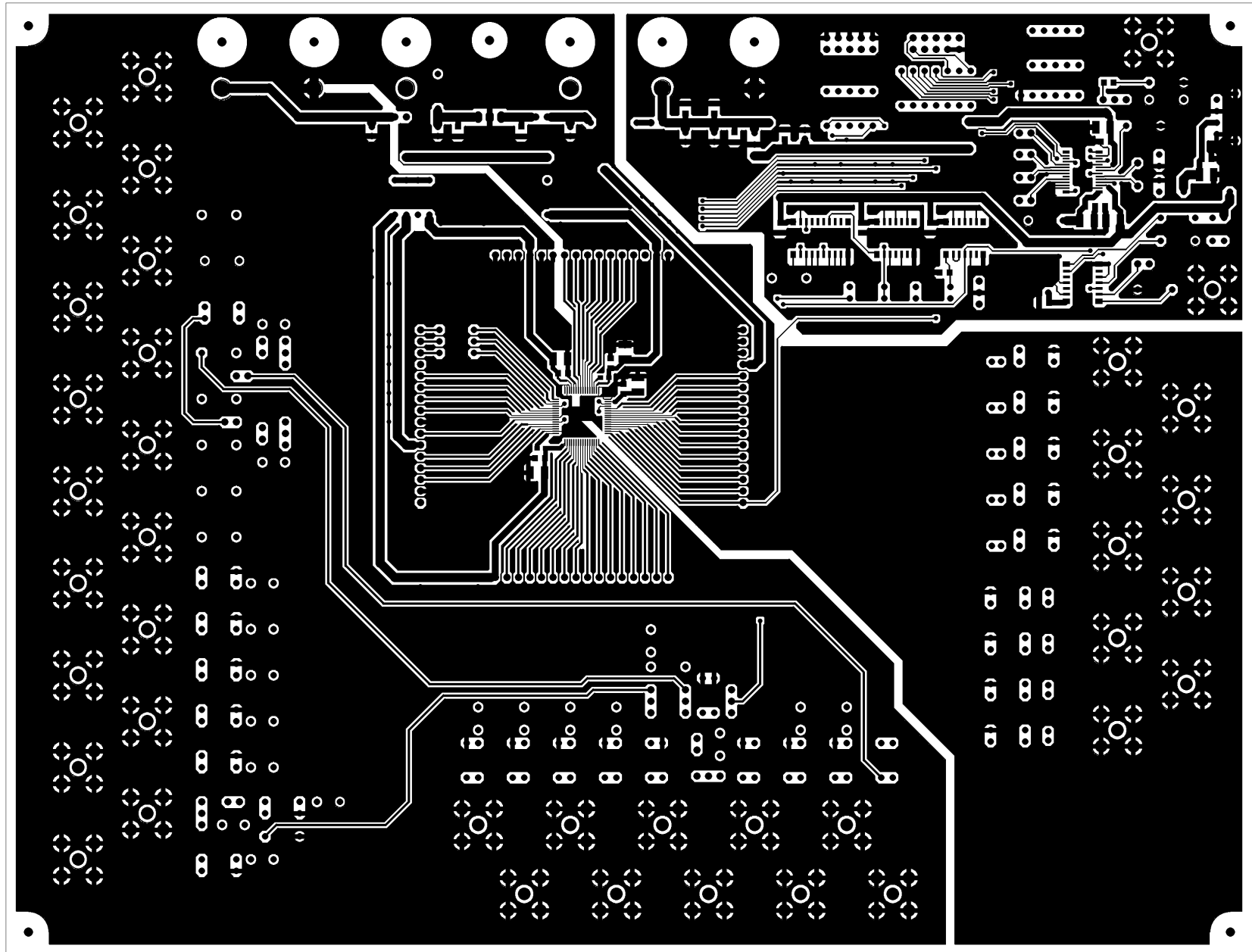

L1 PATTERN

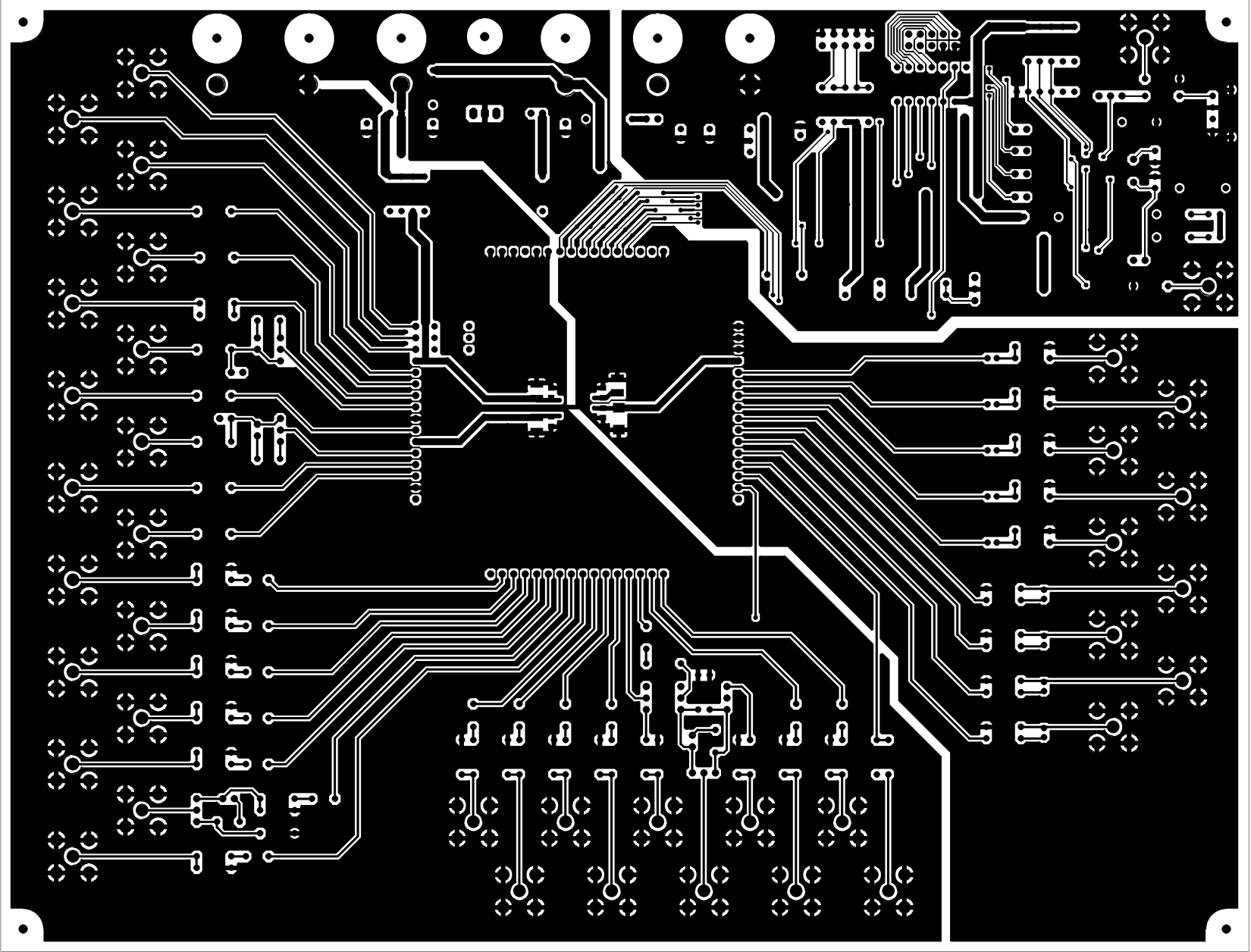

LS PATTERN

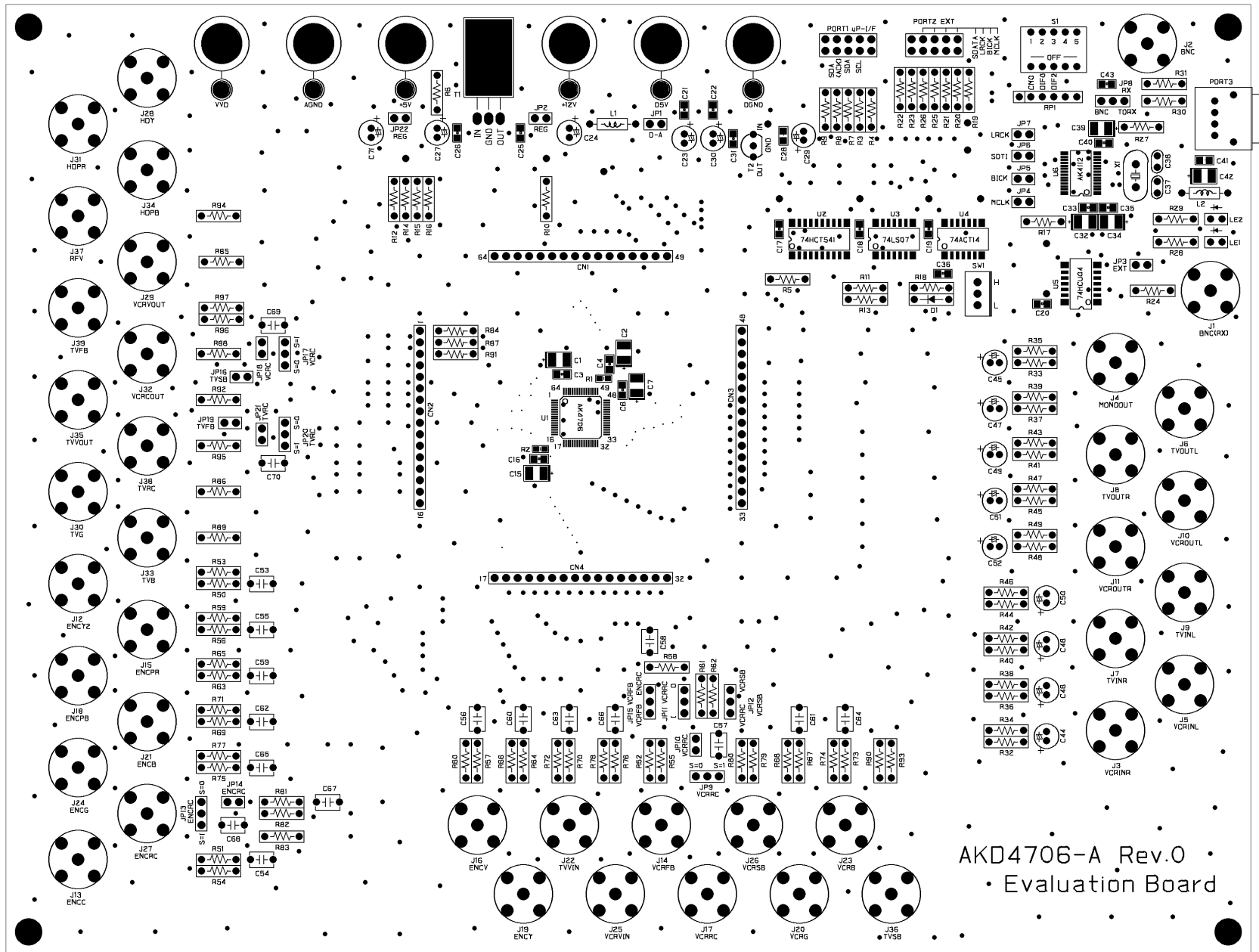

AKD4706-A Rev.0
 Evaluation Board

L1 S/R SILK

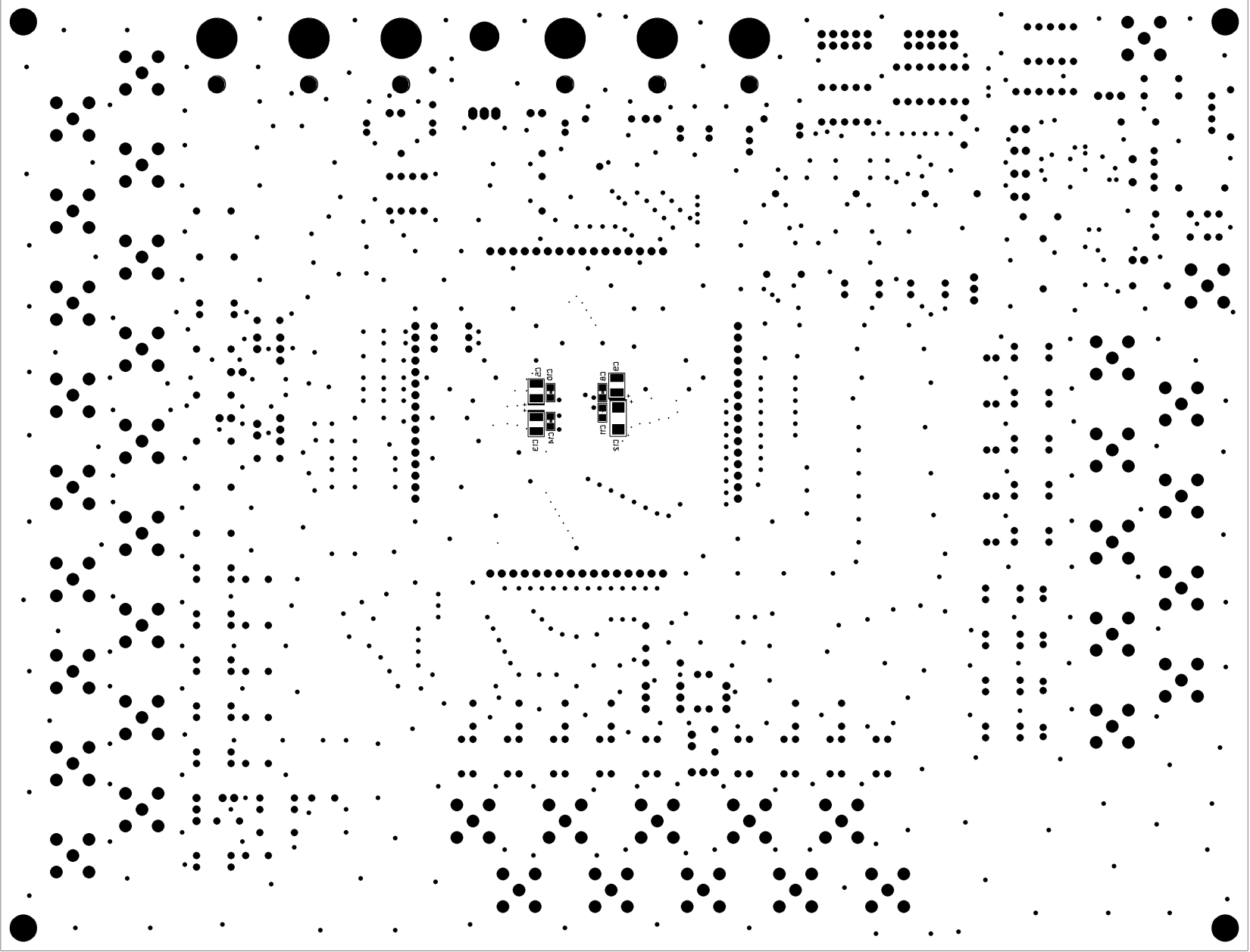

LS 2VR SILK