



50WQ03FNPbF

SCHOTTKY RECTIFIER

5.5 Amp

$$I_{F(AV)} = 5.5\text{Amp}$$

$$V_R = 30\text{V}$$

Major Ratings and Characteristics

| Characteristics | Values | Units |
|---|------------|------------------|
| $I_{F(AV)}$ Rectangular waveform | 5.5 | A |
| V_{RRM} | 30 | V |
| I_{FSM} @ $t_p = 5 \mu\text{s}$ sine | 320 | A |
| V_F @ 5Apk , $T_J = 125^\circ\text{C}$ | 0.35 | V |
| T_J range | -40 to 150 | $^\circ\text{C}$ |

Description/ Features

The 50WQ03FNPbF surface mount Schottky rectifier has been designed for applications requiring low forward drop and small foot prints on PC board. Typical applications are in disk drives, switching power supplies, converters, free-wheeling diodes, battery charging, and reverse battery protection.

- Popular D-PAK outline
- Small foot print, surface moutable
- Low forward voltage drop
- High frequency operation
- Guard ring for enhanced ruggedness and long term reliability
- Lead-Free ("PbF" suffix)

Case Styles



D-PAK (TO-252AA)

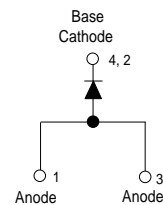

Voltage Ratings

| Part number | 50WQ03FNPbF |
|---|-------------|
| V_R Max. DC Reverse Voltage (V) | 30 |
| V_{RWM} Max. Working Peak Reverse Voltage (V) | |

Absolute Maximum Ratings

| Parameters | 50WQ... | Units | Conditions |
|---|---------|-------|--|
| $I_{F(AV)}$ Max. Average Forward Current * See Fig. 5 | 5.5 | A | 50% duty cycle @ $T_C = 136^\circ\text{C}$, rectangular wave form |
| I_{FSM} Max. Peak One Cycle Non-Repetitive Surge Current * See Fig. 7 | 320 | A | Following any rated load condition and with rated V_{RRM} applied |
| | 130 | | |
| E_{AS} Non-Repetitive Avalanche Energy | 10 | mJ | $T_J = 25^\circ\text{C}$, $I_{AS} = 2.0$ Amps, $L = 5$ mH |
| I_{AR} Repetitive Avalanche Current | 2.0 | A | Current decaying linearly to zero in 1 μsec Frequency limited by T_J max. $V_A = 1.5 \times V_R$ typical |

Electrical Specifications

| Parameters | 50WQ... | Units | Conditions |
|---|---------|------------|---|
| V_{FM} Max. Forward Voltage Drop * See Fig. 1 (1) | 0.46 | V | @ 5A $T_J = 25^\circ\text{C}$ |
| | 0.53 | V | @ 10A |
| | 0.35 | V | @ 5A $T_J = 125^\circ\text{C}$ |
| | 0.46 | V | @ 10A |
| I_{RM} Max. Reverse Leakage Current * See Fig. 2 (1) | 3 | mA | $T_J = 25^\circ\text{C}$ |
| | 58 | mA | $T_J = 125^\circ\text{C}$ $V_R = \text{rated } V_R$ |
| $V_{F(TO)}$ Threshold Voltage | 0.19 | V | $T_J = T_J \text{ max.}$ |
| r_t Forward Slope Resistance | 22.22 | m Ω | |
| C_T Typical Junction Capacitance | 590 | pF | $V_R = 5V_{DC}$ (test signal range 100Khz to 1Mhz) 25°C |
| L_S Typical Series Inductance | 5.0 | nH | Measured lead to lead 5mm from package body |

(1) Pulse Width < 300 μs , Duty Cycle < 2%

Thermal-Mechanical Specifications

| Parameters | 50W... | Units | Conditions |
|---|------------|--------------------|---------------------------|
| T_J Max. Junction Temperature Range (*) | -40 to 150 | $^\circ\text{C}$ | |
| T_{stg} Max. Storage Temperature Range | -40 to 150 | $^\circ\text{C}$ | |
| R_{thJC} Max. Thermal Resistance Junction to Case | 3.0 | $^\circ\text{C/W}$ | DC operation * See Fig. 4 |
| wt Approximate Weight | 0.3 (0.01) | g (oz.) | |
| Case Style | D-PAK | | Similar to TO-252AA |
| Marking Device | 50WQ03FN | | |

(*) $\frac{dP_{tot}}{dT_J} < \frac{1}{R_{th(j-a)}}$ thermal runaway condition for a diode on its own heatsink

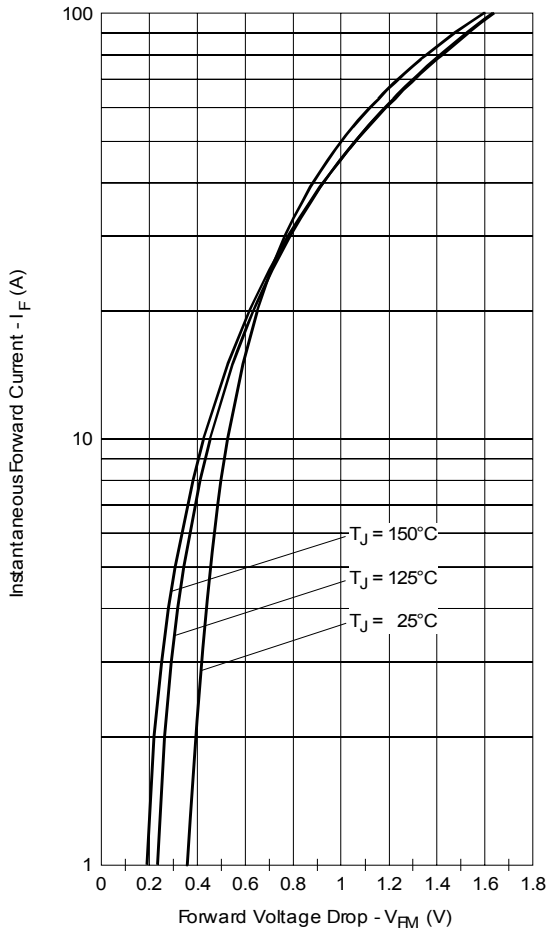

Fig. 1 - Maximum Forward Voltage Drop Characteristics

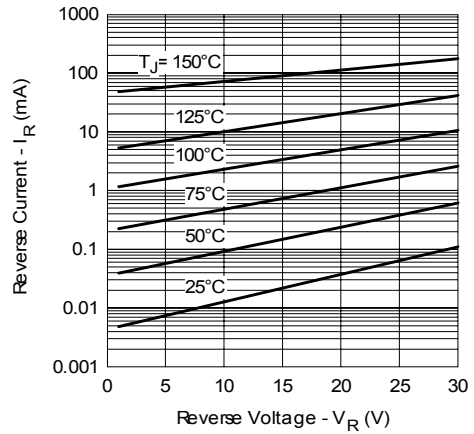

Fig. 2 - Typical Values of Reverse Current Vs. Reverse Voltage

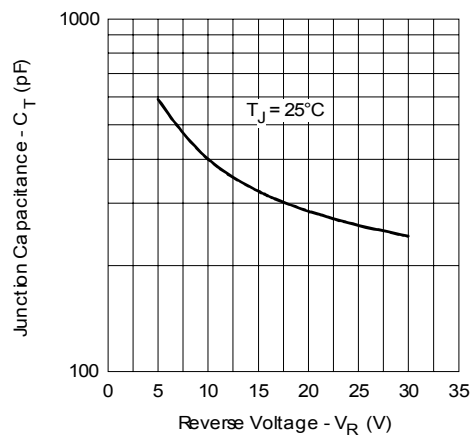

Fig. 3 - Typical Junction Capacitance Vs. Reverse Voltage

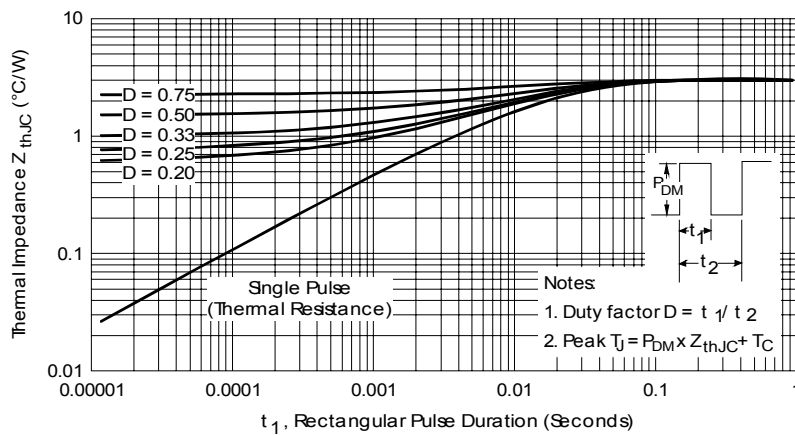

Fig. 4 - Maximum Thermal Impedance Z_{thJC} Characteristics

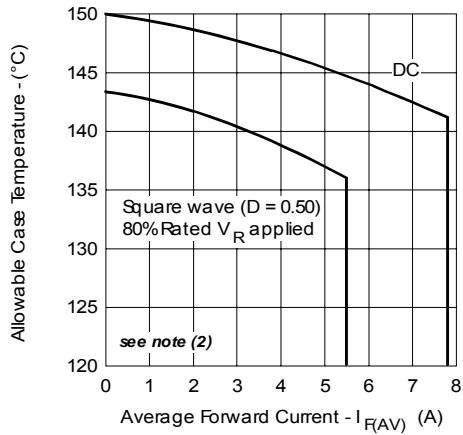

Fig. 5 - Maximum Allowable Case Temperature Vs. Average Forward Current

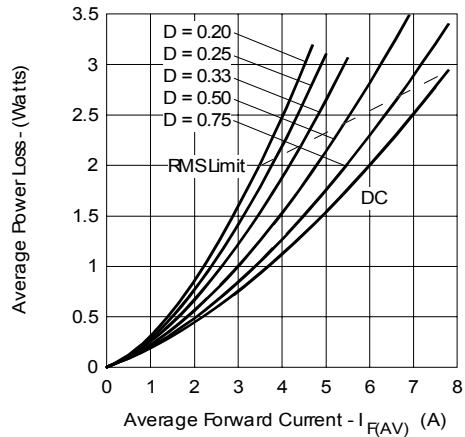

Fig. 6 - Forward Power Loss Characteristics

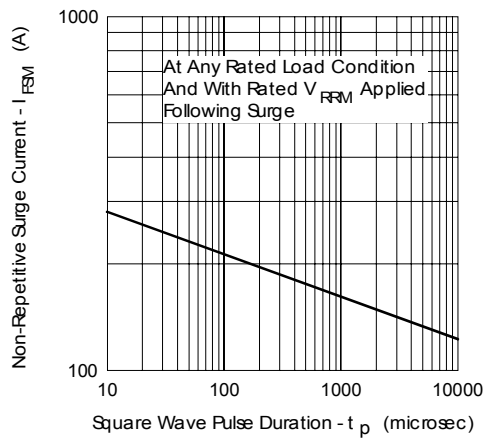

Fig. 7 - Maximum Non-Repetitive Surge Current

(2) Formula used: $T_c = T_j - (Pd + Pd_{REV}) \times R_{thJC}$;

Pd = Forward Power Loss = $I_{F(AV)} \times V_{FM} @ (I_{F(AV)} / D)$ (see Fig. 6);

Pd_{REV} = Inverse Power Loss = $V_{R1} \times I_R (1 - D)$; $I_R @ V_{R1} = 80\%$ rated V_R

Outline Table

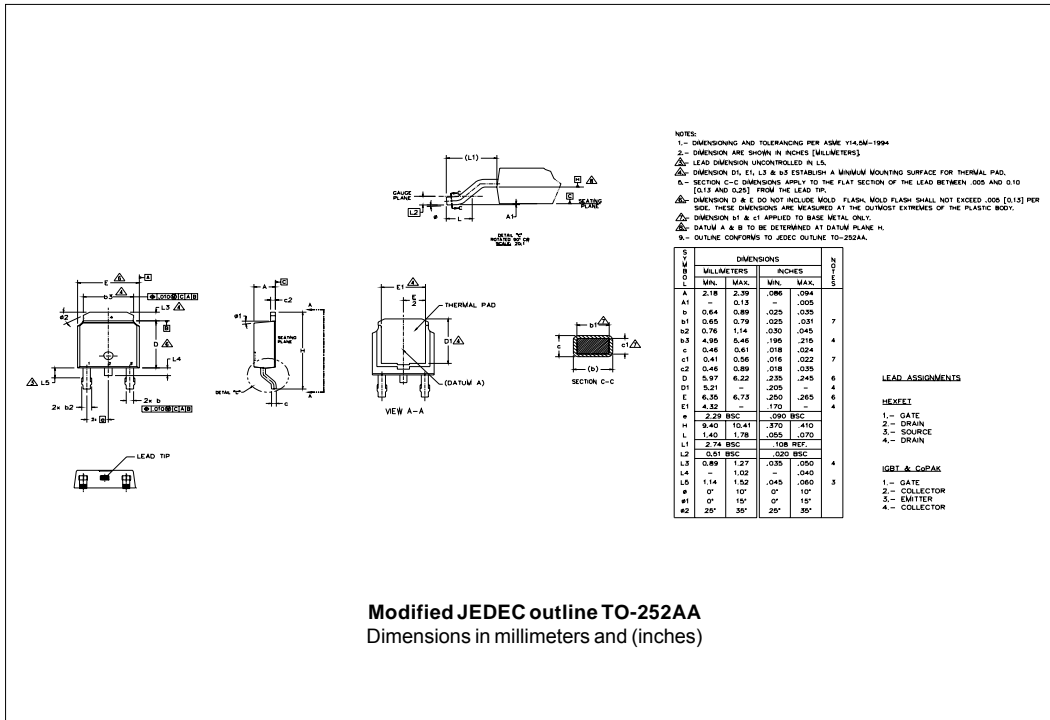

Part Marking Information

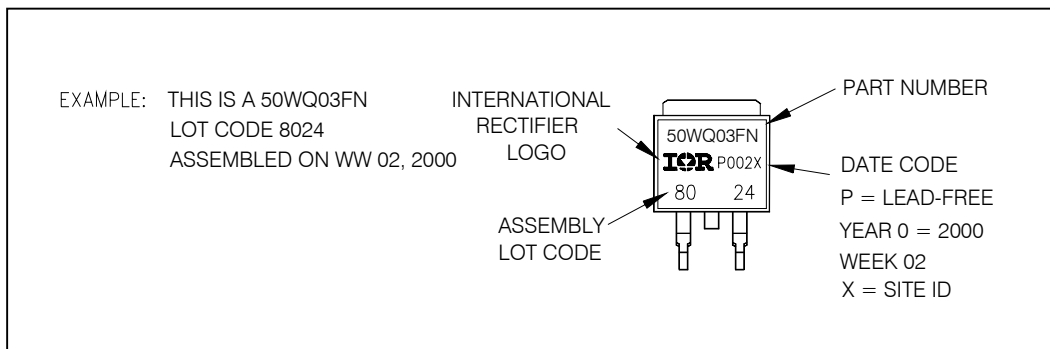

Tape & Reel Information

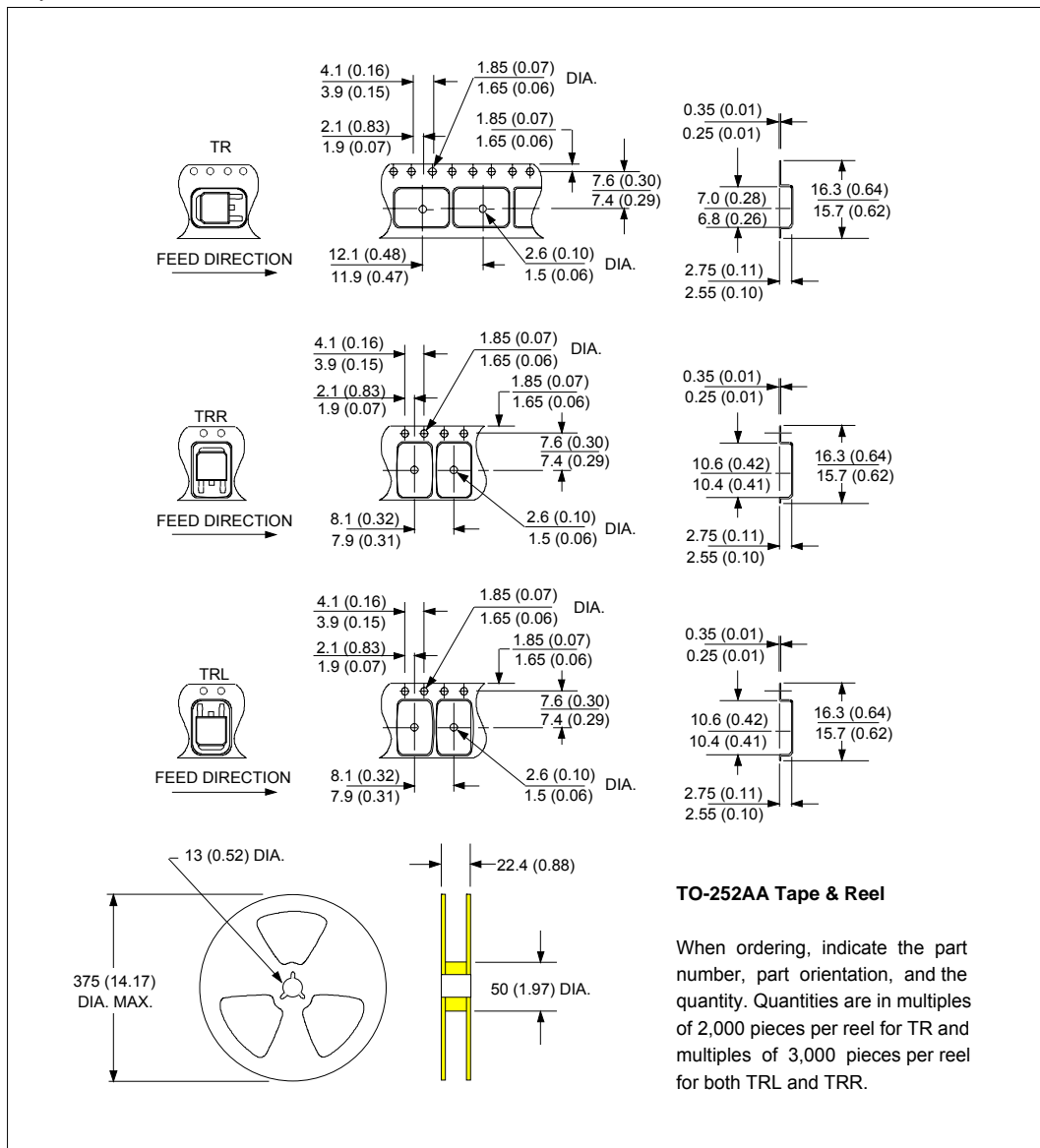

Ordering Information Table

| Device Code | |
|-------------|--|
| 50 | W |
| ① | ② |
| Q | 03 |
| ③ | ④ |
| FN | TRL |
| ⑤ | ⑥ |
| PbF | ⑦ |
| 1 | - Current Rating (5.5A) |
| 2 | - Package Identifier W = D-Pak |
| 3 | - Schottky "Q" Series |
| 4 | - Voltage Rating (03 = 30V) |
| 5 | - FN = TO-252AA (D-Pak) |
| 6 | - • none = Tube (50 pieces) • TR = Tape & Reel • TRL = Tape & Reel (Left Oriented) • TRR = Tape & Reel (Right Oriented) |
| 7 | - • none = Standard Production • PbF = Lead-Free |

Data and specifications subject to change without notice.
 This product has been designed and qualified for AEC Q101 Level and Lead-Free.
 Qualification Standards can be found on IR's Web site.