

ZXCT1080

High voltage high-side current monitor

Description

The ZXCT1080 is a high side current sense monitor with a gain of 10 and a voltage output. Using this device eliminates the need to disrupt the ground plane when sensing a load current.

The wide input voltage range of 60V down to as low as 3V make it suitable for a range of applications; including systems operating from industrial 24-28V rails and -48V rails.

The separate supply pin (V_{CC}) allows the device to continue functioning under short circuit conditions, giving an end stop voltage at the output.

The ZXCT1080 has an extended ambient operating temperature range of -40°C to 125°C enabling it to be used in a wide range of applications including automotive.

Features

- 3V to 60V continuous high side voltage
- Accurate high-side current sensing
- -40 to 125°C temperature range
- Output voltage scaling $\times 10$
- 4.5V to 12V V_{CC} range
- Low quiescent current:
 - $70\mu\text{A}$ supply pin
 - $50\mu\text{A}$ I_{SENSE+}
- SOT23-5 package

Applications

- Industrial applications current measurement
- Battery management
- Over current monitor
- Power management
- Automotive current measurement

Pin connections

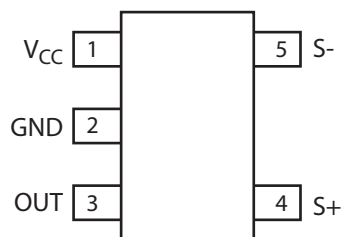

Typical application circuit

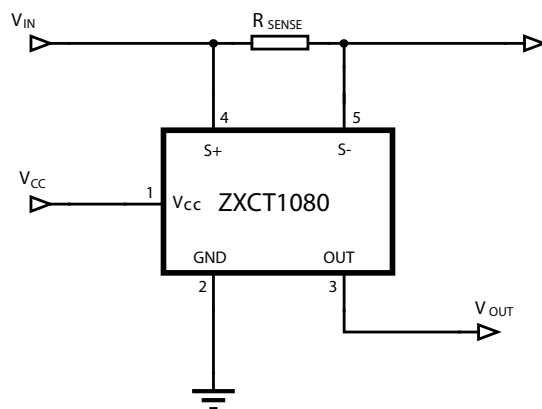

Ordering information

Device	Package	Part mark	Reel size (inches)	Tape width (mm)	Quantity per reel
ZXCT1080E5TA	SOT23-5	1080	7	8	3000

Absolute maximum ratings

Continuous voltage on S- and S+	-0.6 and 65V
Voltage on all other pins	-0.6V and +14V
Differential sense voltage, V_{SENSE}	800mV
Operating temperature	-40 to 125°C
Storage temperature	-55 to 150°C
Maximum junction temperature	125°C
Package power dissipation	300mW* at $T_A = 25^\circ\text{C}$

Operation above the absolute maximum rating may cause device failure. Operation at the absolute maximum ratings, for extended periods, may reduce device reliability.

V_{SENSE} is defined as the differential voltage between S+ and S- pins.

* Assumes $\Theta_{JA} = 420^\circ\text{C/W}$

Recommended operating conditions

Parameter		Min.	Max.	Units
V_{IN}	Common-mode sense+ input range	3	60	V
V_{CC}	Supply voltage range	4.5	12	V
V_{SENSE}	Differential sense input voltage range	0	0.15	V
V_{OUT}	Output voltage range	0	1.5	V
T_A	Ambient temperature range	-40	125	°C

Pin function table

Pin	Name	Description
1	V_{CC}	This is the analogue supply and provides power to internal circuitry
2	GND	Ground pin
3	OUT	Output voltage pin. NMOS source follower with 20µA bias to ground
4	S+	This is the positive input of the current monitor and has an input range from 60V down to 3V. The current through this pin varies with differential sense voltage
5	S-	This is the negative input of the current monitor and has an input range from 60V down to 3V

Electrical characteristics

Test conditions $T_A = 25^\circ\text{C}$, $V_{IN} = 12\text{V}$, $V_{CC} = 5\text{V}$, $V_{SENSE}^{(a)} = 100\text{mV}$ unless otherwise stated.

Symbol	Parameter	Conditions	T_A	Min ^(e)	Typ.	Max ^(e)	Units
I_{CC}	V_{CC} supply current	$V_{CC} = 12\text{V}$, $V_{SENSE}^{(a)} = 0\text{V}$	25°C	40	80	120	μA
			full range			145	
I_{S+}	S+ input current	$V_{SENSE}^{(a)} = 0\text{V}$	25°C	15	27	42	μA
			full range			60	
I_{S-}	S- input current	$V_{SENSE}^{(a)} = 0\text{V}$	25°C	15	40	80	nA
$V_{O(0)}$	Zero $V_{SENSE}^{(a)}$ error ^(b)		25°C	0		35	mV
$V_{O(10)}$	Output offset voltage ^(c)	$V_{SENSE}^{(a)} = 10\text{mV}$	25°C	-25		+25	mV
			full range	-55		+55	
Gain	$\Delta V_{OUT}/\Delta V_{SENSE}^{(a)}$	$V_{SENSE}^{(a)} = 10\text{mV}$ to 150mV	25°C	9.9	10	10.1	V/V
			full range	9.8		10.2	
$V_{OUT\ TC}^{(d)}$	V_{OUT} variation with temperature				30		ppm/°C
Acc	Total output error			-3		3	%
I_{OH}	Output source current	$\Delta V_{OUT} = -30\text{mV}$			1		mA
I_{OL}	Output sink current	$\Delta V_{OUT} = +30\text{mV}$			20		μA
PSRR	V_{CC} supply rejection ratio	$V_{CC} = 4.5\text{V}$ to 12V		54	60		dB
CMRR	Common-mode sense rejection ratio	$V_{IN} = 60\text{V}$ to 3V		68	80		dB
BW	-3dB small signal bandwidth	$V_{SENSE}^{(a)} (AC) = 10\text{mV}_{PP}$			500		kHz

NOTES:

(a) $V_{SENSE} = "V_{SENSE+}" - "V_{SENSE-}"$

(b) The ZXCT1080 operates from a positive power rail and the internal voltage-current converter current flow is unidirectional; these result in the output offset voltage for $V_{SENSE} = 0\text{V}$ always being positive.

(c) For $V_{SENSE} > 10\text{mV}$, the internal voltage-current converter is fully linear. This enables a true offset to be defined and used. $V_{O(10)}$ is expressed as the variance about an output voltage of 100mV.

(d) Temperature dependent measurements are extracted from characterization and simulation results.

(e) All Min and Max specifications over full temperature range are guaranteed by design and characterisation

Typical characteristics

Test conditions unless otherwise stated: $T_A = 25^\circ\text{C}$, $V_{CC} = 5\text{V}$, $V_{S+} = 12\text{V}$, $V_{SENSE} = 100\text{mV}$

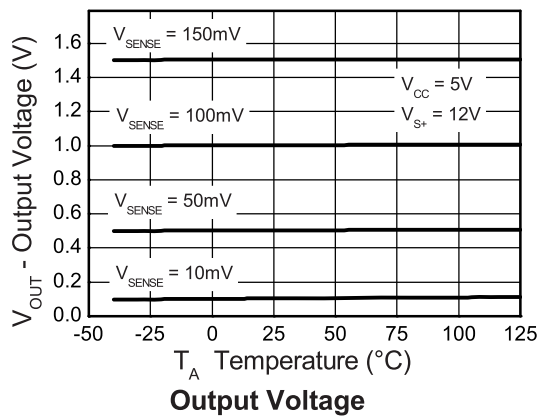
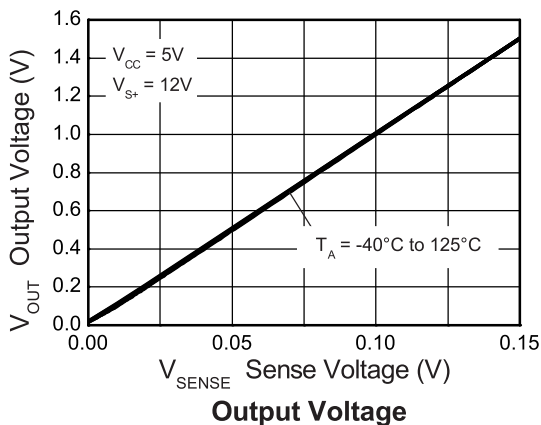
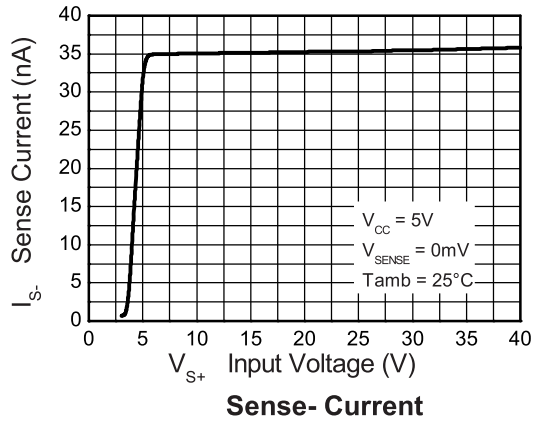
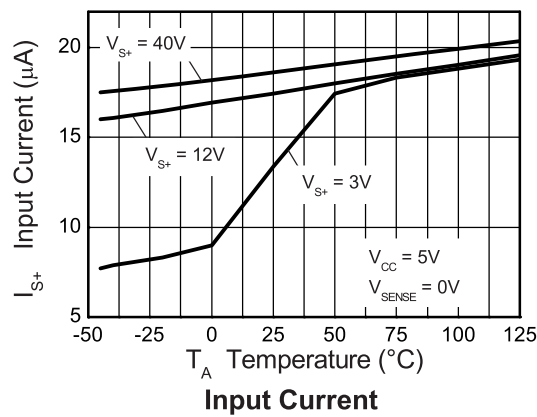
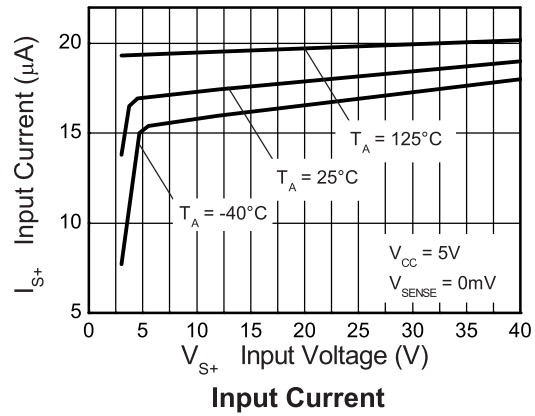
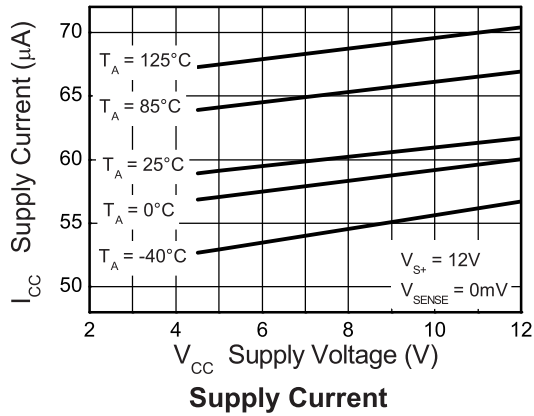

Typical characteristics

Test conditions unless otherwise stated: $T_A = 25^\circ\text{C}$, $V_{CC} = 5\text{V}$, $V_{SENSE+} = 12\text{V}$, $V_{SENSE} = 100\text{mV}$

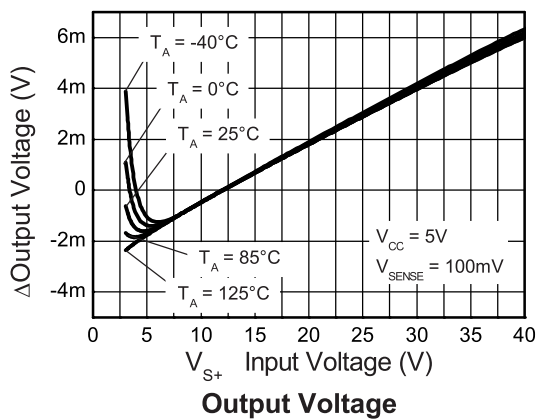
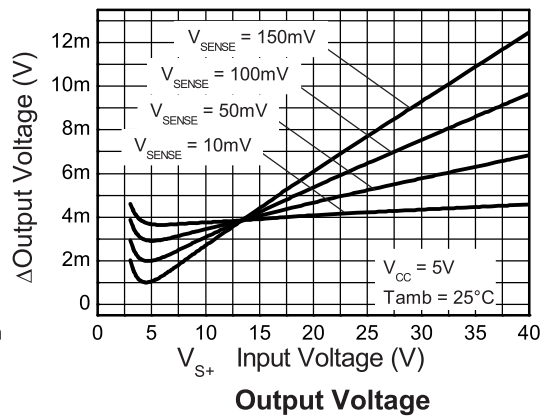
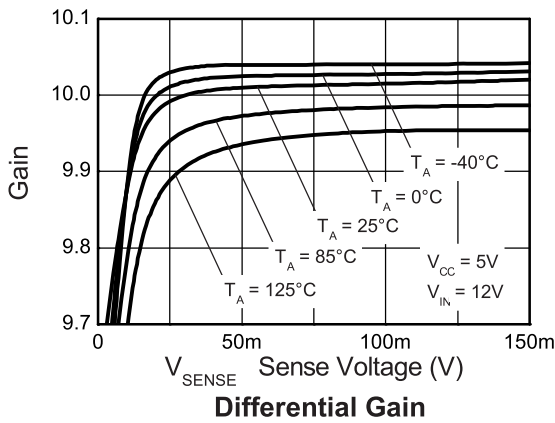
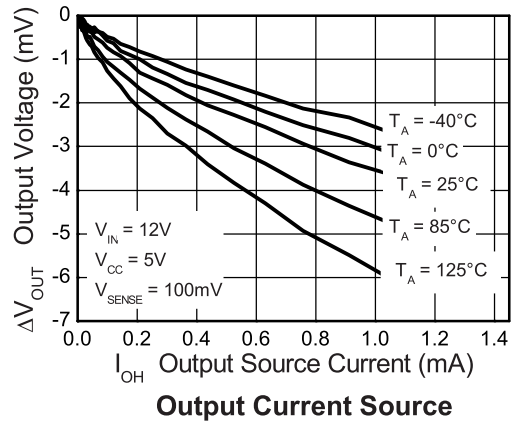
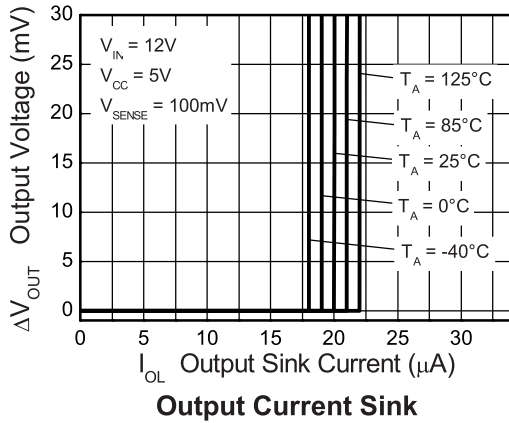

Typical characteristics

Test conditions unless otherwise stated: $T_A = 25^\circ\text{C}$, $V_{CC} = 5\text{V}$, $V_{SENSE+} = 12\text{V}$, $V_{SENSE} = 100\text{mV}$

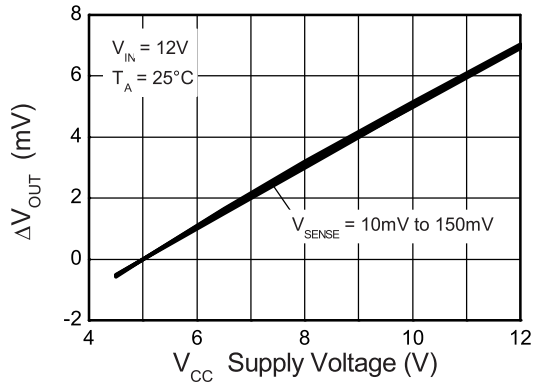

Normalised Output Voltage

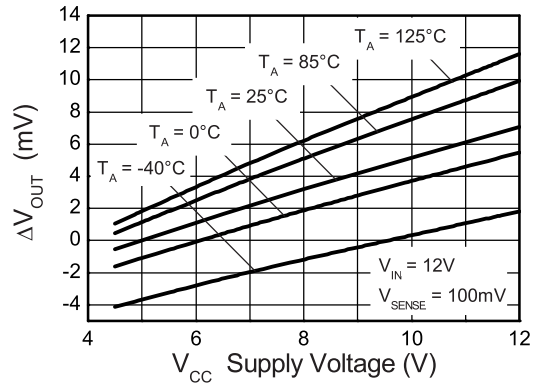

Normalised Output Voltage

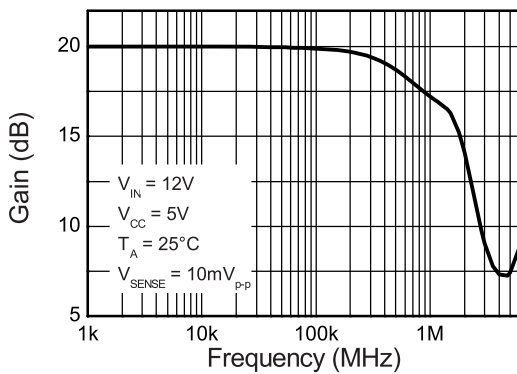

Small Signal Bandwidth

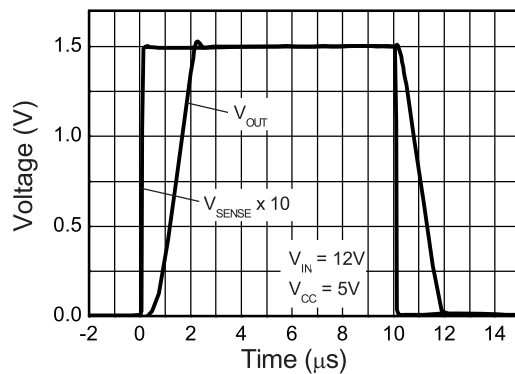

Large Signal Pulse Response

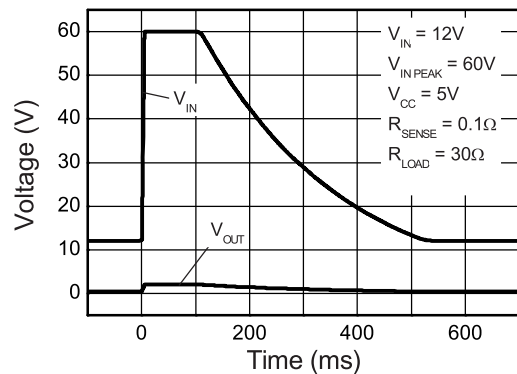

Load Dump Waveform

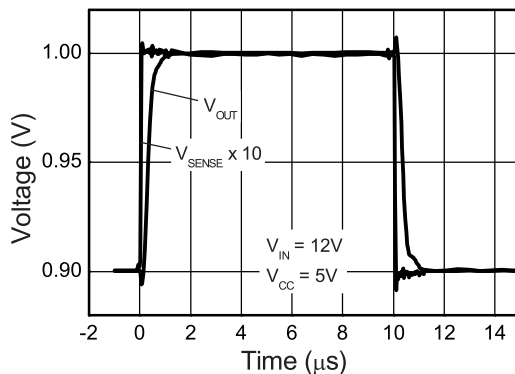

Small Signal Pulse Response

Typical characteristics

Test conditions unless otherwise stated: $T_A = 25^\circ\text{C}$, $V_{CC} = 5\text{V}$, $V_{\text{SENSE}+} = 12\text{V}$, $V_{\text{SENSE}} = 100\text{mV}$

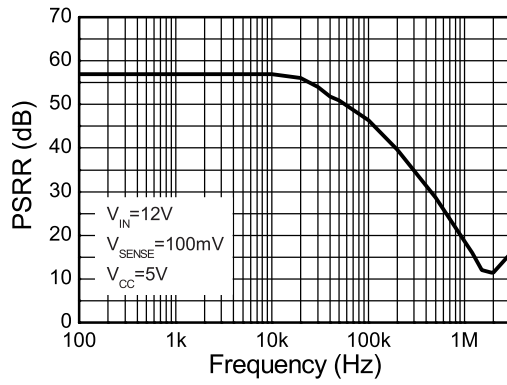

Supply Rejection

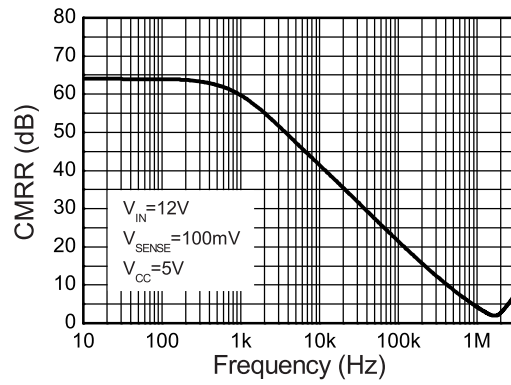

Common Mode Rejection

Application information

The ZXCT1080 has been designed to allow it to operate with 5V supply rails while sensing common mode signals up to 60V. This makes it well suited to a wide range of industrial and power supply monitoring applications that require the interface to 5V systems while sensing much higher voltages.

To allow this its V_{CC} pin can be used independently of $S+$.

Figure 1 shows the basic configuration of the ZXCT1080.

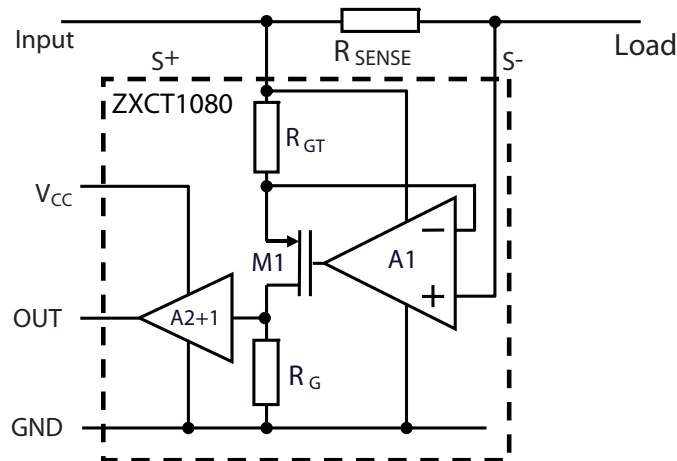

Figure 1 Typical configuration of ZXCT1080

Load current from the input is drawn through R_{SENSE} developing a voltage V_{SENSE} across the inputs of the ZXCT1080.

The internal amplifier forces V_{SENSE} across internal resistance R_{GT} causing a current to flow through MOSFET M1. This current is then converted to a voltage by R_G . A ratio of 10:1 between R_G and R_{GT} creates the fixed gain of 10. The output is then buffered by the unity gain buffer.

The gain equation of the ZXCT1080 is:

$$V_{OUT} = I_L R_{SENSE} \frac{R_G}{R_{GT}} \times 1 = I_L \times R_{SENSE} \times 10$$

The maximum recommended differential input voltage, V_{SENSE} , is 150mV; it will however withstand voltages up to 800mV. This can be increased further by the inclusion of a resistor, R_{LIM} , between S- pin and the load; typical value is of the order of 10k .

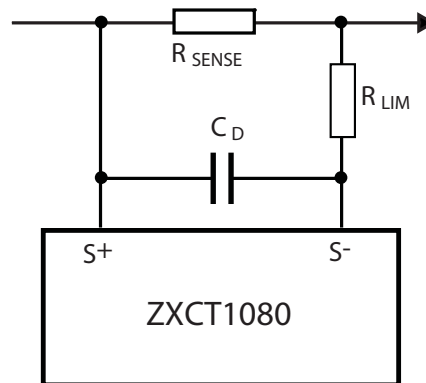

Figure 2 Protection/error sources for ZXCT1080

Capacitor C_D provides high frequency transient decoupling when used with R_{LIM}; typical values are of the order 10pF

For best performance R_{SENSE} should be connected as close to the S+ (and SENSE) pins; minimizing any series resistance with R_{SENSE}.

When choosing appropriate values for R_{SENSE} a compromise must be reached between in-line signal loss (including potential power dissipation effects) and small signal accuracy.

Higher values for R_{SENSE} gives better accuracy at low load currents by reducing the inaccuracies due to internal offsets. For best operation the ZXCT1080 has been designed to operate with V_{SENSE} of the order of 50mV to 150mV.

Current monitors' basic configuration is that of a unipolar voltage to current to voltage converter powered from a single supply rail. The internal amplifier at the heart of the current monitor may well have a bipolar offset voltage but the output cannot go negative; this results in current monitors saturating at very low sense voltages.

As a result of this phenomenon the ZXCT1080 has been specified to operate in a linear manner over a V_{SENSE} range of 10mV to 150mV range, however it will still be monotonic down to V_{SENSE} of 0V.

It is for this very reason that Zetex has specified an input offset voltage (V_{O(10)}) at 10mV. The output voltage for any V_{SENSE} voltage from 10mV to 150mV can be calculated as follows:

$$V_{OUT} = (V_{SENSE}) \times G + V_{O(10)}$$

Alternatively the load current can be expressed as:

$$I_L = \frac{(V_{OUT} - V_{O(10)})}{G \times R_{SENSE}}$$

Package details - SOT23-5

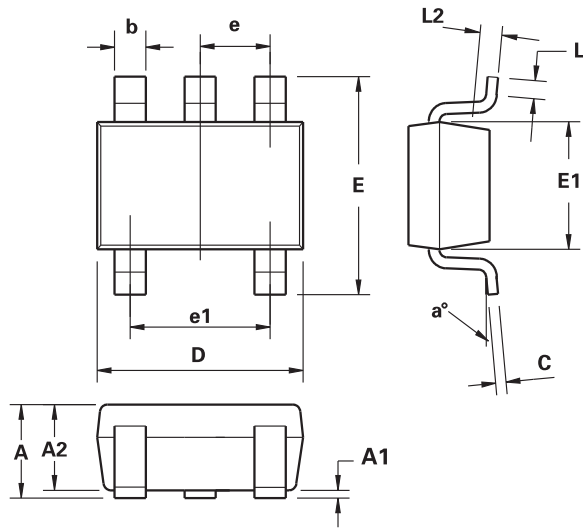

DIM	Millimeters		Inches	
	Min.	Max.	Min.	Max.
A	-	1.00	-	0.0393
A1	0.01	0.10	0.0003	0.0039
A2	0.84	0.90	0.0330	0.0354
b	0.30	0.45	0.0118	0.0177
c	0.12	0.20	0.0047	0.0078
D	2.90 BSC		0.114 BSC	
E	2.80 BSC		0.110 BSC	
E1	1.60 BSC		0.062 BSC	
e	0.95 BSC		0.0374 BSC	
e1	1.90 BSC		0.0748 BSC	
L	0.30	0.50	0.0118	0.0196
L2	0.25 BSC		0.010 BSC	
a°	4°	12°	4°	12°

Note: Controlling dimensions are in millimeters. Approximate dimensions are provided in inches

Intentionally left blank

Definitions

Product change

Zetex Semiconductors reserves the right to alter, without notice, specifications, design, price or conditions of supply of any product or service. Customers are solely responsible for obtaining the latest relevant information before placing orders.

Applications disclaimer

The circuits in this design/application note are offered as design ideas. It is the responsibility of the user to ensure that the circuit is fit for the user's application and meets with the user's requirements. No representation or warranty is given and no liability whatsoever is assumed by Zetex with respect to the accuracy or use of such information, or infringement of patents or other intellectual property rights arising from such use or otherwise. Zetex does not assume any legal responsibility or will not be held legally liable (whether in contract, tort (including negligence), breach of statutory duty, restriction or otherwise) for any damages, loss of profit, business, contract, opportunity or consequential loss in the use of these circuit applications, under any circumstances.

Life support

Zetex products are specifically not authorized for use as critical components in life support devices or systems without the express written approval of the Chief Executive Officer of Zetex Semiconductors plc. As used herein:

A. Life support devices or systems are devices or systems which:

1. are intended to implant into the body

or

2. support or sustain life and whose failure to perform when properly used in accordance with instructions for use provided in the labelling can be reasonably expected to result in significant injury to the user.

B. A critical component is any component in a life support device or system whose failure to perform can be reasonably expected to cause the failure of the life support device or to affect its safety or effectiveness.

Reproduction

The product specifications contained in this publication are issued to provide outline information only which (unless agreed by the company in writing) may not be used, applied or reproduced for any purpose or form part of any order or contract or be regarded as a representation relating to the products or services concerned.

Terms and Conditions

All products are sold subjects to Zetex' terms and conditions of sale, and this disclaimer (save in the event of a conflict between the two when the terms of the contract shall prevail) according to region, supplied at the time of order acknowledgement.

For the latest information on technology, delivery terms and conditions and prices, please contact your nearest Zetex sales office.

Quality of product

Zetex is an ISO 9001 and TS16949 certified semiconductor manufacturer.

To ensure quality of service and products we strongly advise the purchase of parts directly from Zetex Semiconductors or one of our regionally authorized distributors. For a complete listing of authorized distributors please visit: www.zetex.com/salesnetwork

Zetex Semiconductors does not warrant or accept any liability whatsoever in respect of any parts purchased through unauthorized sales channels.

ESD (Electrostatic discharge)

Semiconductor devices are susceptible to damage by ESD. Suitable precautions should be taken when handling and transporting devices. The possible damage to devices depends on the circumstances of the handling and transporting, and the nature of the device. The extent of damage can vary from immediate functional or parametric malfunction to degradation of function or performance in use over time. Devices suspected of being affected should be replaced.

Green compliance

Zetex Semiconductors is committed to environmental excellence in all aspects of its operations which includes meeting or exceeding regulatory requirements with respect to the use of hazardous substances. Numerous successful programs have been implemented to reduce the use of hazardous substances and/or emissions.

All Zetex components are compliant with the RoHS directive, and through this it is supporting its customers in their compliance with WEEE and ELV directives.

Product status key:

"Preview"	Future device intended for production at some point. Samples may be available
"Active"	Product status recommended for new designs
"Last time buy (LTB)"	Device will be discontinued and last time buy period and delivery is in effect
"Not recommended for new designs"	Device is still in production to support existing designs and production
"Obsolete"	Production has been discontinued

Datasheet status key:

"Draft version"	This term denotes a very early datasheet version and contains highly provisional information, which may change in any manner without notice.
"Provisional version"	This term denotes a pre-release datasheet. It provides a clear indication of anticipated performance. However, changes to the test conditions and specifications may occur, at any time and without notice.
"Issue"	This term denotes an issued datasheet containing finalized specifications. However, changes to specifications may occur, at any time and without notice.

Zetex sales offices

Europe	Americas	Asia Pacific	Corporate Headquarters
Zetex GmbH Kustermannpark Balanstraße 59 D-81541 München Germany Telephone: (49) 89 45 49 49 0 Fax: (49) 89 45 49 49 49 europe.sales@zetex.com	Zetex Inc 700 Veterans Memorial Highway Hauppauge, NY 11788 USA Telephone: (1) 631 360 2222 Fax: (1) 631 360 8222 usa.sales@zetex.com	Zetex (Asia Ltd) 3701-04 Metroplaza Tower 1 Hing Fong Road, Kwai Fong Hong Kong Telephone: (852) 26100 611 Fax: (852) 24250 494 asia.sales@zetex.com	Zetex Semiconductors plc Zetex Technology Park, Chadderton Oldham, OL9 9LL United Kingdom Telephone: (44) 161 622 4444 Fax: (44) 161 622 4446 hq@zetex.com

© 2007 Published by Zetex Semiconductors plc