

DATA SHEET

SKY12322-86LF: GaAs Digital Attenuator

500 MHz–4 GHz 5 Bits, 0.5 dB LSB

Features

- Broadband: 500 MHz–4 GHz
- Single positive control voltage: 2.7–5.5 V
- Low current consumption: <100 μ A @ 3 V
- Small MSOP-10 package
- Least significant bit attenuation: 0.5 dB
- Attenuation range: 15.5 dB
- High Input IP3: 45 dBm
- Available lead (Pb)-free and RoHS-compliant MSL-1 @ 260 °C per JEDEC J-STD-020

Applications

- Transceiver transmit automatic level control or receive automatic gain control in GSM, CDMA, WCDMA, WLAN, Bluetooth®, Zigbee®, land mobile radio base stations or terminal equipment
- General-purpose signal attenuation in telecommunications and instrumentation applications

Description

The SKY12322-86LF is a monolithic GaAs, binary-weighted, 5-bit, single-positive-control voltage digital attenuator which operates from 500 MHz to 4 GHz. The attenuator has a least significant bit (LSB) of 0.5 dB and total attenuation of 15.5 dB. The two RF ports are bilateral; each can be used as the RF input or the RF output. This attenuator requires an external supply voltage of 2.7–5.5 V.

The SKY12322-86LF is comprised of 5 fixed attenuators in cascade, each of which having a shunt bypass switch. Beginning at the LSB, which is 0.5 dB, each succeeding fixed attenuator produces twice the attenuation of the preceding stage. The state of each bypass switch is controlled by the logic level voltage applied to the associated control voltage input; a logic high voltage closes the associated switch, thereby bypassing that fixed attenuator stage, and a logic low opens the switch to force the input signal to that stage through the associated attenuator.

Functional Block Diagram

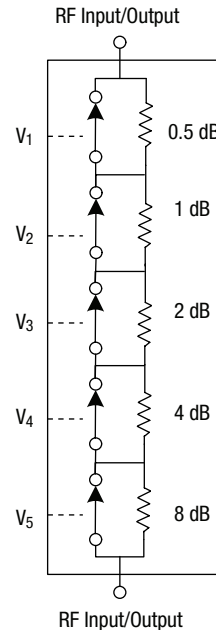

DC power consumption is very low, 100 μ A maximum with control voltage and supply voltage of 3 V. The switch can operate over the temperature range of -40 °C to +85 °C.

An evaluation board is available upon request.

NEW Skyworks offers lead (Pb)-free, RoHS (Restriction of Hazardous Substances)-compliant packaging.



Electrical Specifications at 25°C

V_{CTL} = 0 V/3 V, T = 25 °C, P_{INPUT} = 0 dBm, Z₀ = 50 Ω, unless otherwise noted

Parameter	Frequency	Min.	Typ.	Max.	Unit
Insertion loss	500 MHz–1 GHz		1.4	2.0	dB
	1–2 GHz		1.5	2.5	dB
	2–3 GHz		2.3	3.0	dB
	3–4 GHz		3.0	3.5	dB
Attenuation range ⁽¹⁾			15.5		dB
Attenuation accuracy ⁽¹⁾	500 MHz–1 GHz	± (0.2 + 3% of attenuation setting in dB)			dB
	1–3 GHz	± (0.3 + 5% of attenuation setting in dB)			dB
	3–4 GHz	± (0.5 + 5% of attenuation setting in dB)			dB
Return loss	500 MHz–4 GHz	10	20		dB

1. Attenuation referenced to insertion loss.

Operating Characteristics at 25°C

V_{CTL} = 0 V/3 V, T = 25 °C, P_{INPUT} = 0 dBm, Z₀ = 50 Ω, unless otherwise noted

Parameter	Condition	Frequency	Min.	Typ.	Max.	Unit
Switching characteristics						
Rise, fall	10/90% or 90/10% RF			150		ns
On, off	50% CTL to 90/10% RF			300		ns
Video feedthru	T _{RISE} = 1 ns, BW = 500 MHz			70		mV
Input power for 1 dB compression	V _{LOW} = 0 V, V _{HIGH} = 3 V	0.9–4.0 GHz		21		dBm
	V _{LOW} = 0 V, V _{HIGH} = 5 V	0.9–4.0 GHz		27		dBm
Intermodulation intercept point (IP3)	For two-tone input power 5 dBm, Δf = 1 MHz					
	V _{LOW} = 0 V, V _{HIGH} = 3 V	0.9–4.0 GHz		45		dBm
	V _{LOW} = 0 V, V _{HIGH} = 5 V	0.9–4.0 GHz		45		dBm
Thermal resistance				25		°C/W
Supply voltage			V _{HIGH} - 0.2		V _{HIGH} + 0.2	V
Control voltages	V _{LOW} = 0 V @ 20 μA max. V _{HIGH} = 3 V @ 100 μA max. to 5 V @ 200 μA max. V _{HIGH} = 0.2 ≤ V _S ≤ V _{HIGH} + 0.2 V					

Typical Performance Data

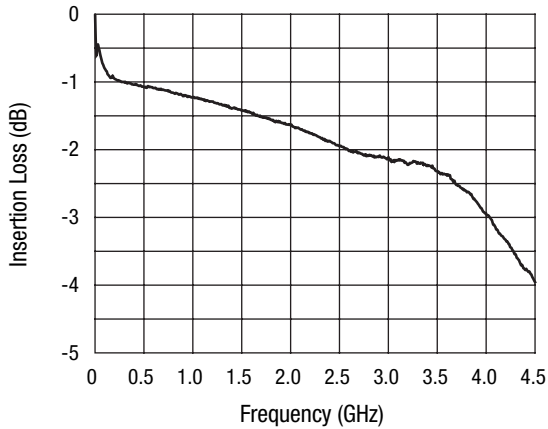

Insertion Loss vs. Frequency

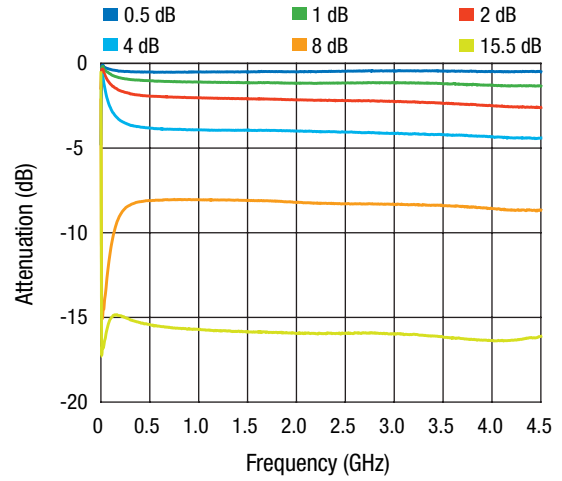

**Attenuation vs. Frequency,
Normalized to Insertion Loss**

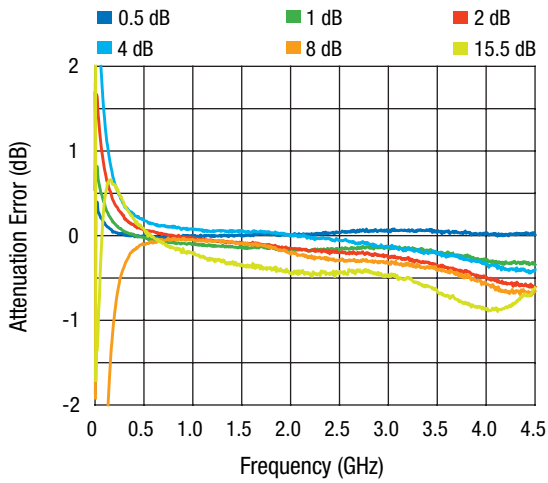

**Attenuation vs. Frequency,
Normalized to Insertion Loss**

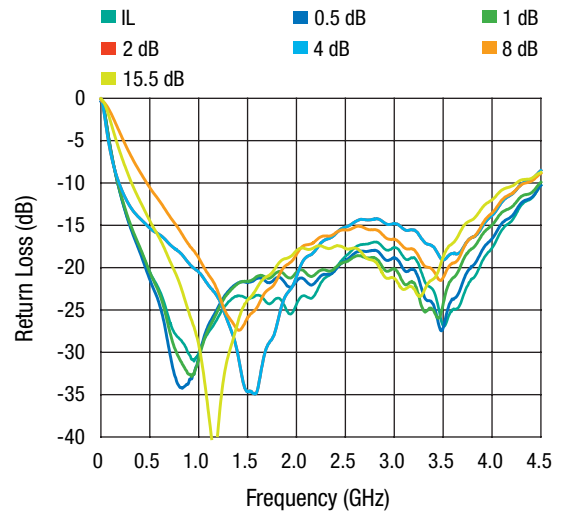

Insertion Loss vs. Frequency

Absolute Maximum Ratings

Characteristic	Value
RF input power	1 W for $f > 500$ MHz, $V_{CTL} = 0/8$ V 0.5 W for $f < 500$ MHz, $V_{CTL} = 0/8$ V
Supply voltage	$V_{HIGH} \pm 0.2$ V
Control voltage	-0.2 V $\leq V_C \leq 8$ V
Operating temperature	-40 °C to $+85$ °C
Storage temperature	-65 °C to $+150$ °C

Performance is guaranteed only under the conditions listed in the specifications table and is not guaranteed under the full range(s) described by the Absolute Maximum specifications. Exceeding any of the absolute maximum/minimum specifications may result in permanent damage to the device and will void the warranty.

CAUTION: Although this device is designed to be as robust as possible, ESD (Electrostatic Discharge) can damage this device. This device must be protected at all times from ESD. Static charges may easily produce potentials of several kilovolts on the human body or equipment, which can discharge without detection. Industry-standard ESD precautions must be employed at all times.

Truth Table

V ₁	V ₂	V ₃	V ₄	V ₅	Nominal Attenuation
V _{HIGH}	V _{HIGH}	V _{HIGH}	V _{HIGH}	V _{HIGH}	Reference I.L.
V _{LOW}	V _{HIGH}	V _{HIGH}	V _{HIGH}	V _{HIGH}	0.5 dB
V _{HIGH}	V _{LOW}	V _{HIGH}	V _{HIGH}	V _{HIGH}	1 dB
V _{HIGH}	V _{HIGH}	V _{LOW}	V _{HIGH}	V _{HIGH}	2 dB
V _{HIGH}	V _{HIGH}	V _{HIGH}	V _{LOW}	V _{HIGH}	4 dB
V _{HIGH}	V _{HIGH}	V _{HIGH}	V _{HIGH}	V _{LOW}	8 dB
V _{LOW}	V _{LOW}	V _{LOW}	V _{LOW}	V _{LOW}	15.5 dB

3 V $\leq V_{HIGH} \leq 5$ V, $V_S = V_{HIGH} \pm 0.2$ V, $0 \leq V_{LOW} \leq 0.2$ V.

Pin Out

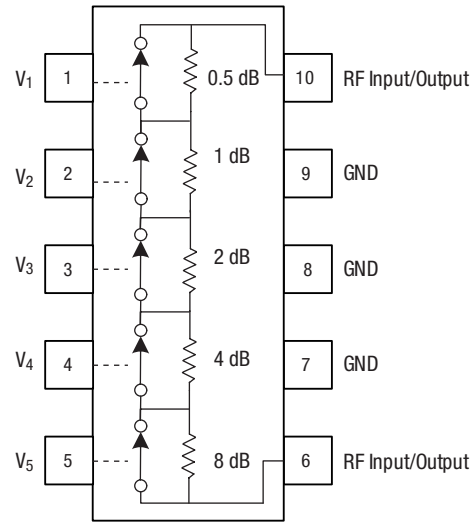

Pin Descriptions

Pin Number	Pin Name	Description
1	V ₁	Control Voltage – High Impedance control voltage input for 0.5 dB weighted bit (LSB)
2	V ₂	Control Voltage – High Impedance control voltage input for 1 dB weighted bit
3	V ₃	Control Voltage – High Impedance control voltage input for 2 dB weighted bit
4	V ₄	Control Voltage – High Impedance control voltage input for 4 dB weighted bit
5	V ₅	Control Voltage – High Impedance control voltage input for 8 dB weighted bit (MSB)
6	J ₂	RF Input/Output – RF input or output port, supply voltage input
7, 8, 9	GND	Equipotential Point – Equipotential points for control voltages and RF circuits. Must be connected to pcb ground via lowest possible impedance
10	J ₁	RF Input/Output – RF input or output port

Evaluation Board

The evaluation board for SKY12322-86 allows the part to be fully exercised. The RF signal may be applied to J₁ or to J₂ without change in performance. The supply voltage (V_S) is applied to pin 6 via R₁. DC blocking capacitors (C₁ and C₂) are required at the RF ports. The values of R₁, C₁ and C₂ are shown in Evaluation Board Components Table.

The attenuation produced by the SKY12322-86 is determined by the voltages applied to the high impedance control voltage ports V₁ through V₅. Each control voltage port determines whether its asso-

ciated attenuation bit, as listed in the Truth Table, is switched into or out of the RF signal path. Each of these control voltage ports must be held at 0 V (V_{LOW}) or at V_S ± 0.2 V (V_{HIGH}). The supply voltage must be within 0.2 V of V_{HIGH} or damage may result. Any combination of V_{HIGH} and V_{LOW} may be applied to ports V₁ through V₅. For example, if the desired attenuation value is 5.5 dB, V_{LOW} is applied to the 0.5 dB, 1 dB and 4 dB voltage control ports, which are V₁, V₂ and V₄, respectively. V_{HIGH} is applied to the remaining voltage control ports to ensure that their attenuation bits are not switched in to the RF signal path.

Evaluation Circuit PCB

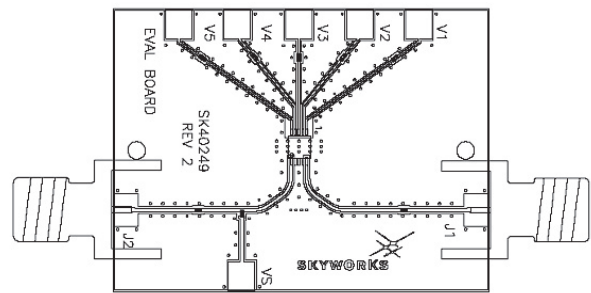
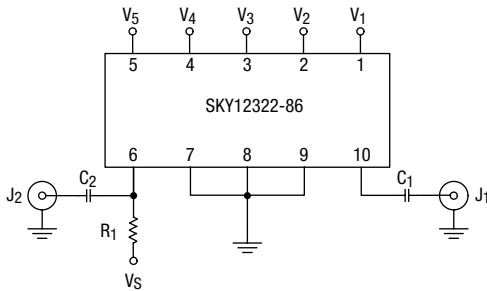

Evaluation Board Components

Component	Description	Default
C ₁ , C ₂	DC blocking capacitor	47 pF, size 0402
R ₁	RF block	10k Ω, size 0402
U ₁	GaAs digital attenuator	
J ₁ , J ₂	SMA connectors	

MSOP-10

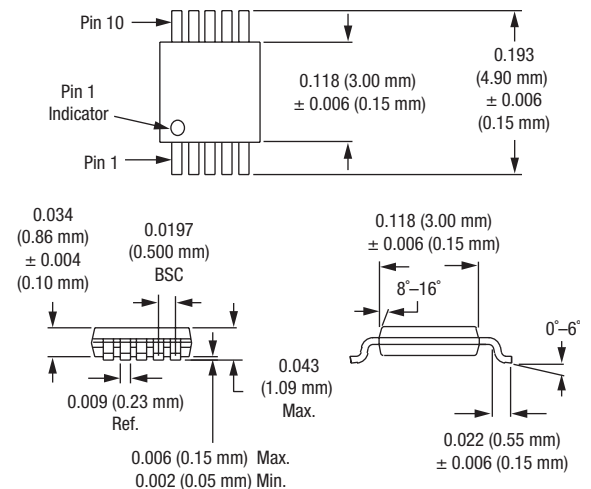

Recommended Solder Reflow Profiles

Refer to the [“Recommended Solder Reflow Profile”](#) Application Note.

Tape and Reel Information

Refer to the [“Discrete Devices and IC Switch/Attenuators Tape and Reel Package Orientation”](#) Application Note.

Copyright © 2002, 2003, 2004, 2005, 2006, Skyworks Solutions, Inc. All Rights Reserved.

Information in this document is provided in connection with Skyworks Solutions, Inc. ("Skyworks") products or services. These materials, including the information contained herein, are provided by Skyworks as a service to its customers and may be used for informational purposes only by the customer. Skyworks assumes no responsibility for errors or omissions in these materials or the information contained herein. Skyworks may change its documentation, products, services, specifications or product descriptions at any time, without notice. Skyworks makes no commitment to update the materials or information and shall have no responsibility whatsoever for conflicts, incompatibilities, or other difficulties arising from any future changes.

No license, whether express, implied, by estoppel or otherwise, is granted to any intellectual property rights by this document. Skyworks assumes no liability for any materials, products or information provided hereunder, including the sale, distribution, reproduction or use of Skyworks products, information or materials, except as may be provided in Skyworks Terms and Conditions of Sale.

THE MATERIALS, PRODUCTS AND INFORMATION ARE PROVIDED "AS IS" WITHOUT WARRANTY OF ANY KIND, WHETHER EXPRESS, IMPLIED, STATUTORY, OR OTHERWISE, INCLUDING FITNESS FOR A PARTICULAR PURPOSE OR USE, MERCHANTABILITY, PERFORMANCE, QUALITY OR NON-INFRINGEMENT OF ANY INTELLECTUAL PROPERTY RIGHT; ALL SUCH WARRANTIES ARE HEREBY EXPRESSLY DISCLAIMED. SKYWORKS DOES NOT WARRANT THE ACCURACY OR COMPLETENESS OF THE INFORMATION, TEXT, GRAPHICS OR OTHER ITEMS CONTAINED WITHIN THESE MATERIALS. SKYWORKS SHALL NOT BE LIABLE FOR ANY DAMAGES, INCLUDING BUT NOT LIMITED TO ANY SPECIAL, INDIRECT, INCIDENTAL, STATUTORY, OR CONSEQUENTIAL DAMAGES, INCLUDING WITHOUT LIMITATION, LOST REVENUES OR LOST PROFITS THAT MAY RESULT FROM THE USE OF THE MATERIALS OR INFORMATION, WHETHER OR NOT THE RECIPIENT OF MATERIALS HAS BEEN ADVISED OF THE POSSIBILITY OF SUCH DAMAGE.

Skyworks products are not intended for use in medical, lifesaving or life-sustaining applications, or other equipment in which the failure of the Skyworks products could lead to personal injury, death, physical or environmental damage. Skyworks customers using or selling Skyworks products for use in such applications do so at their own risk and agree to fully indemnify Skyworks for any damages resulting from such improper use or sale.

Customers are responsible for their products and applications using Skyworks products, which may deviate from published specifications as a result of design defects, errors, or operation of products outside of published parameters or design specifications. Customers should include design and operating safeguards to minimize these and other risks. Skyworks assumes no liability for applications assistance, customer product design, or damage to any equipment resulting from the use of Skyworks products outside of stated published specifications or parameters.

Skyworks, the Skyworks symbol, and "Breakthrough Simplicity" are trademarks or registered trademarks of Skyworks Solutions, Inc., in the United States and other countries. Third-party brands and names are for identification purposes only, and are the property of their respective owners. Additional information, including relevant terms and conditions, posted at www.skyworksinc.com, are incorporated by reference.