

# SG2001/A

# 150mA, Low Power, Low Noise, Low Dropout, Linear Regulators

## GENERAL DESCRIPTION

The SG2001/A series low-power, low-noise, low-dropout, CMOS linear voltage regulators operate from a 2.5V to 5.5V input and deliver up to 150mA. They are the perfect choice for low voltage, low power applications. An ultra low ground current (100 $\mu$ A at 150mA output) makes these parts attractive for battery operated power systems. The SG2001/A series also offer ultra low dropout voltage (105mV at 150mA output) to prolong battery life in portable electronics. Systems requiring a quiet voltage source, such as RF applications, will benefit from the SG2001/A series' ultra low output noise (30 $\mu$ VRMS). An external noise bypass capacitor connected to the device's BP pin can further reduce the noise level.

The output voltage is preset to voltages in the range of 1.2V to 5.0V. Other features include a 10nA logic-controlled shutdown mode, foldback current limit and thermal shutdown protection.

Devices come in 5-pin SOT23 package.

## FEATURES

- Low Output Noise: 30 $\mu$ VRMS typ(10Hz to 100KHz)
- Ultra-Low Dropout Voltage:  
105mV at 150mA output
- Low 77 $\mu$ A No-Load Supply Current
- Low 100 $\mu$ A Operating Supply Current  
at 150mA Output
- Thermal-Overload Protection
- Output Current Limit
- Preset Output Voltages ( $\pm$ 1.6% Accuracy)
- 10nA Logic-Controlled Shutdown
- Available in Multiple Output Voltage Versions  
Fixed Outputs of 1.2V, 1.5V, 1.8V, 2.5V, 2.8V,  
2.85V, 3.0V, 3.3V, 3.6V, and 5.0V  
Adjustable Output from 1.5V to 5.0V

## APPLICATIONS

Cellular Telephones  
Cordless Telephones  
PHS Telephones  
PCMCIA Cards  
Modems  
MP3 Player  
Hand-Held Instruments  
Palmtop Computers  
Electronic Planners  
Portable/Battery-Powered Equipment

## PIN CONFIGURATIONS (TOP VIEW)

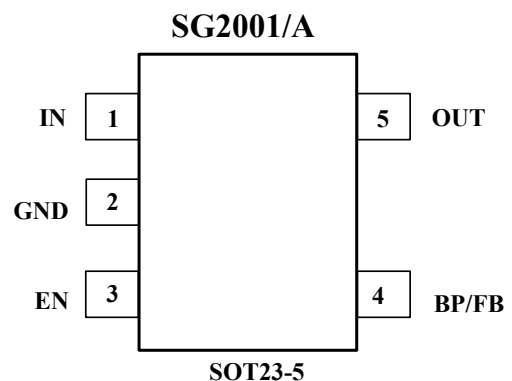

## ORDERING INFORMATION

MODEL	V <sub>OUT</sub> (V)	PIN-PACKAGE	SPECIFIED TEMPERATURE RANGE	ORDERING NUMBER	PACKAGE MARKING	PACKAGE OPTION
SG2001-1.2	1.2V	SOT23-5	- 40°C to +125°C	SG2001-1.2XN5/TR	X112	Tape and Reel, 3000
SG2001-1.5	1.5V	SOT23-5	- 40°C to +125°C	SG2001-1.5XN5/TR	X115	Tape and Reel, 3000
SG2001-1.8	1.8V	SOT23-5	- 40°C to +125°C	SG2001-1.8XN5/TR	X118	Tape and Reel, 3000
SG2001-2.5	2.5V	SOT23-5	- 40°C to +125°C	SG2001-2.5XN5/TR	X125	Tape and Reel, 3000
SG2001-2.8	2.8V	SOT23-5	- 40°C to +125°C	SG2001-2.8XN5/TR	X128	Tape and Reel, 3000
SG2001-2.85	2.85V	SOT23-5	- 40°C to +125°C	SG2001-2.85XN5/TR	X12J	Tape and Reel, 3000
SG2001-3.0	3.0V	SOT23-5	- 40°C to +125°C	SG2001-3.0XN5/TR	X130	Tape and Reel, 3000
SG2001-3.3	3.3V	SOT23-5	- 40°C to +125°C	SG2001-3.3XN5/TR	X133	Tape and Reel, 3000
SG2001-3.6	3.6V	SOT23-5	- 40°C to +125°C	SG2001-3.6XN5/TR	X136	Tape and Reel, 3000
SG2001-5.0	5.0V	SOT23-5	- 40°C to +125°C	SG2001-5.0XN5/TR	X150	Tape and Reel, 3000
SG2001A	adjustable	SOT23-5	- 40°C to +125°C	SG2001-XN5/TR	X1AA	Tape and Reel, 3000

## ABSOLUTE MAXIMUM RATINGS

IN to GND..... - 0.3V to +6V  
 Output Short-Circuit Duration .....Infinite  
 EN to GND..... - 0.3V to +6V  
 OUT, BP/FB to GND.....- 0.3V to (V<sub>IN</sub> + 0.3V)  
 Power Dissipation, P<sub>D</sub> @ T<sub>A</sub> = 25°C  
 SOT23-5 .....0.4W  
 Package Thermal Resistance  
 SOT23-5, θ<sub>JA</sub>..... 250°C/W

Operating Temperature Range.....- 40°C to +125°C  
 Junction Temperature.....+150°C  
 Storage Temperature.....- 65°C to +150°C  
 Lead Temperature (soldering, 10s).....260°C  
 ESD Susceptibility  
 HBM.....7000V  
 MM.....400V

Stresses beyond those listed under “Absolute Maximum Ratings” may cause permanent damage to the device. These are stress ratings only, and functional operation of the device at these or any other conditions beyond those indicated in the operational sections of the specifications is not implied. Exposure to absolute maximum rating conditions for extended periods may affect device reliability.

## PIN DESCRIPTION

PIN	NAME	FUNCTION
1	IN	Regulator Input. Supply voltage can range from 2.5V to 5.5V. Bypass with a 1μF capacitor to GND.
2	GND	Ground.
3	EN	Shutdown Input. A logic low reduces the supply current to 10nA. Connect to IN for normal operation.
4	BP	Reference-Noise Bypass (fixed voltage version only). Bypass with a low-leakage 0.01μF ceramic capacitor for reduced noise at the output.
4	FB	Adjustable voltage version only — this is used to set the output voltage of the device.
5	OUT	Regulator Output.

# ELECTRICAL CHARACTERISTICS

( $V_{IN} = V_{OUT(NOMINAL)} + 0.5V$  or  $2.5V$  (whichever is greater),  $T_A = -40^{\circ}C$  to  $+125^{\circ}C$ , unless otherwise noted. Typical values are at  $T_A = +25^{\circ}C$ .)

PARAMETER	SYMBOL	CONDITIONS	MIN	TYP	MAX	UNITS	
Input Voltage	$V_{IN}$		2.5		5.5	V	
Output Voltage Accuracy		$I_{OUT} = 0.1mA, V_{OUT} \geq 2.5V, T_A = +25^{\circ}C$	-1.6		1.6	%	
		$I_{OUT} = 0.1mA$ to $150mA, V_{OUT} \geq 2.5V$ $T_A = 0^{\circ}C$ to $+70^{\circ}C$			2		
		$I_{OUT} = 0.1mA$ to $150mA, V_{OUT} \geq 2.5V$ $T_A = -40^{\circ}C$ to $+125^{\circ}C$			2.4		
		$I_{OUT} = 0.1mA$ to $150mA, 1.5V \leq V_{OUT} < 2.5V$ $T_A = -40^{\circ}C$ to $+125^{\circ}C$			2.6		
		$I_{OUT} = 0.1mA$ to $150mA, V_{OUT} = 1.2V$ $T_A = +25^{\circ}C$	2		6		
Maximum Output Current			150			mA	
Current Limit	$I_{LIM}$		160	600		mA	
Ground Pin Current	$I_Q$	No load, $EN = 2V$	$V_{OUT} \leq 3.3V$		77	130	$\mu A$
			$V_{OUT} > 3.3V$		77	145	
		$I_{OUT} = 150mA, EN = 2V$			100		
Dropout Voltage(Note1)		$I_{OUT} = 1mA$		0.8		mV	
		$I_{OUT} = 150mA$		105	170		
Line Regulation	$\Delta V_{LNR}$	$V_{IN} = 2.5V$ or $(V_{OUT} + 0.1V)$ to $5.5V,$ $I_{OUT} = 1mA$		0.004	0.15	%/V	
Load Regulation	$\Delta V_{LDR}$	$I_{OUT} = 0.1mA$ to $150mA, C_{OUT} = 1\mu F$		0.0005	0.002	%/mA	
Output Voltage Noise	$e_n$	$f = 10Hz$ to $100KHz, C_{BP} = 0.01\mu F,$ $C_{OUT} = 10\mu F$		30		$\mu VRMS$	
Power Supply Rejection Rate	PSRR	$C_{BP} = 0.1\mu F, I_{LOAD} = 50mA,$ $C_{OUT} = 1\mu F$	$f = 100Hz$		74		dB
			$f = 1KHz$		54		dB
<b>SHUTDOWN</b>							
EN Input Threshold	$V_{IH}$	$V_{IN} = 2.5V$ to $5.5V$	2.0			V	
	$V_{IL}$				0.4		
EN Input Bias Current	$I_{B(SHDN)}$	$EN = 0V$ and $EN = 5.5V$	$T_A = +25^{\circ}C$		0.01	1	$\mu A$
			$T_A = +125^{\circ}C$		0.01		
Shutdown Supply Current	$I_{Q(SHDN)}$	$EN = 0.4V$	$T_A = +25^{\circ}C$		0.01	1	$\mu A$
			$T_A = +125^{\circ}C$		0.01		
Shutdown Exit Delay(Note2)		$C_{BP} = 0.01\mu F$ $C_{OUT} = 1\mu F, No\ load$	$T_A = +25^{\circ}C$		30	$\mu s$	
<b>THERMAL PROTECTION</b>							
Thermal Shutdown Temperature	$T_{SHDN}$			160		$^{\circ}C$	
Thermal Shutdown Hysteresis	$\Delta T_{SHDN}$			15		$^{\circ}C$	

Specifications subject to change without notice.

**Note 1:** The dropout voltage is defined as  $V_{IN} - V_{OUT}$ , when  $V_{OUT}$  is 100mV below the value of  $V_{OUT}$  for  $V_{IN} = V_{OUT} + 0.5V$ . (Only applicable for  $V_{OUT} = +2.5V$  to  $+5.0V$ )

**Note 2:** Time needed for  $V_{OUT}$  to reach 95% of final value.

## TYPICAL OPERATION CIRCUIT

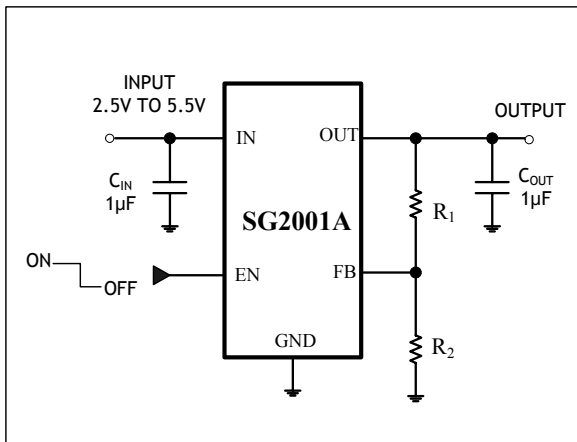

Adjustable Voltage Version

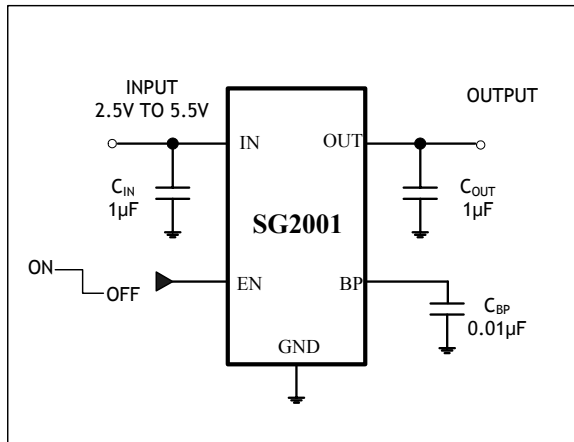

Fixed Voltage Version

### Standard 1% Resistor Values for Common Output Voltages of Adjustable Voltage Version

V <sub>OUT</sub> (V)	R <sub>1</sub> (kΩ)	R <sub>2</sub> (kΩ)
1.5	13	61.9
1.8	28	61.9
2.5	63.4	61.9
2.8	78.7	61.9
2.85	80.6	61.9
3.0	88.7	61.9
3.3	95.3	57.6
5.0	187	61.9

Note:  $V_{OUT} = (R_1 + R_2) / R_2 \times 1.2395$

# TYPICAL OPERATING CHARACTERISTICS

$V_{IN} = V_{OUT(NOMINAL)} + 0.5V$  or  $2.5V$  (whichever is greater),  $C_{IN} = 1\mu F$ ,  $C_{OUT} = 1\mu F$ ,  $C_{BP} = 0.01\mu F$ ,  $T_A = +25^\circ C$ , unless otherwise noted.

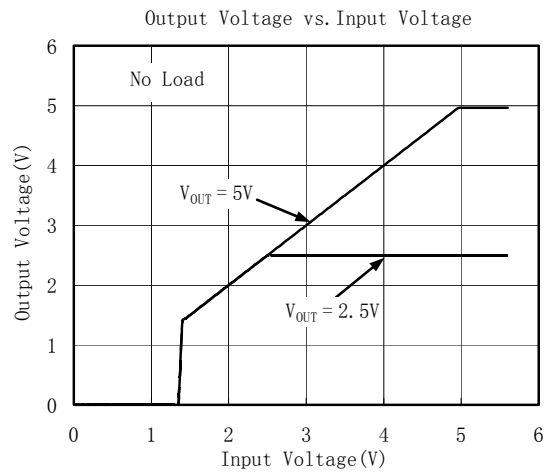
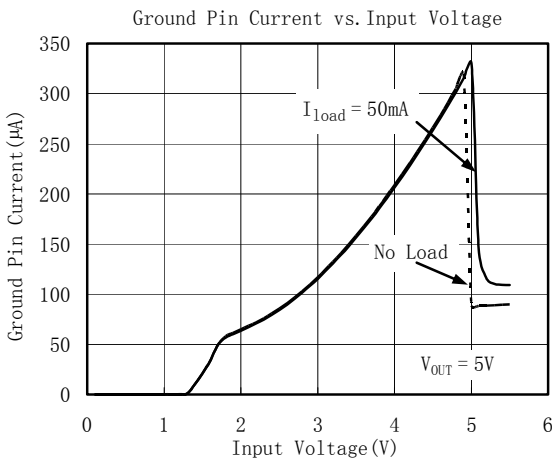
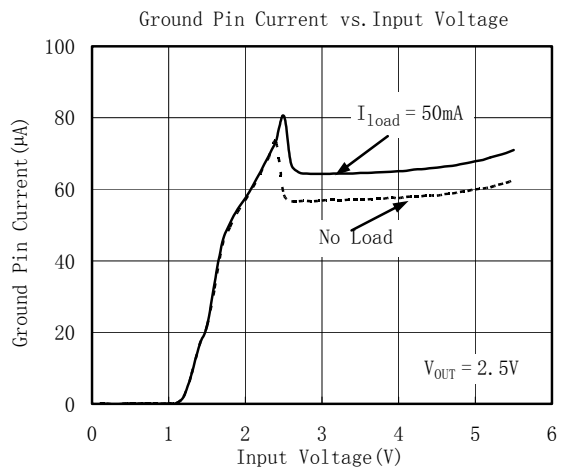
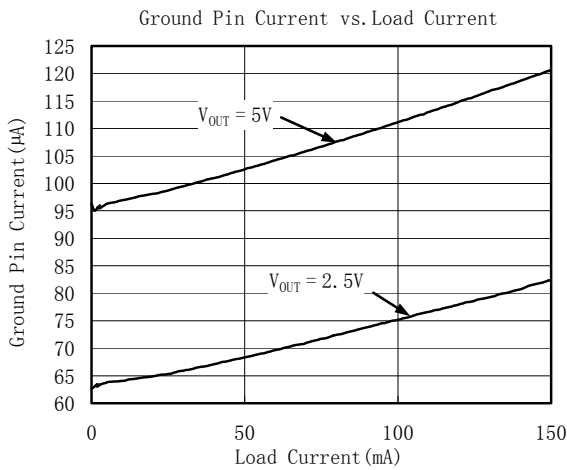
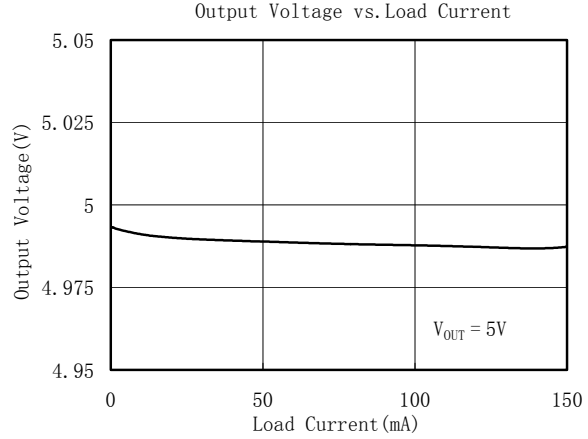
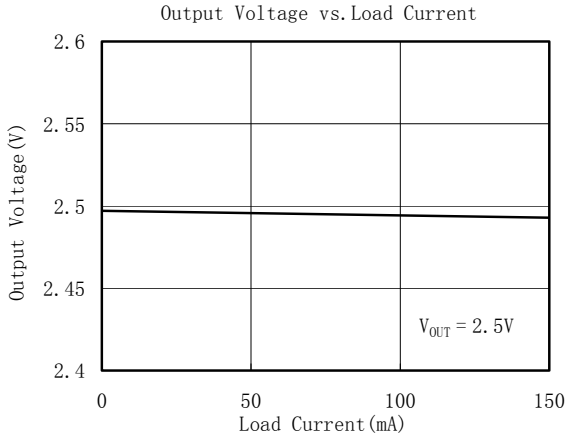

# TYPICAL OPERATING CHARACTERISTICS

$V_{IN} = V_{OUT(NOMINAL)} + 0.5V$  or  $2.5V$  (whichever is greater),  $C_{IN} = 1\mu F$ ,  $C_{OUT} = 1\mu F$ ,  $C_{BP} = 0.01\mu F$ ,  $T_A = +25^\circ C$ , unless otherwise noted.

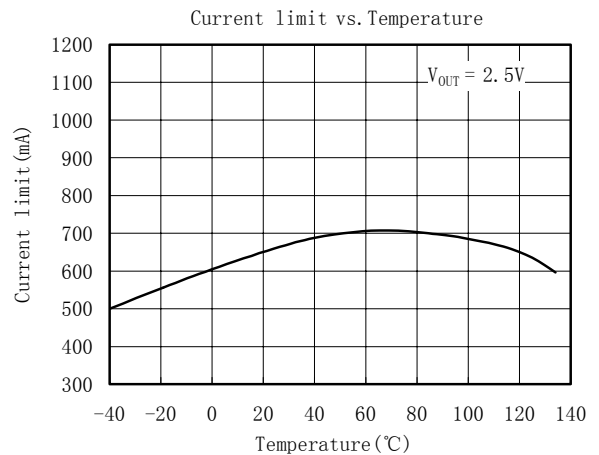
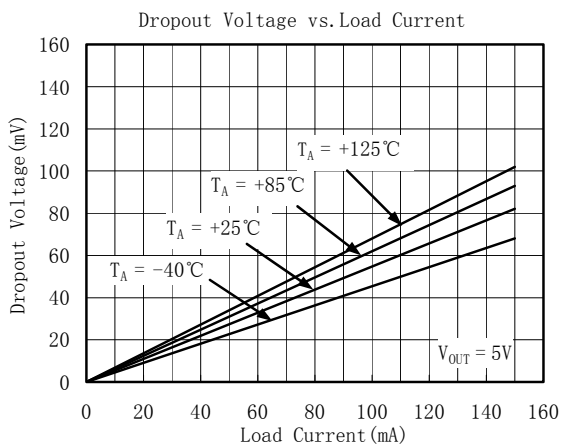
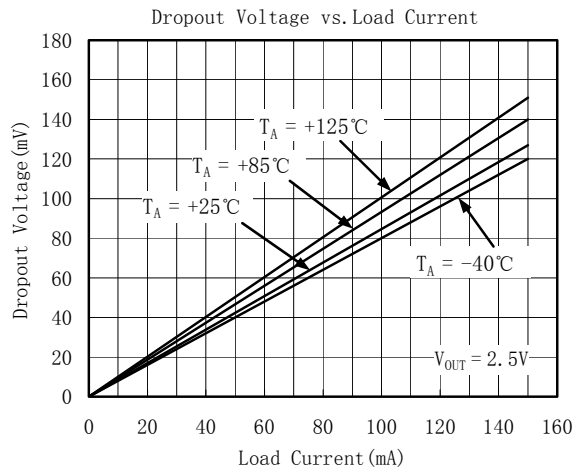
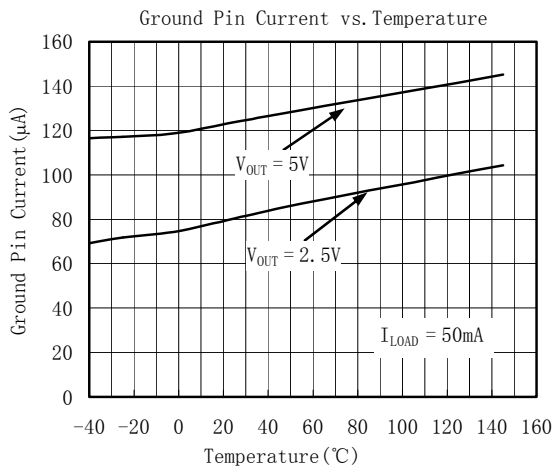
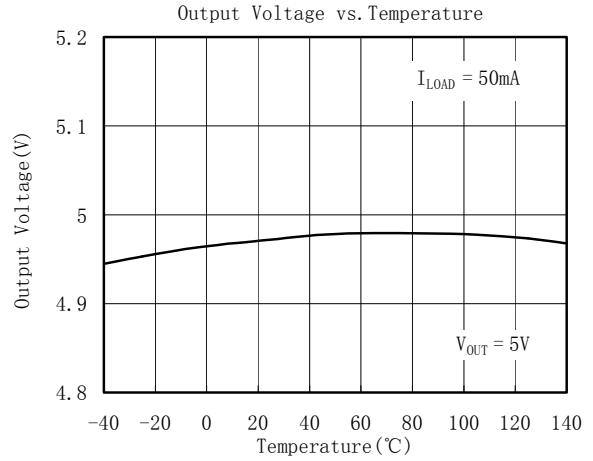
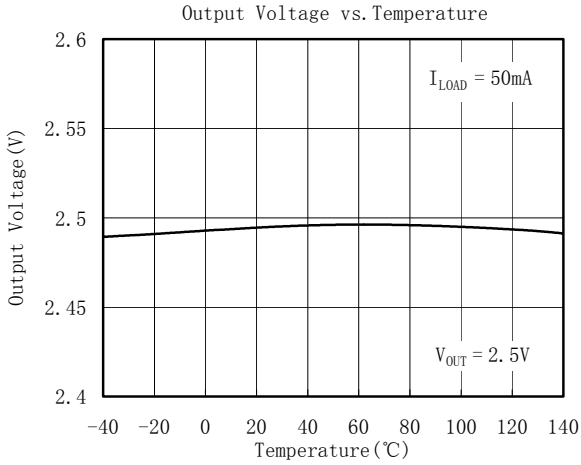

# TYPICAL OPERATING CHARACTERISTICS

$V_{IN} = V_{OUT(NOMINAL)} + 0.5V$  or  $2.5V$  (whichever is greater),  $C_{IN} = 1\mu F$ ,  $C_{OUT} = 1\mu F$ ,  $C_{BP} = 0.01\mu F$ ,  $T_A = +25^\circ C$ , unless otherwise noted.

Line-Transient Response

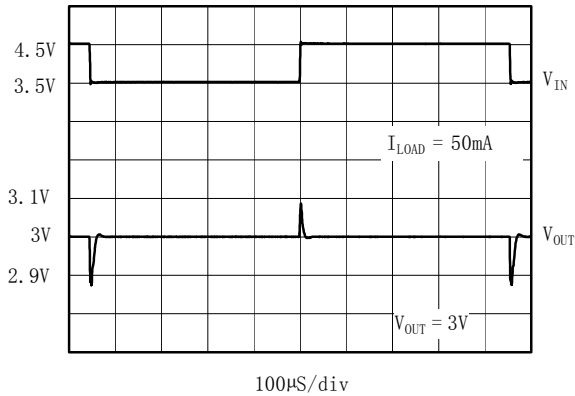

Load-Transient Response

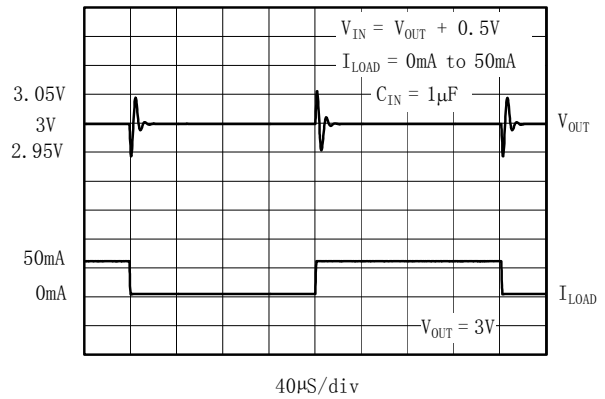

Load-Transient Response Near Dropout

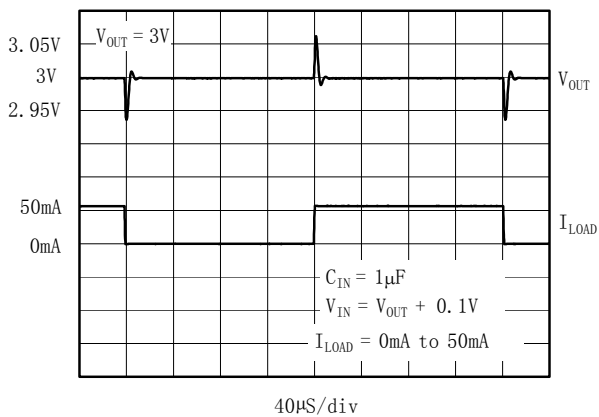

Shutdown Exit Delay

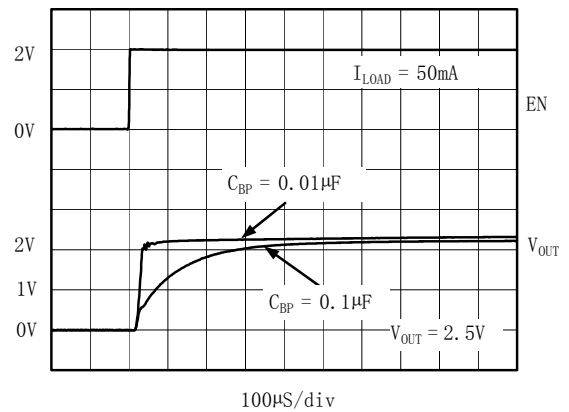

Shutdown Exit Delay

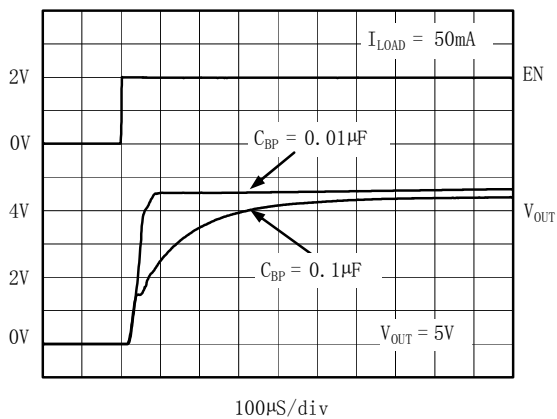

Entering Shutdown

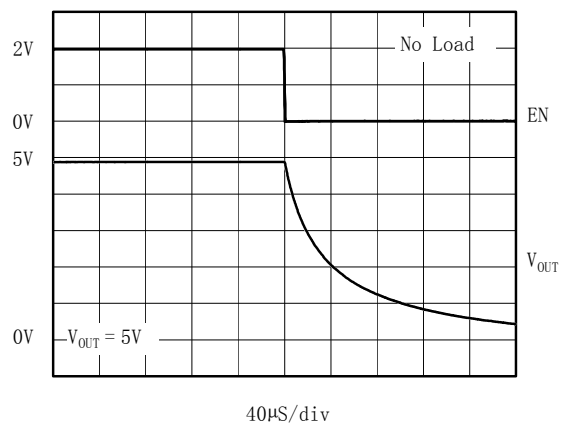

# TYPICAL OPERATING CHARACTERISTICS

$V_{IN} = V_{OUT(NOMINAL)} + 0.5V$  or  $2.5V$  (whichever is greater),  $C_{IN} = 1\mu F$ ,  $C_{OUT} = 1\mu F$ ,  $C_{BP} = 0.01\mu F$ ,  $T_A = +25^\circ C$ , unless otherwise noted.

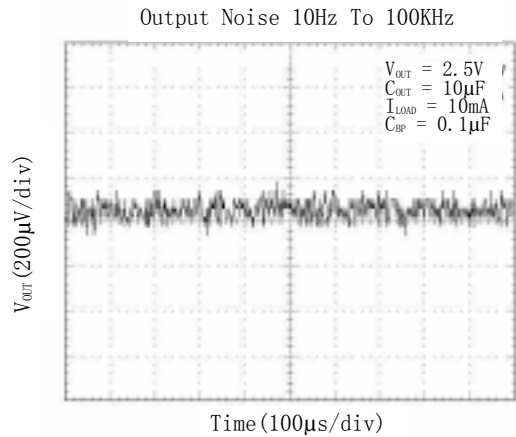
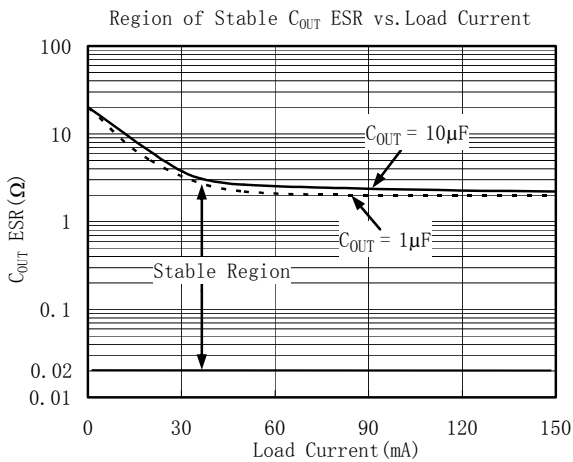
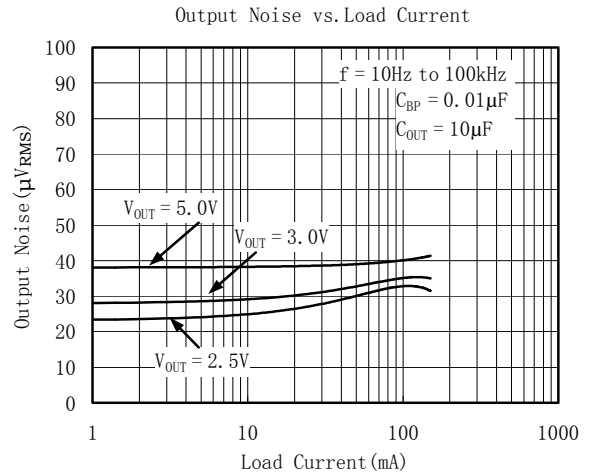
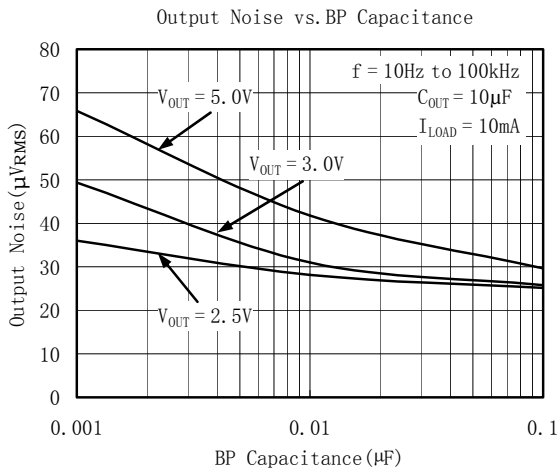
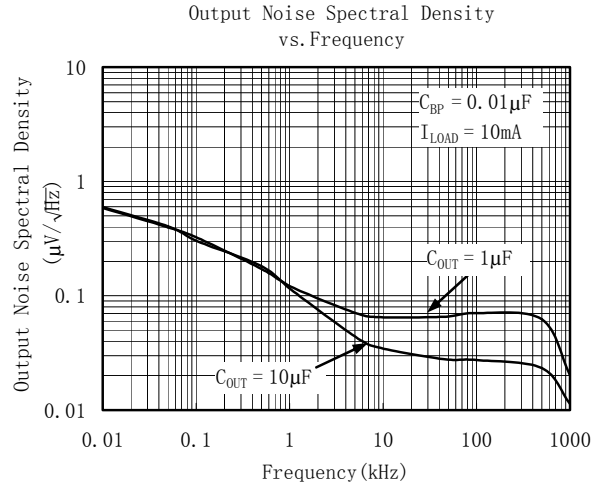
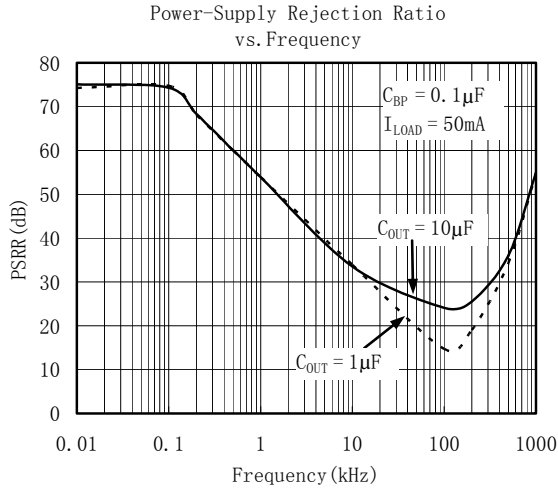



# TYPICAL OPERATING CHARACTERISTICS

$V_{IN} = V_{OUT(NOMINAL)} + 0.5V$  or  $2.5V$  (whichever is greater),  $C_{IN} = 1\mu F$ ,  $C_{OUT} = 1\mu F$ ,  $C_{BP} = 0.01\mu F$ ,  $T_A = +25^\circ C$ , unless otherwise noted.

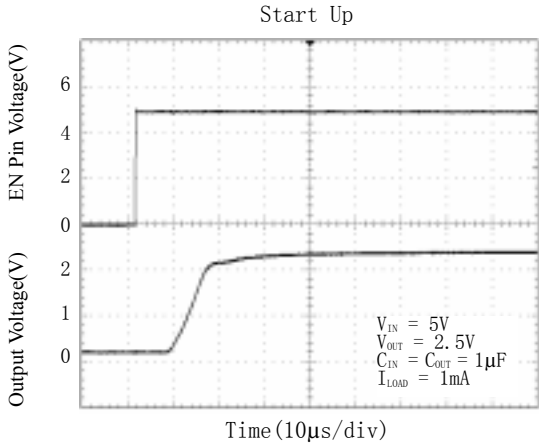

## Application Notes

When LDO is used in handheld products, Attention must be paid to voltage spike which would damage SG2001. In such applications, voltage spike will be generated at charger interface and  $V_{BUS}$  pin of USB interface when charger adapters and USB equipments are hot-inserted. Besides this, handheld products will be tested on the production line on the condition of no battery. Test Engineer will apply power from the connector pin which connects with positive pole of the battery. When external power supply is turned on suddenly, the voltage spike will be generated at the battery connector. The voltage spike will be very high, it always exceeds the absolute maximum input voltage (6.0V) of LDO. In order to get robust design. Design Engineer needs to clear up this voltage spike. Zener diode is a cheap and effective solution to eliminate such voltage spike. For example, BZM55B5V6 is a 5.6V small package Zener diode which can be used to remove voltage spike in cell phone design. The schematic is shown in below:

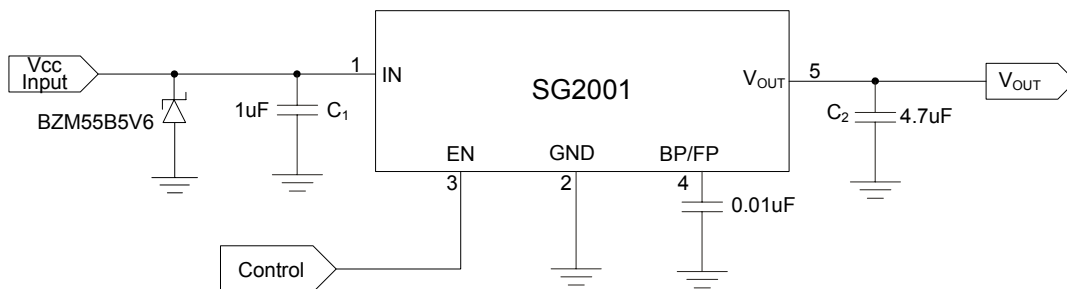

# PACKAGE OUTLINE DIMENSIONS

## SOT23-5

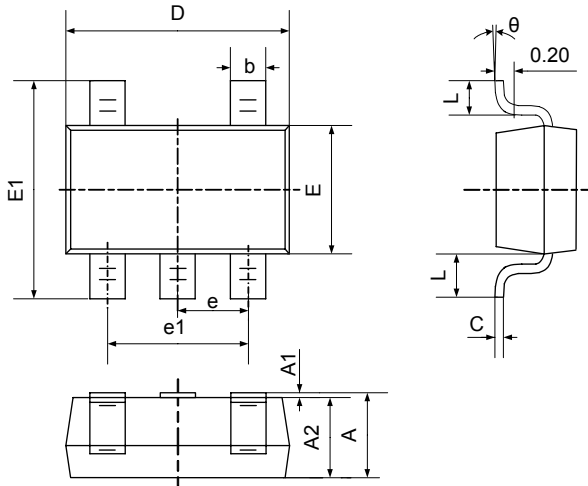

Symbol	Dimensions In Millimeters		Dimensions In Inches	
	Min	Max	Min	Max
A	1.050	1.250	0.041	0.049
A1	0.000	0.100	0.000	0.004
A2	1.050	1.150	0.041	0.045
b	0.300	0.400	0.012	0.016
c	0.100	0.200	0.004	0.008
D	2.820	3.020	0.111	0.119
E	1.500	1.700	0.059	0.067
E1	2.650	2.950	0.104	0.116
e	0.950TYP		0.037TYP	
e1	1.800	2.000	0.071	0.079
L	0.700REF		0.028REF	
L1	0.300	0.600	0.012	0.024
$\theta$	0°	8°	0°	8°

# REVISION HISTORY

Location	Page
9/05— Data Sheet changed from preliminary to REV. A	
12/06— Data Sheet changed from REV. A to REV. B	
Changed to ABSOLUTE MAXIMUM RATINGS .....	2
Added Application Notes .....	9

## Shengbang Microelectronics Co, Ltd

Unit 3, ChuangYe Plaza  
No.5, TaiHu Northern Street, YingBin Road Centralized Industrial Park  
Harbin Development Zone  
Harbin, HeiLongJiang 150078  
P.R. China  
Tel.: 86-451-84348461  
Fax: 86-451-84308461  
[www.sg-micro.com](http://www.sg-micro.com)