

SURFACE MOUNT LOW DROPOUT POSITIVE ADJUSTABLE REGULATOR

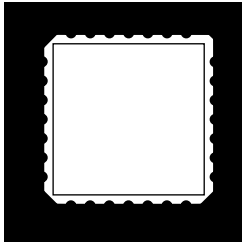

**Three Terminal, Adjustable Low Dropout
2.0 Amp And 1.0 Amp Positive
Voltage Regulators**

FEATURES

- Hermetic Surface Mount Package
- Operates Down To 1V Dropout, 1.5V @ Max. Current
- .020% Line Regulation Typically
- .050% Load Regulation Typically
- 1% Reference Voltage
- Electrically Equivalent To LT1085 And LT1086
- Available Hi-Rel Screened

DESCRIPTION

These three terminal positive adjustable voltage regulators in a surface mount package are designed to provide 2.0 Amps and 1.0 Amp with higher efficiency than conventional voltage regulators. The devices are designed to operate to 1 Volt input to output differential and the dropout voltage is specified as a function of load current. These devices are ideally suited for Hi-Rel applications where surface mount, small size, hermeticity and high reliability are required.

ABSOLUTE MAXIMUM RATINGS @ 25°C

Input Voltage	35 V
Operating Junction Temperature Range	- 55°C to + 150°C
Storage Temperature Range	- 55°C to + 150°C
Output Current -	OM185SM.....	2.0 A
	OM186SM.....	1.0 A
Thermal Resistance -	OM185SM.....	9°C/W
	OM186SM.....	14°C/W
Lead Temperature (Soldering 10 Seconds)	280°C

3.5

ELECTRICAL CHARACTERISTICS ($T_J = -55^{\circ}\text{C}$ to $+125^{\circ}\text{C}$)

Parameter	Conditions	Min.	Max.	Units
Reference Voltage	$I_{OUT} = 10\text{mA}$, $T_J = 25^{\circ}\text{C}$ $(V_{IN} - V_{OUT}) = 3\text{V}$	1.238	1.262	V
	10mA I_{OUT} $I_{FULL\,LOAD}$ 1.5V $(V_{IN} - V_{OUT})$ 25V (Note 3)	• 1.220	1.270	V
Line Regulation	$I_{LOAD} = 10\text{mA}$, 1.5V $(V_{IN} - V_{OUT})$ 15V , $T_J = 25^{\circ}\text{C}$		0.25	%
	15V $(V_{IN} - V_{OUT})$ 35V (Notes 1 & 2)	•	0.6	%
Load Regulation	$(V_{IN} - V_{OUT}) = 3\text{V}$ 10mA I_{OUT} $I_{FULL\,LOAD}$ $T_J = 25^{\circ}\text{C}$ (Notes 1, 2, & 3)		1.0	%
		•	1.2	%
Dropout Voltage	$V_{REF} = 1\%$, $I_{OUT} = I_{FULL\,LOAD}$	•	1.5	V
Current Limit	OM185SM	$(V_{IN} - V_{OUT}) = 5\text{V}$	• 2.0	A
		$(V_{IN} - V_{OUT}) = 25\text{V}$	• 0.10	A
	OM186SM	$(V_{IN} - V_{OUT}) = 5\text{V}$	• 1.0	A
		$(V_{IN} - V_{OUT}) = 25\text{V}$	• 0.05	A
Minimum Load Current	$(V_{IN} - V_{OUT}) = 25\text{V}$	•	15	mA
Thermal Regulation	$T_A = 25^{\circ}\text{C}$, 30 ms pulse		0.025	%/W
			0.055	%/W
Ripple Rejection	$f = 120\text{Hz}$ $C_{ADJ} = 25\mu\text{F}$ Tantalum $I_{OUT} - I_{FULL\,LOAD}$ $(V_{IN} - V_{OUT}) = 3\text{V}$	60		dB
Adjust Pin Current	$T_J = 25^{\circ}\text{C}$		120	μA
Adjust Pin Current Change	10mA I_{OUT} $I_{FULL\,LOAD}$ 1.5V $(V_{IN} - V_{OUT})$ 25V	•	5	μA
Temperature Stability	-55°C T_J $+150^{\circ}\text{C}$		1	%
Long Term Stability	$T_A = 125^{\circ}\text{C}$, 1000 Hrs.		1	%

Note 1: Load and line regulation are measured at a constant junction temperature by low duty cycle pulse testing.

Note 2: Line and load regulation are guaranteed up to the maximum power dissipation (OM185/20W, OM186/10W). Power dissipation is determined by the input/output differential and the output current. Guaranteed maximum power dissipation will not be available over the full input/output voltage range.

Note 3: $I_{FULL\,LOAD}$ curve is defined as the minimum value of current limit as a function of input to output voltage. Note that power dissipation is only achievable over a limited range of input to output voltage.

Note 4: Dropout voltage is specified over the full output current range of the device.

The • denotes the specifications which apply over the full operating temperature range.

3.5

TYPICAL PERFORMANCE CHARACTERISTICS

**OM186SM
LOAD REGULATION**

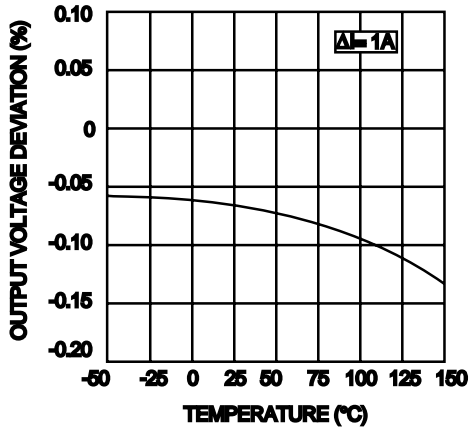

**OM185SM
LOAD REGULATION**

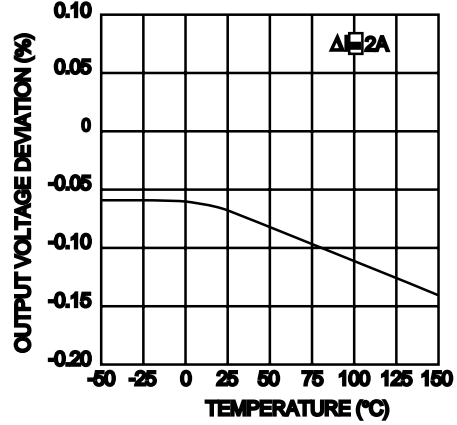

**OM186SM
TEMPERATURE STABILITY**

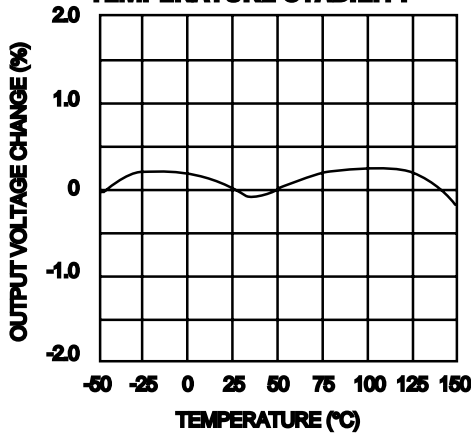

**OM185SM
TEMPERATURE STABILITY**

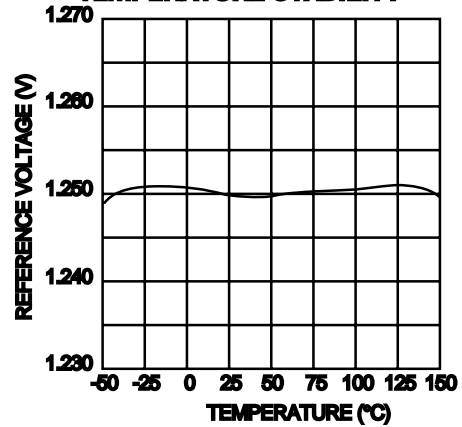

**OM186SM
SHORT CIRCUIT CURRENT**

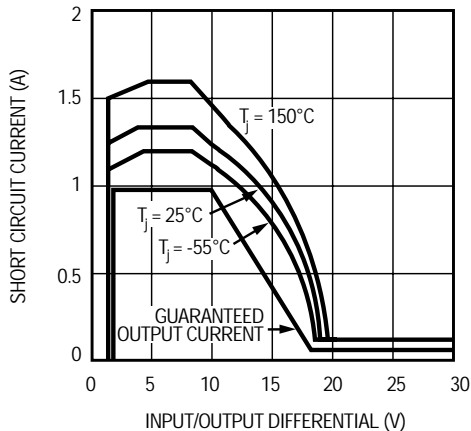

**OM185SM
SHORT CIRCUIT CURRENT**

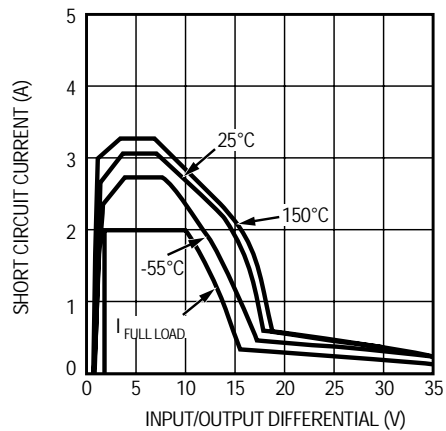

3.5

MECHANICAL OUTLINES

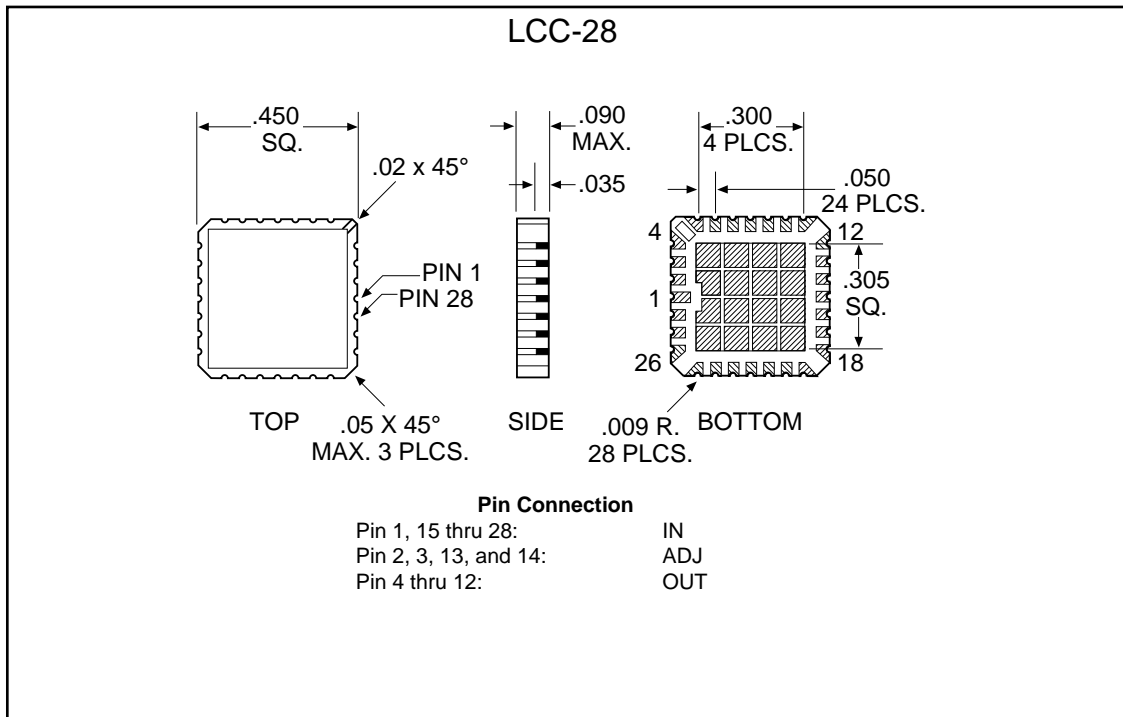
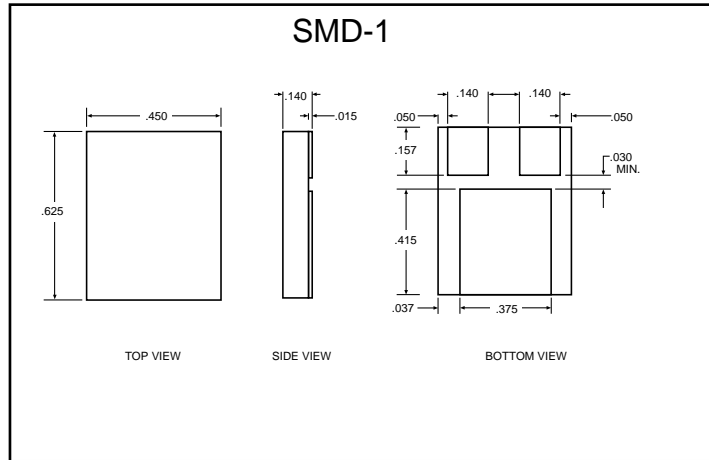
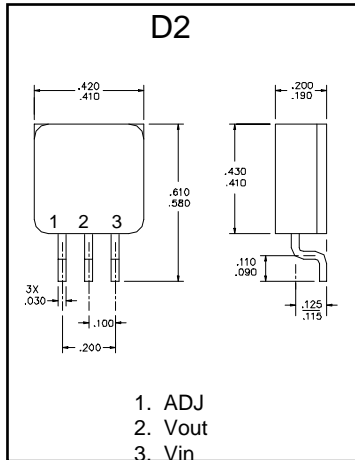

3.5