

IRS2117/IRS2118(S)PbF

SINGLE CHANNEL DRIVER

Features

- Floating channel designed for bootstrap operation
- Fully operational to +600 V
- Tolerant to negative transient voltage, dV/dt immune
- Gate drive supply range from 10 V to 20V
- Undervoltage lockout
- CMOS Schmitt-triggered inputs with pull-down
- Output in phase with input (IRS2117) or out of phase with input (IRS2118)
- RoHS compliant

Product Summary

V_{OFFSET}	600 V max.
$I_{\text{O}+/-}$	200 mA / 420 mA
V_{OUT}	10 V - 20 V
$t_{\text{on/off}}$ (typ.)	125 ns & 105 ns

Description

The IRS2117/IRS2118 are a high voltage, high speed power MOSFET and IGBT driver. Proprietary HVIC and latch immune CMOS technologies enable ruggedized monolithic construction. The logic input is compatible with standard CMOS outputs. The output driver features a high pulse current buffer stage designed for minimum cross-conduction. The floating channel can be used to drive an N-channel power MOSFET or IGBT in the high-side or low-side configuration which operates up to 600 V.

Packages

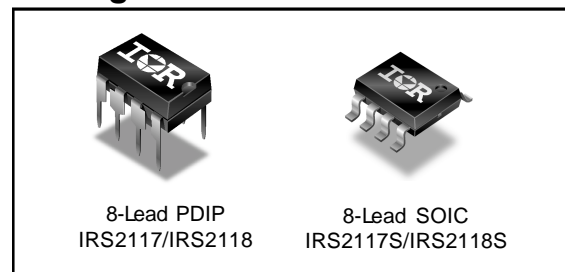

Typical Connection

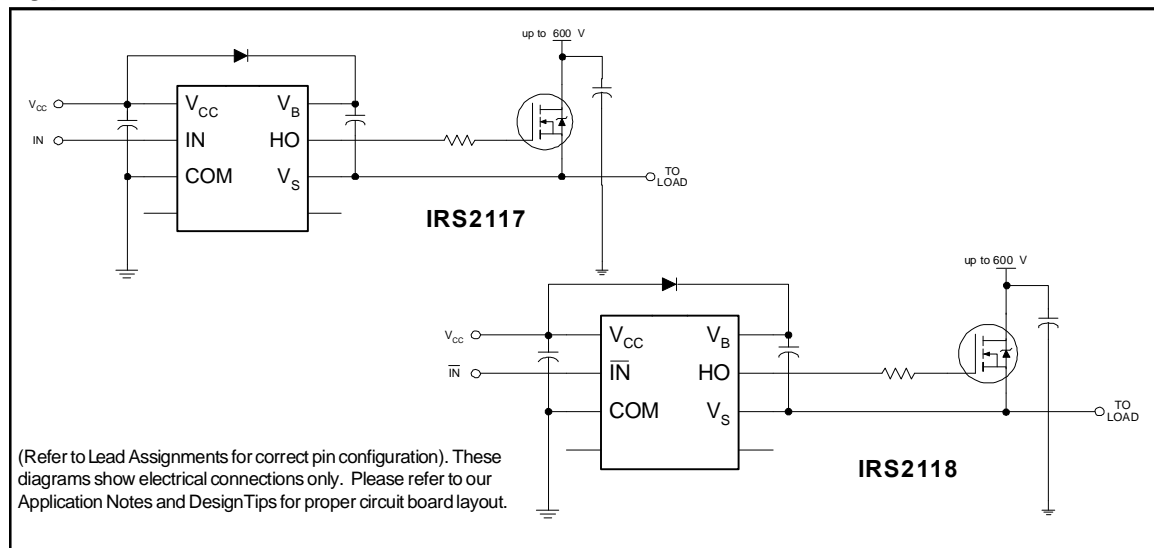

Absolute Maximum Ratings

Absolute maximum ratings indicate sustained limits beyond which damage to the device may occur. All voltage parameters are absolute voltages referenced to COM. The thermal resistance and power dissipation ratings are measured under board mounted and still air conditions. Additional information is shown in Figs. 5 through 8.

Symbol	Definition	Min.	Max.	Units	
V _B	High-side floating supply voltage	-0.3	625	V	
V _S	High-side floating supply offset voltage	V _B - 25	V _B + 0.3		
V _{HO}	High-side floating output voltage	V _S - 0.3	V _B + 0.3		
V _{CC}	Logic supply voltage	-0.3	25		
V _{IN}	Logic input voltage	-0.3	V _{CC} + 0.3		
dV _S /dt	Allowable offset supply voltage transient (Fig. 2)	—	50	V/ns	
P _D	Package power dissipation @ T _A ≤ +25 °C	(8 lead PDIP)	—	1.0	W
		(8 lead SOIC)	—	0.625	
R _{thJA}	Thermal resistance, junction to ambient	(8 lead PDIP)	—	125	°C/W
		(8 lead SOIC)	—	200	
T _J	Junction temperature	—	150	°C	
T _S	Storage temperature	-55	150		
T _L	Lead temperature (soldering, 10 seconds)	—	300		

Recommended Operating Conditions

The input/output logic timing diagram is shown in Fig. 1. For proper operation the device should be used within the recommended conditions. The V_S offset rating is tested with all supplies biased at 15 V differential.

Symbol	Definition	Min.	Max.	Units
V _B	High-side floating supply absolute voltage	V _S + 10	V _S + 20	V
V _S	High-side floating supply offset voltage	Note 1	600	
V _{HO}	High-side floating output voltage	V _S	V _B	
V _{CC}	Logic supply voltage	10	20	
V _{IN}	Logic input voltage	0	V _{CC}	
T _A	Ambient temperature	-40	125	°C

Note 1: Logic operational for V_S of -5 V to +600 V. Logic state held for V_S of -5 V to -V_{BS}. (Please refer to the Design Tip DT97-3 for more details).

Dynamic Electrical Characteristics

V_{BIAS} (V_{CC} , V_{BS}) = 15 V, C_L = 1000 pF and T_A = 25 °C unless otherwise specified. The dynamic electrical characteristics are measured using the test circuit shown in Fig. 3.

Symbol	Definition	Min.	Typ.	Max.	Units	Test Conditions
t_{on}	Turn-on propagation delay	—	125	200	ns	$V_S = 0$ V
t_{off}	Turn-off propagation delay	—	105	180		$V_S = 600$ V
t_r	Turn-on rise time	—	75	130		
t_f	Turn-off fall time	—	35	65		

Static Electrical Characteristics

V_{BIAS} (V_{CC} , V_{BS}) = 15 V and T_A = 25 °C unless otherwise specified. The V_{IN} , V_{TH} , and I_{IN} parameters are referenced to COM. The V_O and I_O parameters are referenced to COM and are applicable to the respective output leads: HO or LO.

Symbol	Definition	Min.	Typ.	Max.	Units	Test Conditions
V_{IH}	Input voltage - logic "1" (IRS2117) logic "0" (IRS2118)	9.5	—	—	V	$I_O = 2$ mA
V_{IL}	Input voltage - logic "0" (IRS2117) logic "1" (IRS2118)	—	—	6.0		
V_{OH}	High level output voltage, $V_{BIAS} - V_O$	—	0.05	0.2		
V_{OL}	Low level output voltage, V_O	—	0.02	0.1		
I_{LK}	Offset supply leakage current	—	—	50	μA	$V_B = V_S = 600$ V
I_{QBS}	Quiescent V_{BS} supply current	—	50	240		$V_{IN} = 0$ V or V_{CC}
I_{QCC}	Quiescent V_{CC} Supply Current	—	70	340		$V_{IN} = V_{CC}$
I_{IN+}	Logic "1" input bias current	(IRS2117) — (IRS2118)	20	40		$V_{IN} = 0$ V
I_{IN-}	Logic "0" input bias current	(IRS2117) — (IRS2118)	—	5.0	$V_{IN} = V_{CC}$	
V_{BSUV+}	V_{BS} supply undervoltage positive going threshold	7.6	8.6	9.6	V	
V_{BSUV-}	V_{BS} supply undervoltage negative going threshold	7.2	8.2	9.2		
V_{CCUV+}	V_{CC} supply undervoltage positive going threshold	7.6	8.6	9.6		
V_{CCUV-}	V_{CC} supply undervoltage negative going threshold	7.2	8.2	9.2		
I_{O+}	Output high short circuit pulsed current	200	290	—	mA	$V_O = 0$ V $V_{IN} = \text{Logic "1"}$ $PW \leq 10$ μs
I_{O-}	Output low short circuit pulsed current	420	600	—		$V_O = 15$ V $V_{IN} = \text{Logic "0"}$ $PW \leq 10$ μs

Functional Block Diagram (IRS2117)

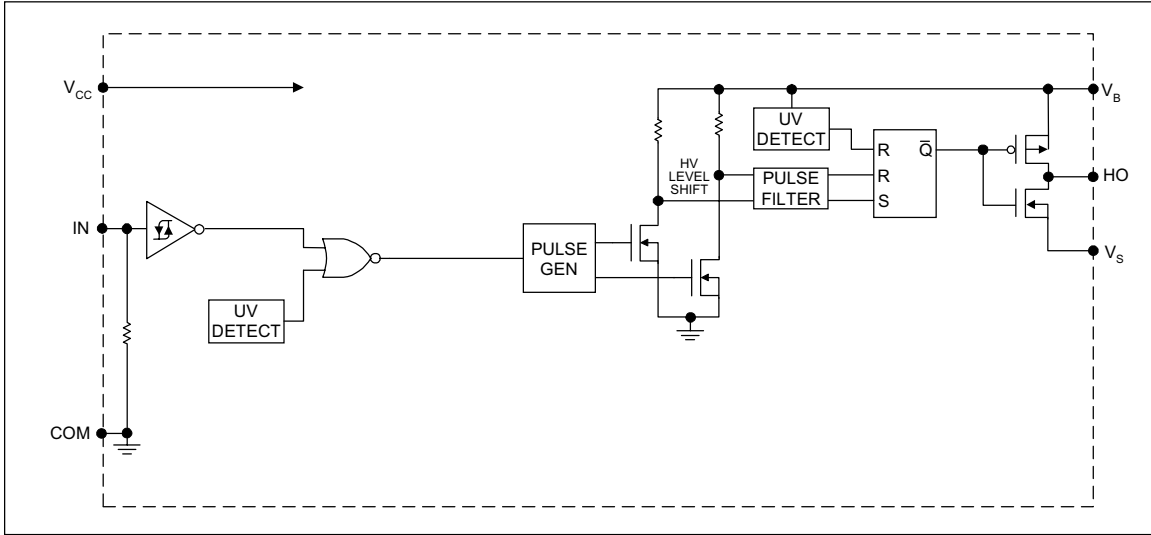

Functional Block Diagram (IRS2118)

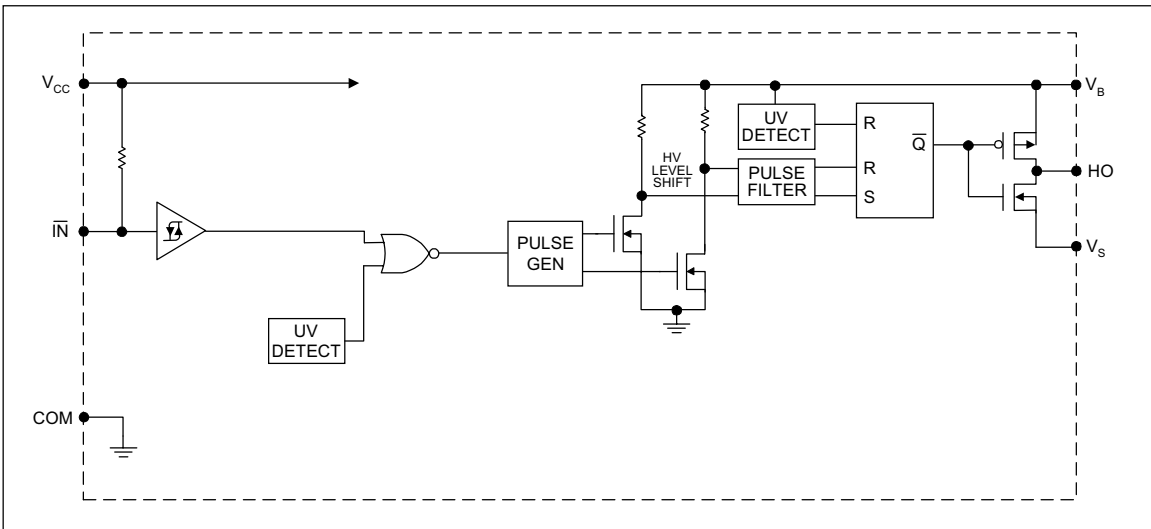

Lead Definitions

Symbol	Description
V _{CC}	Logic and gate drive supply
IN	Logic input for gate driver output (HO), in phase with HO (IRS2117)
$\overline{\text{IN}}$	Logic input for gate driver output (HO), out of phase with HO (IRS2118)
COM	Logic ground
V _B	High-side floating supply
HO	High-side gate drive output
V _S	High-side floating supply return

Lead Assignments

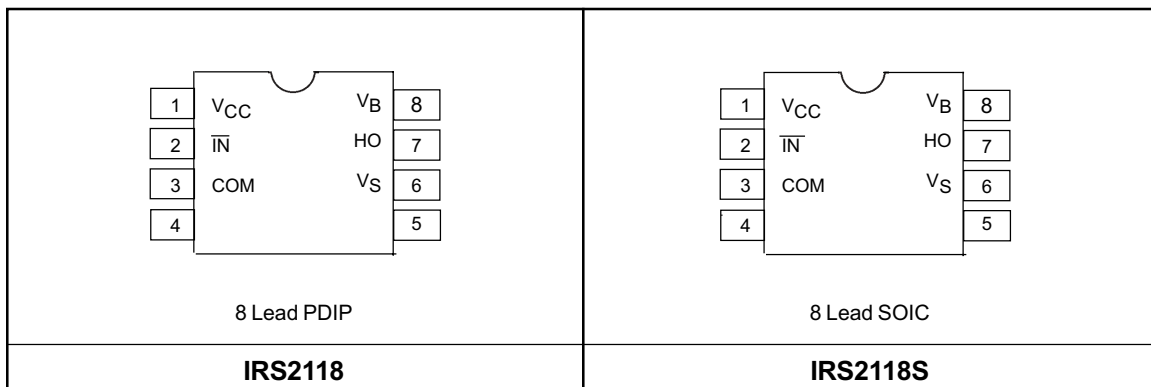
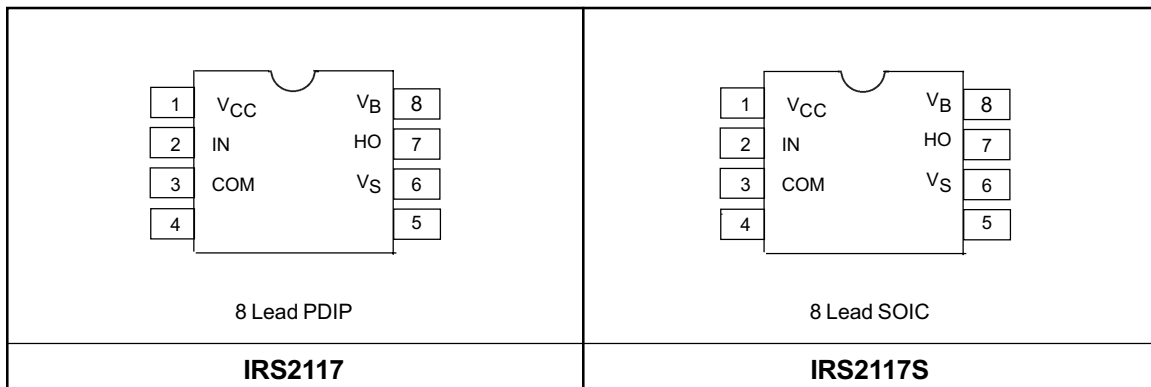

IRS2117/IRS2118(S)PbF

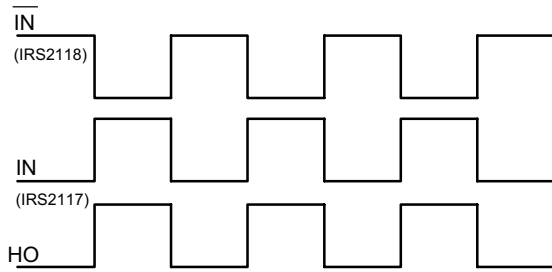

Figure 1. Input/Output Timing Diagram

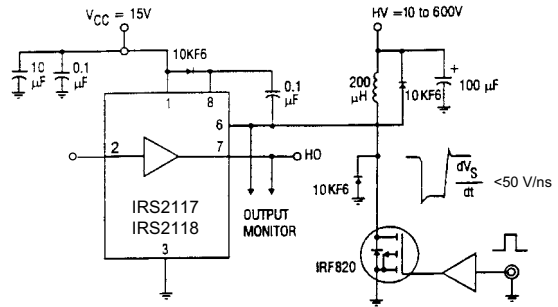

Figure 2. Floating Supply Voltage Transient Test Circuit

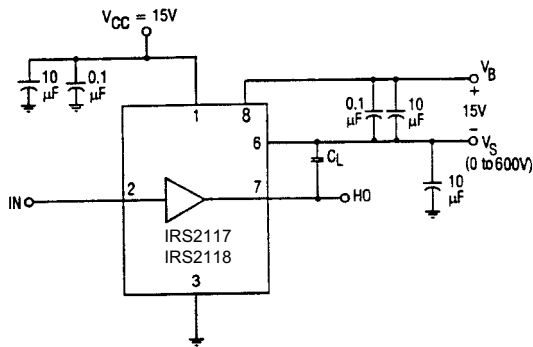

Figure 3. Switching Time Test Circuit

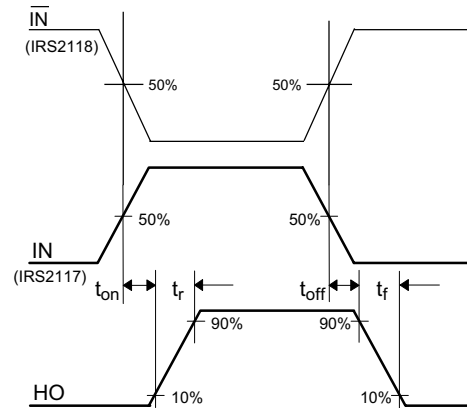

Figure 4. Switching Time Waveform Definition

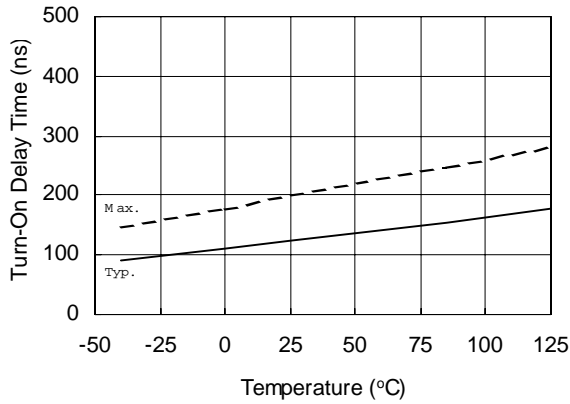

Figure 5A. Turn-On Time vs. Temperature

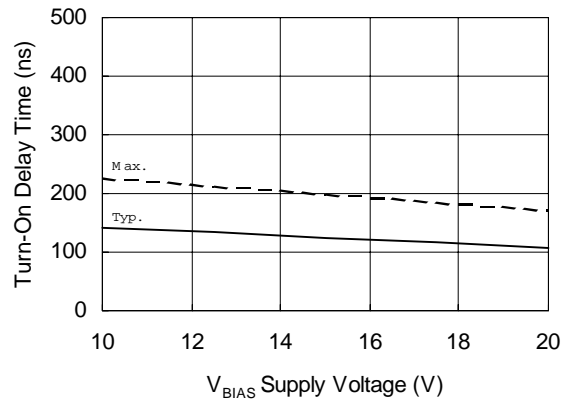

Figure 5B. Turn-On Time vs. Supply Voltage

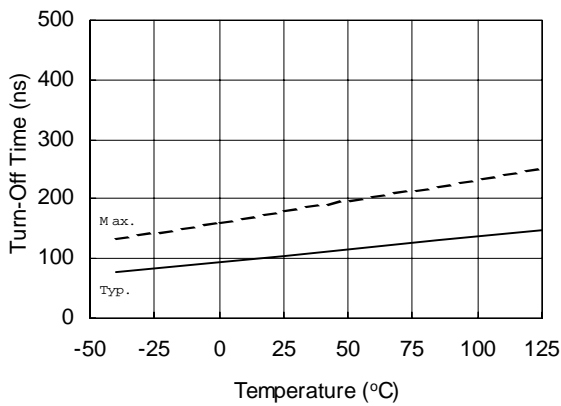

Figure 6A. Turn-Off Time vs. Temperature

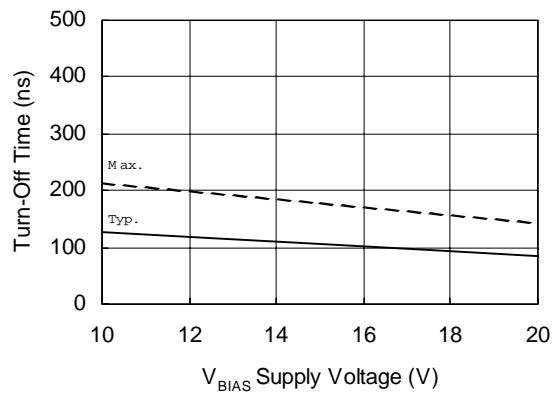

Figure 6B. Turn-Off Time vs. Supply Voltage

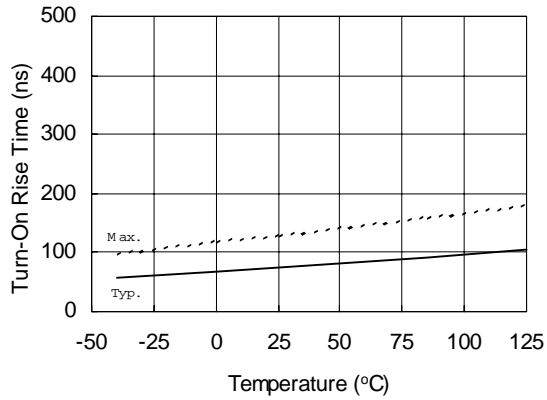

Figure 7A. Turn-On Rise Time vs. Temperature

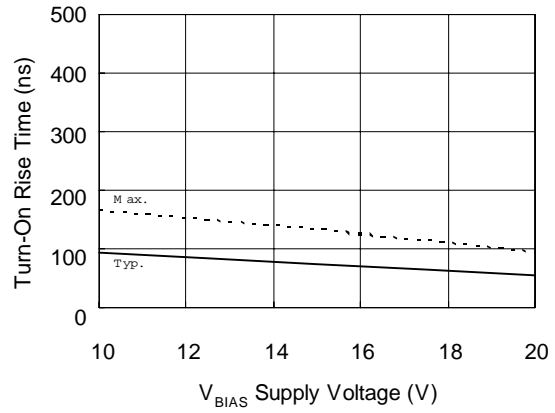

Figure 7B. Turn-On Rise Time vs. Supply Voltage

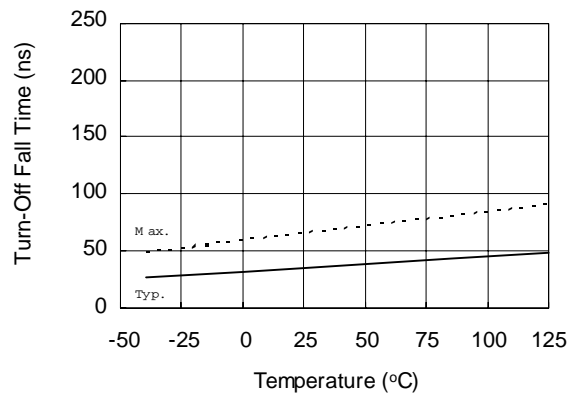

Figure 8A. Turn-Off Fall Time vs. Temperature

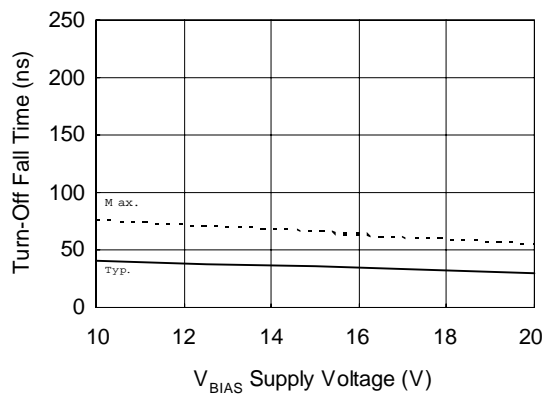

Figure 8B. Turn-Off Fall Time vs. Supply Voltage

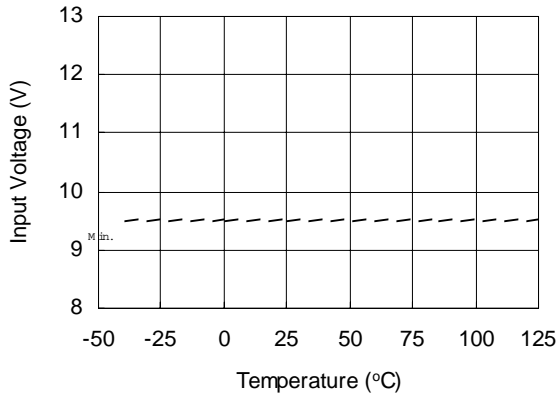

Figure 9A. Logic "1" (IRS2118 "0") Input Voltage vs. Temperature

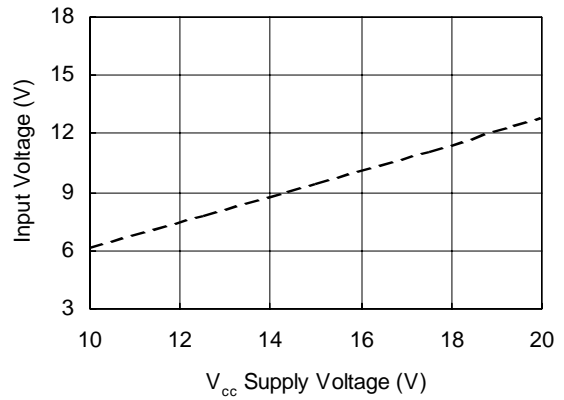

Figure 9B. Logic "1" (IRS2118 "0") Input Voltage vs. Supply Voltage

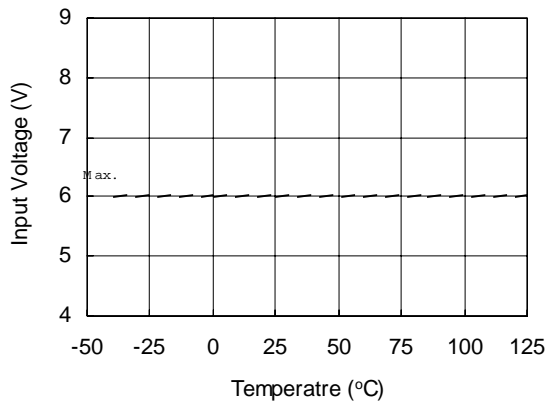

Figure 10A. Logic "0" (IRS2118 "1") Input Voltage vs. Temperature

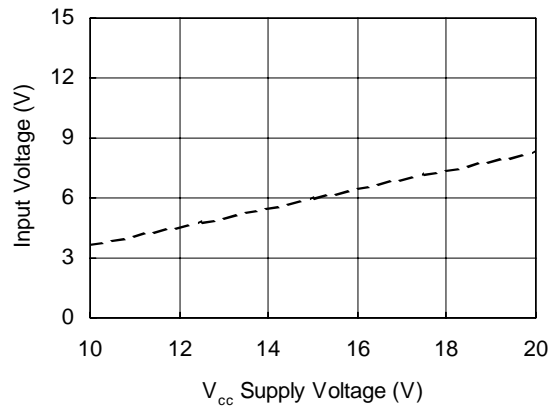

Figure 10B. Logic "0" (IRS2118 "1") Input Voltage vs. Supply Voltage

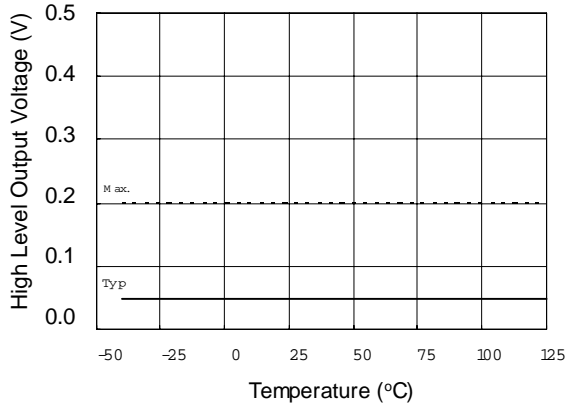

Figure 11A. High Level Output vs. Temperature ($I_o = 2\text{ mA}$)

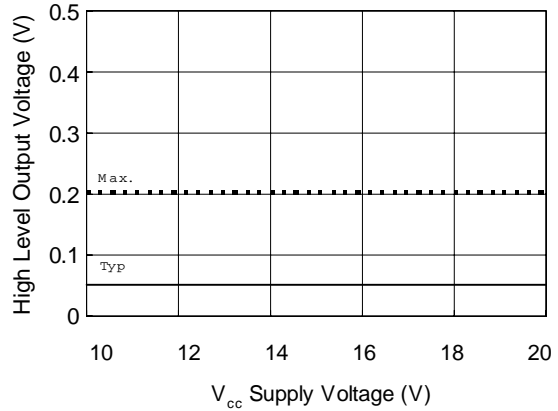

Figure 11B. High Level Output vs. Supply Voltage ($I_o = 2\text{ mA}$)

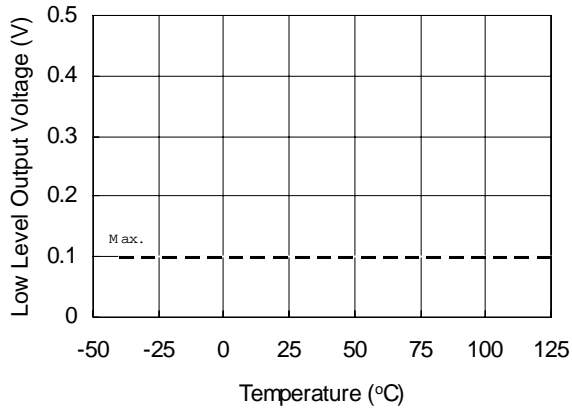

Figure 12A. Low Level Output vs. Temperature

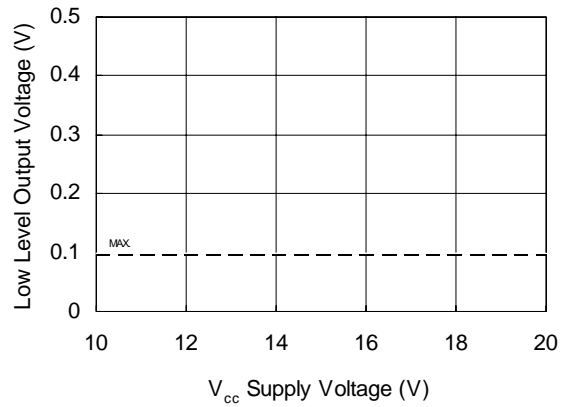

Figure 12B. Low Level Output vs. Supply Voltage

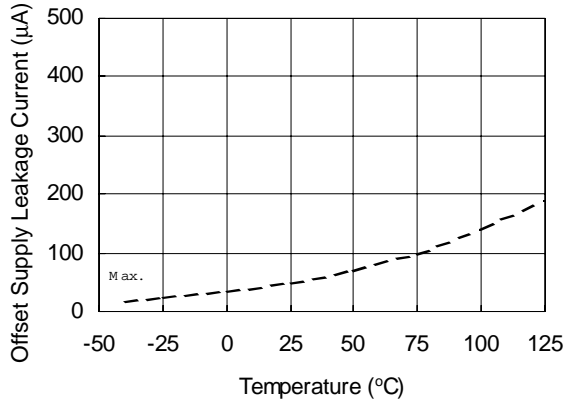

Figure 13A. Offset Supply Leakage Current vs. Temperature

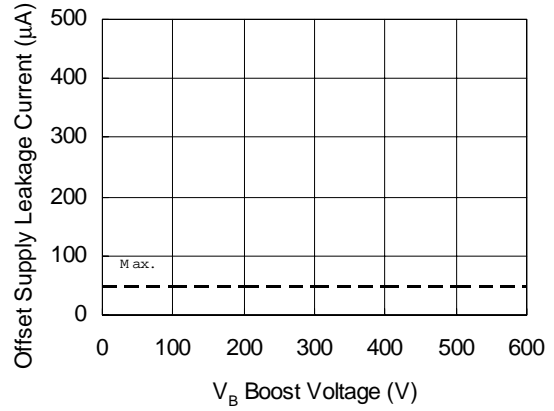

Figure 13B. Offset Supply Leakage Current vs. V_B Boost Voltage

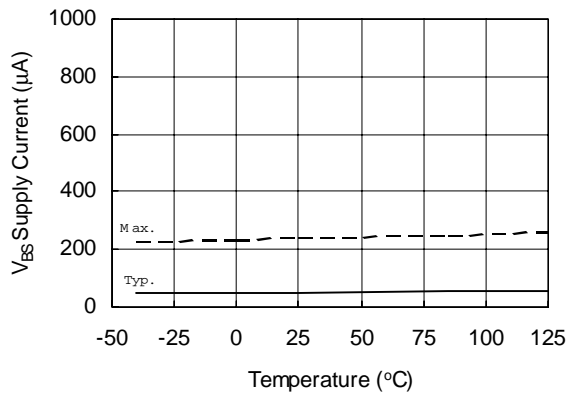

Figure 14A. V_{BS} Supply Current vs. Temperature

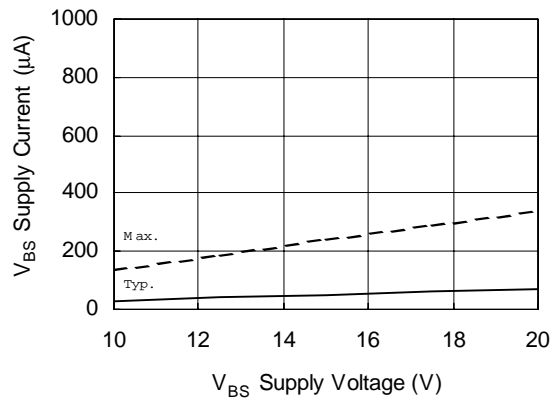

Figure 14B. V_{BS} Supply Current vs. Supply Voltage

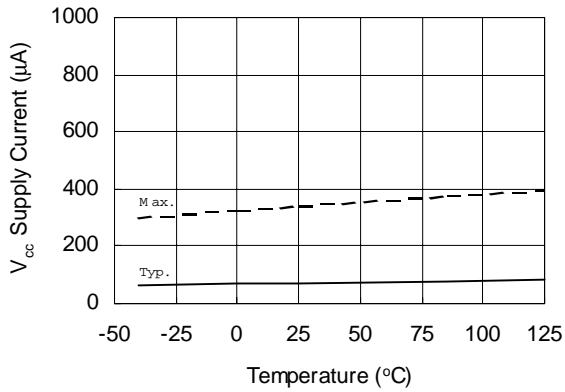

Figure 15A. V_{CC} Supply Current vs. Temperature

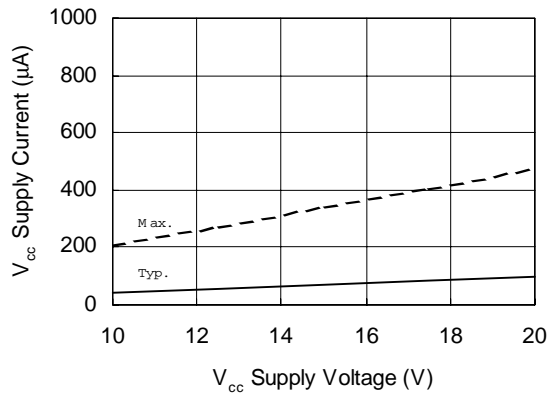

Figure 15B. V_{CC} Supply Current vs. Supply Voltage

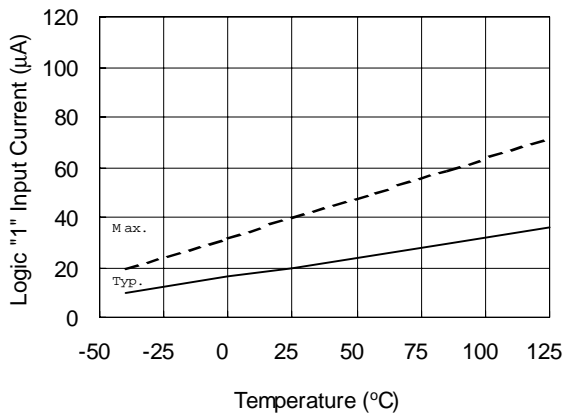

Figure 16A. Logic "1" (IRS2118 Logic "0") Input Current vs. Temperature

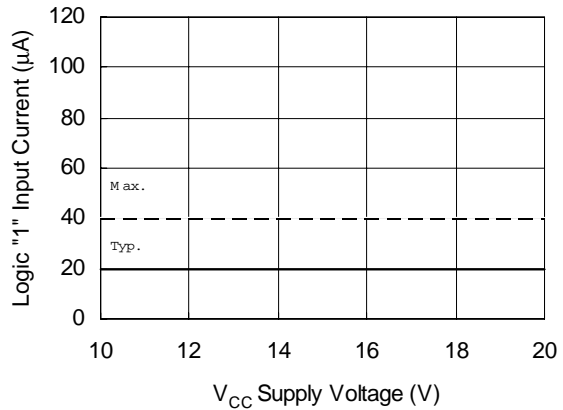

Figure 16B. Logic "1" (IRS2118 Logic "0") Input Current vs. Supply Voltage

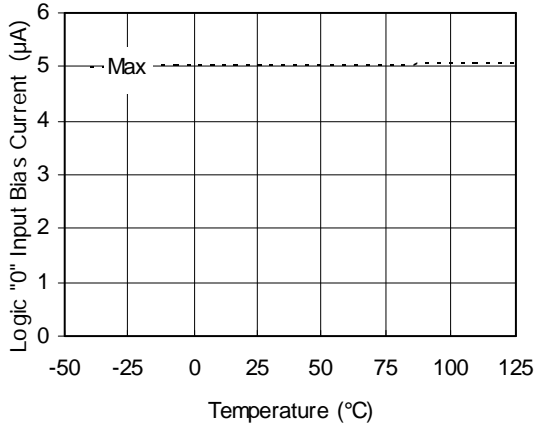

Figure 17A. Logic "0" Input Bias Current vs. Temperature

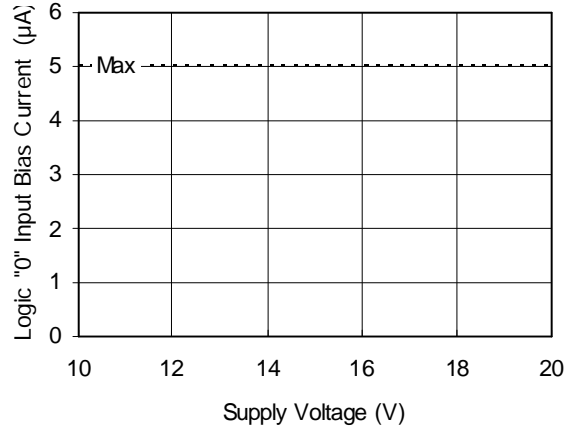

Figure 17B. Logic "0" Input Bias Current vs. Voltage

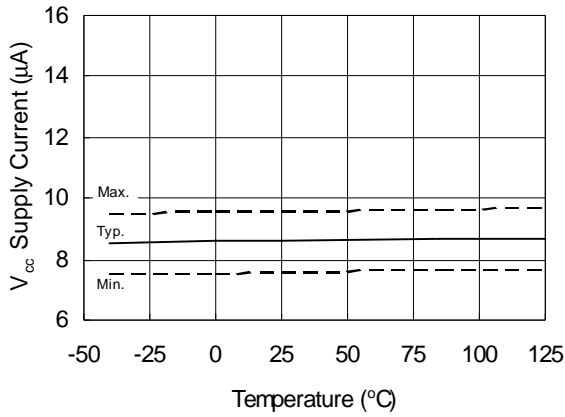

Figure 18. V_{cc} Undervoltage Threshold (+) vs. Temperature

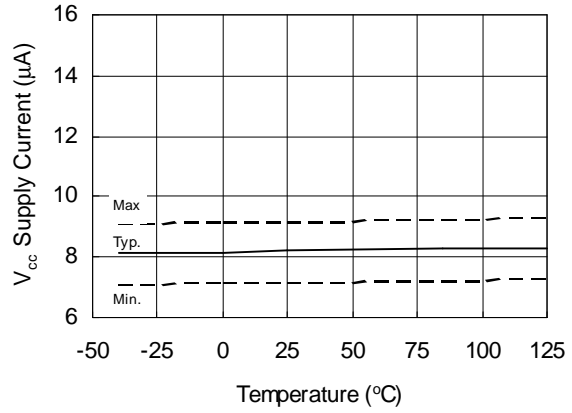

Figure 19. V_{cc} Undervoltage Threshold (-) vs. Temperature

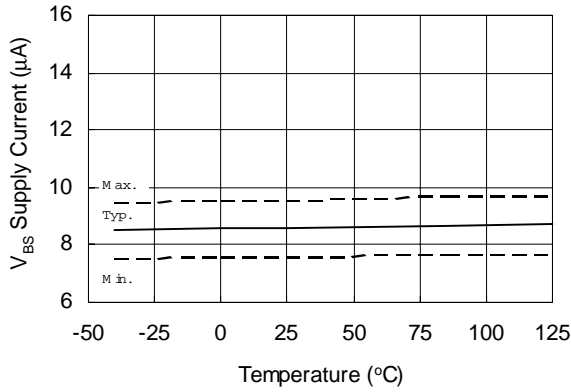

Figure 20. V_{BS} Undervoltage Threshold (+) vs. Temperature

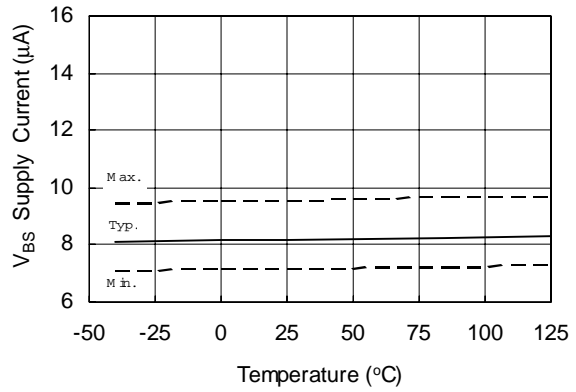

Figure 21. V_{BS} Undervoltage Threshold (-) vs. Temperature

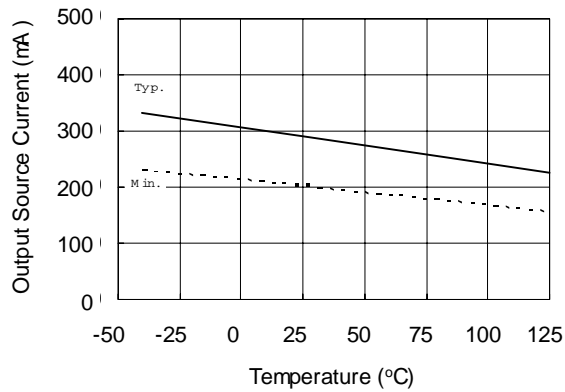

Figure 22A. Output Source Current vs. Temperature

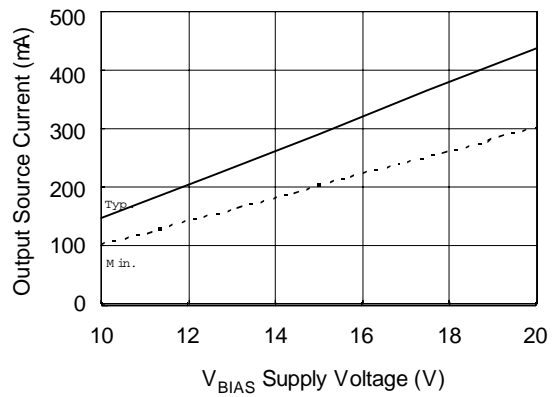

Figure 22B. Output Source Current vs. Supply Voltage

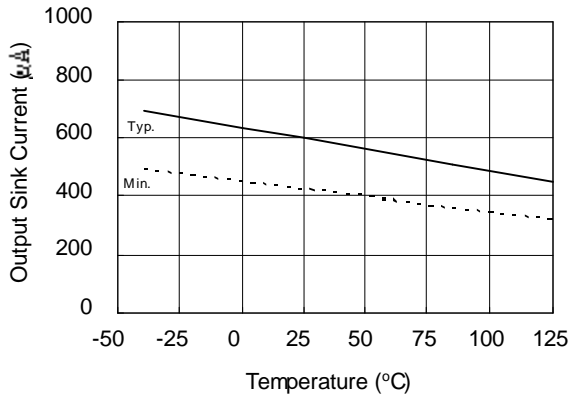

Figure 23A. Output Sink Current vs. Temperature

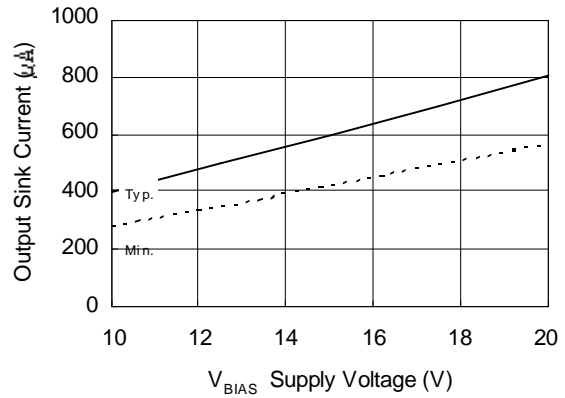

Figure 23B. Output Sink Current vs. Supply Voltage

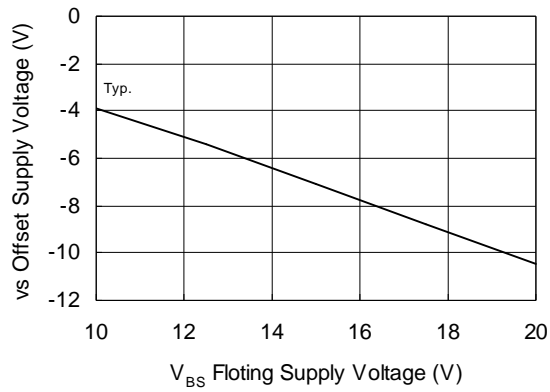

Figure 24. Maximum VS Negative Offset vs. Supply Voltage

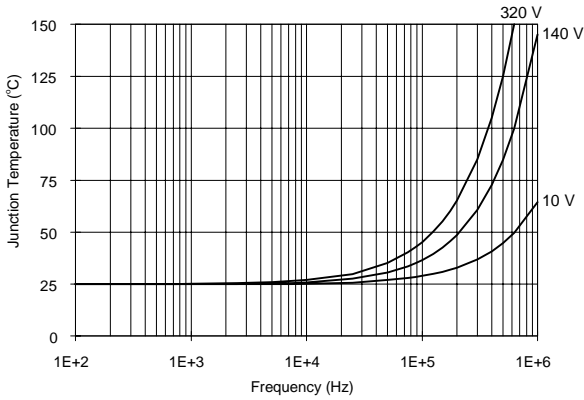

Figure 24. IRS2117/IRS2118 T_J vs. Frequency (IRFBC20)
R_{GATE} = 33 Ω, V_{CC} = 15 V

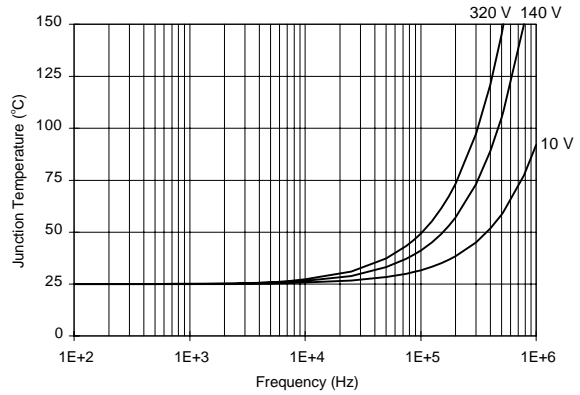

Figure 25. IRS2117/IRS2118 T_J vs. Frequency (IRFBC30)
R_{GATE} = 22 Ω, V_{CC} = 15 V

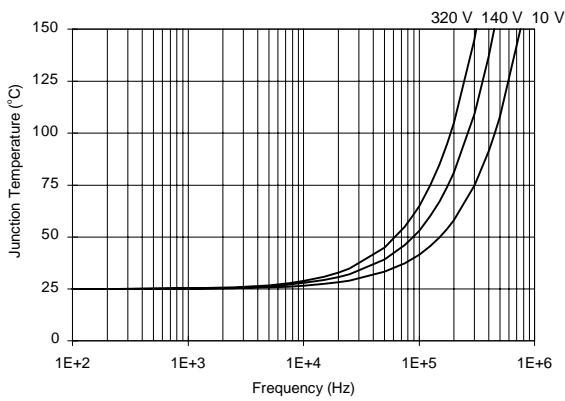

Figure 26. IRS2117/IRS2118 T_J vs. Frequency (IRFBC40)
R_{GATE} = 15 Ω, V_{CC} = 15 V

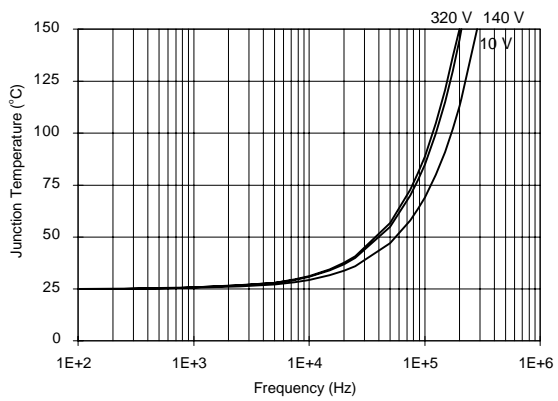
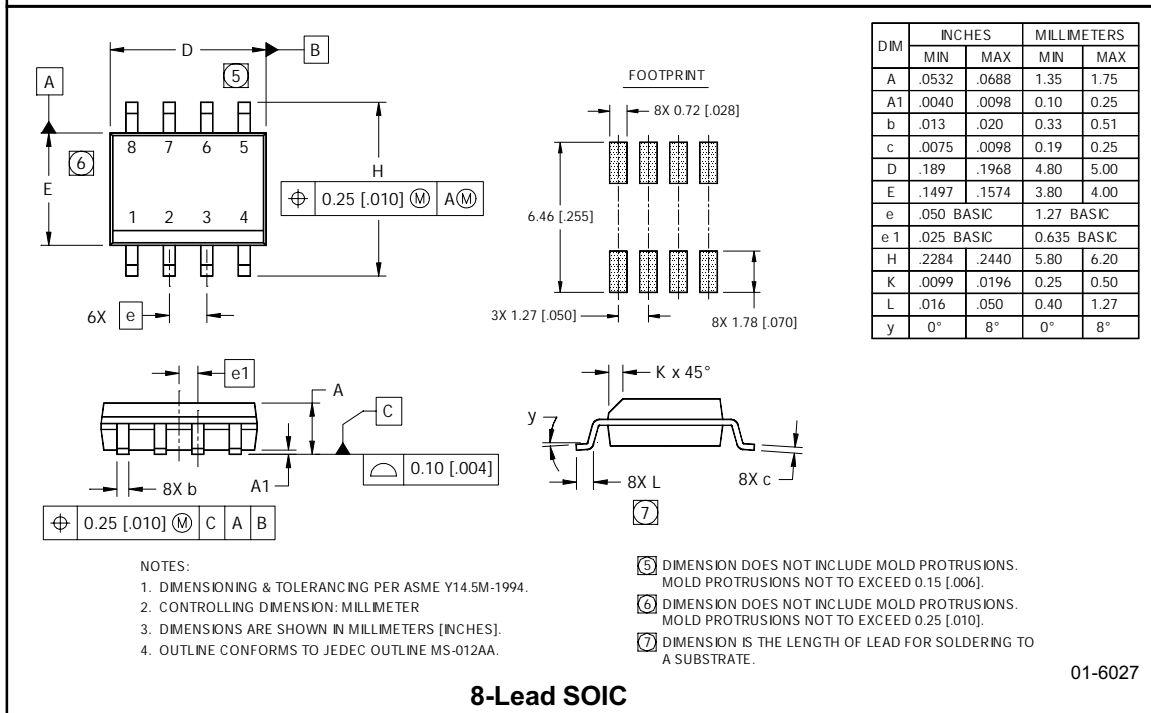
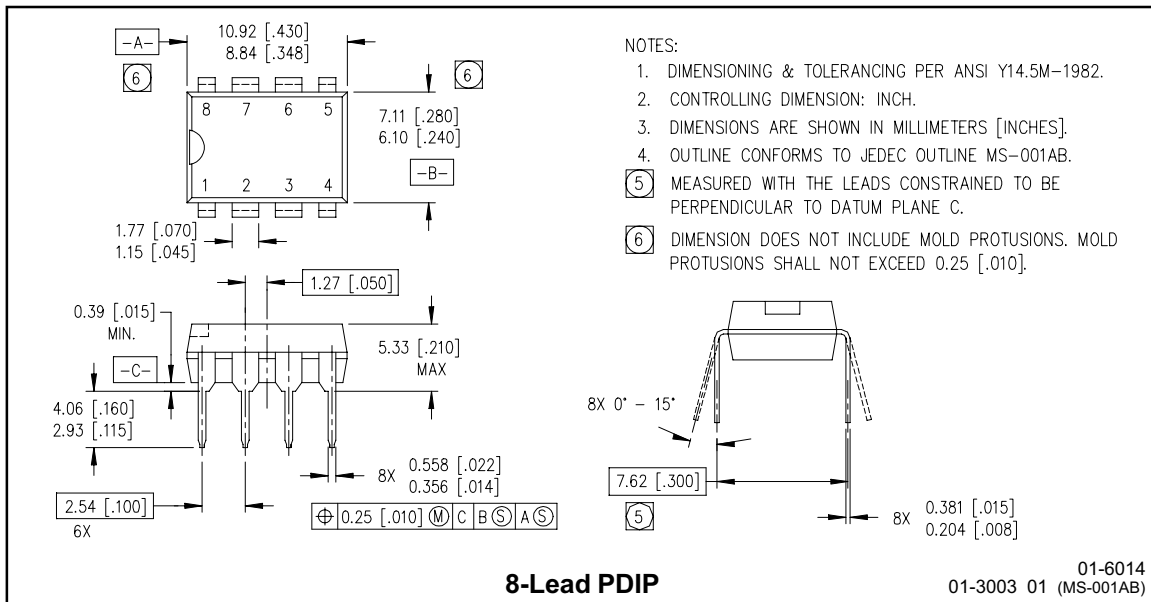
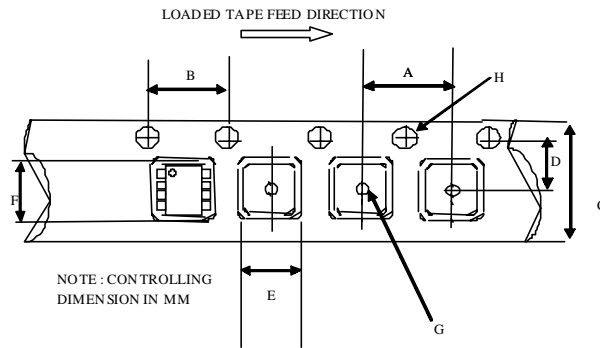

Figure 27. IRS2117/IRS2118 T_J vs. Frequency (IRFPE50)
R_{GATE} = 10 Ω, V_{CC} = 15 V

Case outlines



**Tape & Reel
8-Lead SOIC**



CARRIER TAPE DIMENSION FOR 8SOICN

Code	Metric		Imperial	
	Min	Max	Min	Max
A	7.90	8.10	0.311	0.318
B	3.90	4.10	0.153	0.161
C	11.70	12.30	0.46	0.484
D	5.45	5.55	0.214	0.218
E	6.30	6.50	0.248	0.255
F	5.10	5.30	0.200	0.208
G	1.50	n/a	0.059	n/a
H	1.50	1.60	0.059	0.062

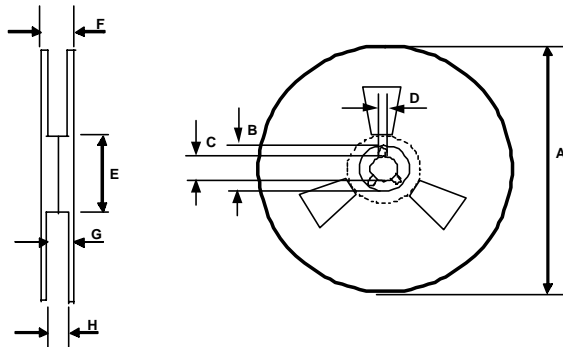

REEL DIMENSIONS FOR 8SOICN

Code	Metric		Imperial	
	Min	Max	Min	Max
A	329.60	330.25	12.976	13.001
B	20.95	21.45	0.824	0.844
C	12.80	13.20	0.503	0.519
D	1.95	2.45	0.767	0.096
E	98.00	102.00	3.858	4.015
F	n/a	18.40	n/a	0.724
G	14.50	17.10	0.570	0.673
H	12.40	14.40	0.488	0.566

LEADFREE PART MARKING INFORMATION

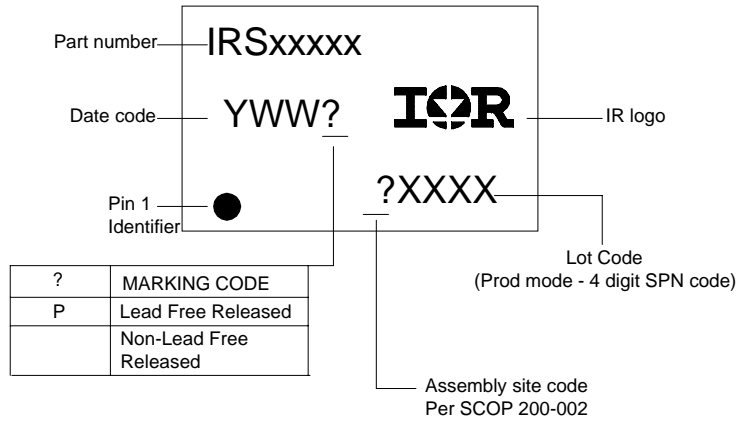

ORDER INFORMATION

- 8-LeadPDIP IRS2117PbF
- 8-LeadPDIP IRS2118PbF
- 8-LeadSOIC IRS2117SPbF
- 8-LeadSOIC IRS2118SPbF
- 8-Lead SOIC Tape & Reel IRS2117STRPbF
- 8-Lead SOIC Tape & Reel IRS2118STRPbF