

### Features

- Plastic package has Underwriters Laboratory Flammability Classification 94V-0
- Low forward voltage drop
- High current capability
- High reliability
- Low power loss, high efficiency
- High surge current capability
- High speed switching
- Low leakage

### TO-220A

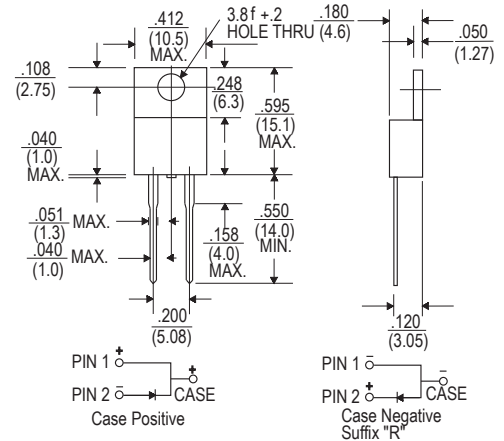

Dimensions in inches and (millimeters)

### Mechanical Data

- Case : JEDEC TO-220A molded plastic body
- Terminals : Lead solderable per MIL-STD-750, method 2026
- Polarity : As marked
- Mounting Position : Any
- Weight : 0.08 ounce, 2.24 gram

### Maximum Ratings And Electrical Characteristics

(Ratings at 25°C ambient temperature unless otherwise specified, Single phase, half wave 60Hz, resistive or inductive load. For capacitive load, derate by 20%)

	Symbols	HER 1601	HER 1602	HER 1603	HER 1604	HER 1605	HER 1606	Units
Maximum recurrent peak reverse voltage	V <sub>RRM</sub>	50	100	200	300	400	600	Volts
Maximum RMS voltage	V <sub>RMS</sub>	35	70	140	210	280	420	Volts
Maximum DC blocking voltage	V <sub>DC</sub>	50	100	200	300	400	600	Volts
Maximum average forward rectified current 0.375"(9.5mm) lead length @ at T <sub>A</sub> =100°C	I <sub(av)< sub=""></sub(av)<>	16.0						Amps
Peak forward surge current 8.3ms single half sine-wave superimposed on rated load (JEDEC method)	I <sub>FSM</sub>	200						Amps
Maximum instantaneous forward voltage at 8.0A	V <sub>F</sub>	1.0			1.3	1.7	Volts	
Maximum DC reverse current at rated DC blocking voltage T <sub>A</sub> =25°C	I <sub>R</sub>	10.0						μA
Maximum DC reverse current at rated DC blocking voltage T <sub>A</sub> =125°C		100						
Maximum reverse recovery time (Note 1)	T <sub>rr</sub>	50				80	ns	
Typical junction capacitance (Note 2)	C <sub>J</sub>	80				50	pF	
Typical thermal resistance (Note 3)	R <sub>θJC</sub>	2.2						°C/W
Operating junction and storage temperature range	T <sub>J</sub> T <sub>STG</sub>	-55 to +150 -55 to +150						°C

### Notes:

- (1) Test conditions: I<sub>F</sub>=0.5A, I<sub>R</sub>=1.0A, I<sub>rr</sub>=0.25A.
- (2) Measured at 1MHz and applied reverse voltage of 4.0 Volts.
- (3) Thermal resistance from junction to case mounting on heatsink.

## RATINGS AND CHARACTERISTIC CURVES HER1601 THRU HER1606

FIG. 1 - REVERSE RECOVERY TIME CHARACTERISTIC AND TEST CIRCUIT DIAGRAM

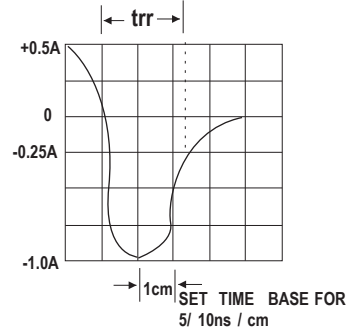
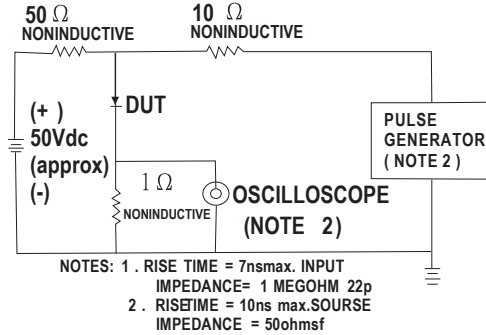

FIG. 2 - MAXIMUM AVERAGE FORWARD CURRENT DERATING

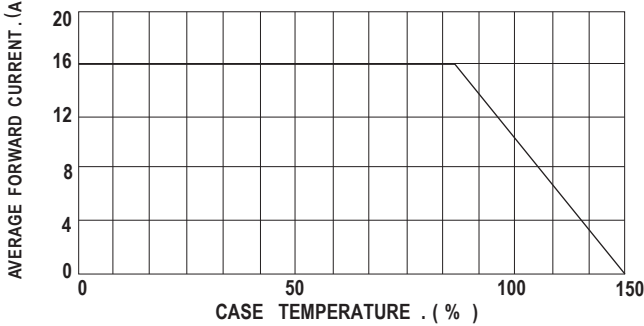

FIG. 3 - TYPICAL REVERSE CHARACTERISTICS

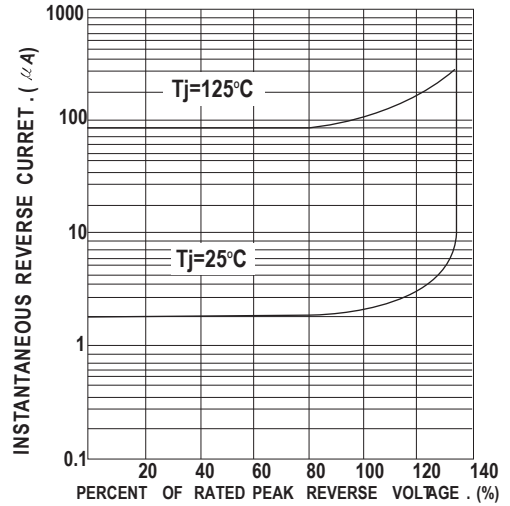

FIG. 4 - MAXIMUM NON-REPETITIVE FORWARD SURGE CURRENT

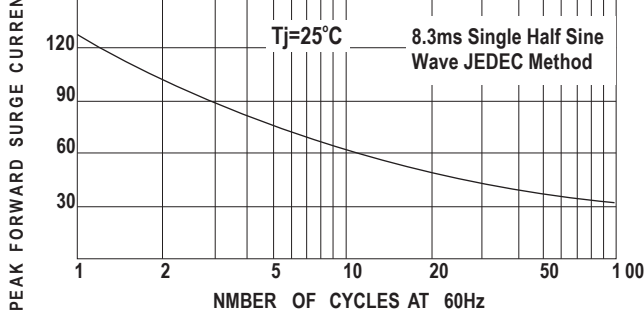

FIG. 6 - TYPICAL FORWARD CHARACTERISTICS

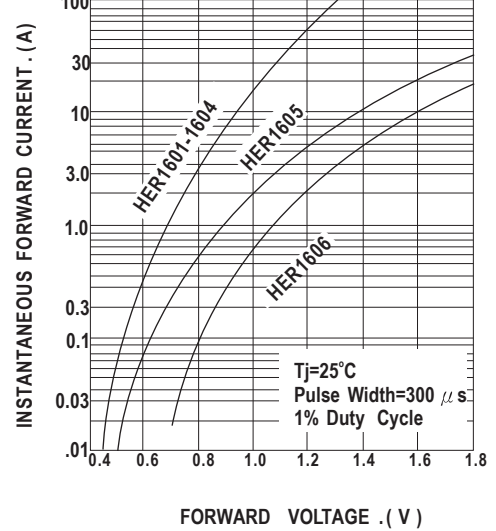

FIG. 5 - TYPICAL JUNCTION CAPACITANCE PER LEG

