



AKD4342-B

AK4342 Evaluation board Rev.2

GENERAL DESCRIPTION

AKD4342-B is an evaluation board for 24bit DAC with built-in 2Vrms lineout, headphone, and Aux lineout amplifiers, AK4342. The AKD4342-B has the interface with AKM's ADC evaluation boards. Therefore, it's easy to evaluate the AK4342. The AKD4342-B also has the digital audio interface and can achieve the interface with digital audio systems via opt-connector.

■ Ordering guide

AKD4342-B --- Evaluation board for AK4342
 (Cable for connecting with printer port of IBM-AT compatible PC and control software are packed with this. This control software does not operate on Windows NT.)

FUNCTION

- **Compatible with 2 types of interface**
 - Direct interface with AKM's A/D converter evaluation boards
 - On-board AK4113 as DIR which accepts optical input

- **10pin header for serial control interface**

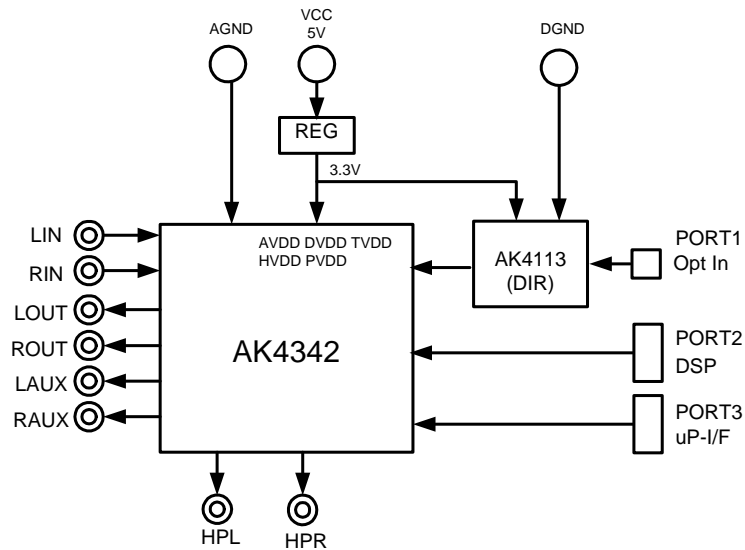

Figure 1.. AKD4342-B Block Diagram

* Circuit diagram and PCB layout are attached at the end of this manual.

Evaluation Board Manual

■ Operation sequence

1) Set up the power supply lines.

[VCC]	(red)	= 5V
[AGND]	(black)	= 0V
[DGND]	(black)	= 0V

Each supply line should be distributed from the power supply unit.
The power is supplied from VCC jack to the AK4342 via the regulator.

2) Set up the evaluation mode, jumper pins. (See the followings.)

3) Power on.

The AK4342 and AK4113 should be resets once bringing SW1 “L” upon power-up.

■ Evaluation mode

Applicable Evaluation Mode

(1) In case of using DIR (Optical Link) <default>

It is possible to use the initial setting of the audio interface format (24bit MSB justified) to evaluate the AK4342.

(2) In case of connecting AK4342 with a external DSP

(1) In case of using DIR (Optical Link) <default>

PORT1 is used. DIR generates MCLK, BICK, LRCK and SDATA from the received data through optical connector (TORX141). Nothing should be connected to PORT2 (DSP).

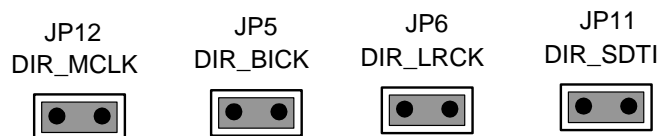

(2) In case of connecting AK4342 with an external DSP

AKD4342-B can be connected with an external DSP through PORT2 (DSP). MCLK, BICK, LRCK and SDATA are supplied from DSP.

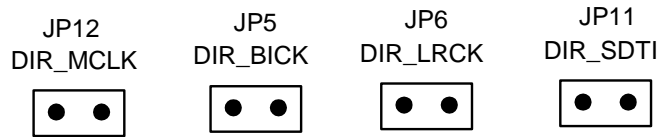

■ Other jumper pins set up

JP3 (GND): Analog ground and Digital ground.

OPEN : Separated. <Default>

SHORT : Common. (The connector "DGND" can be open.)

■ The function of the toggle SW

Upper-side is "H" and lower-side is "L".

[SW1] (DAC/DIR_PDN) : Resets the AK4342 and AK4113. Keep "H" during normal operation.

■ Indication for LED

[LED1] (INT0) : Monitor INT0 pin of the AK4113.

■ **Serial Control**

The AK4342-B can be controlled via the printer port (parallel port) of IBM-AT compatible PC. Connect PORT3 (uP-I/F) with PC by 10 wire flat cable packed with the AKD4342-B. The packed control software only supports the 3-wire Serial Control Mode.

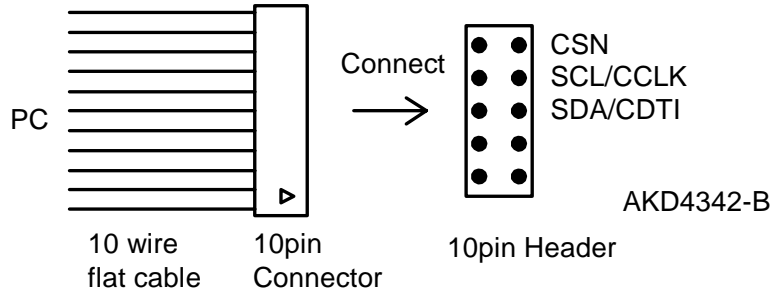
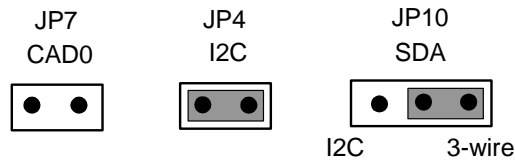

Figure 2. Connection of 10 wire flat cable

(1) 3-wire Serial Control Mode

The jumper pins should be set to the following.



(2) I²C-bus Control Mode

The jumper pins should be set to the following.

(2-1) Address bit: CAD0=0

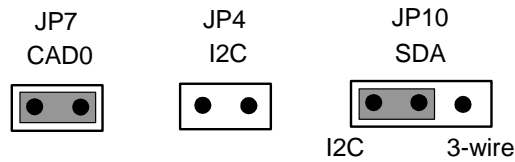

(2-2) Address Bit: CAD0=1

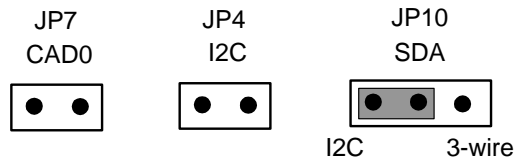

■ Input / Output circuits

(1) Input Circuit

LIN/RIN Input circuit

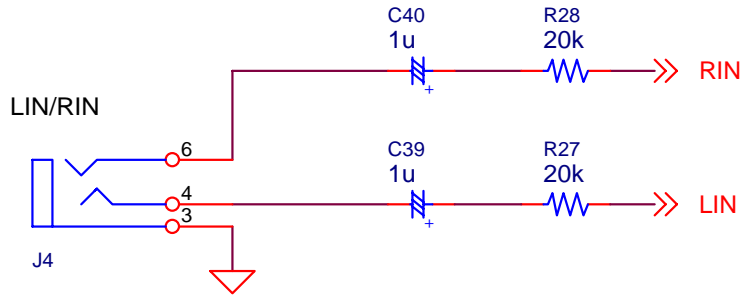

Figure 3. LIN/RIN Input circuit

(2) Output Circuit

(2-1) LOUT/ROUT Output circuit

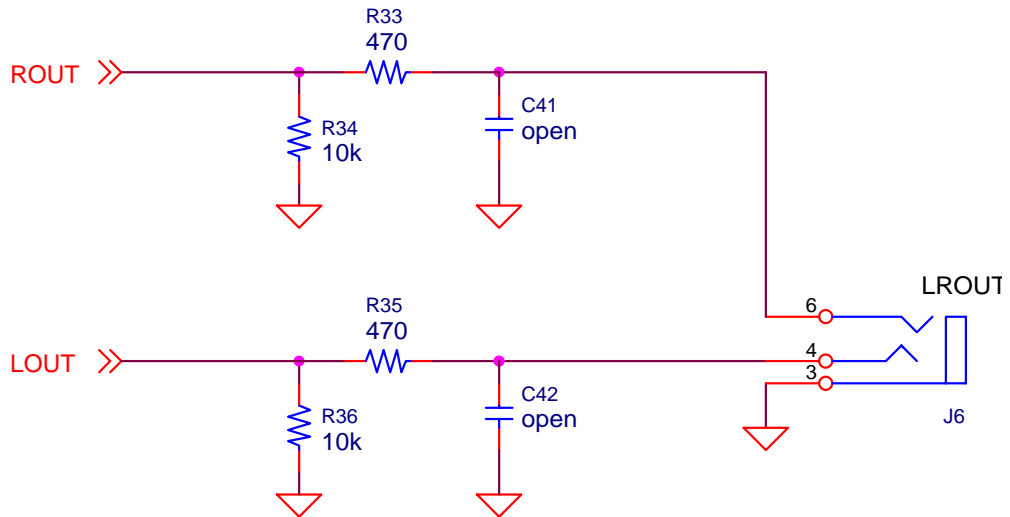

Figure 4. LOUT/ROUT Output circuit

(2-2) HPL/HPR Output circuit

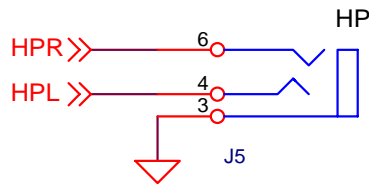

Figure 5. HPL/HPR Output circuit

(2-3) LAUX/RAUX Output circuit

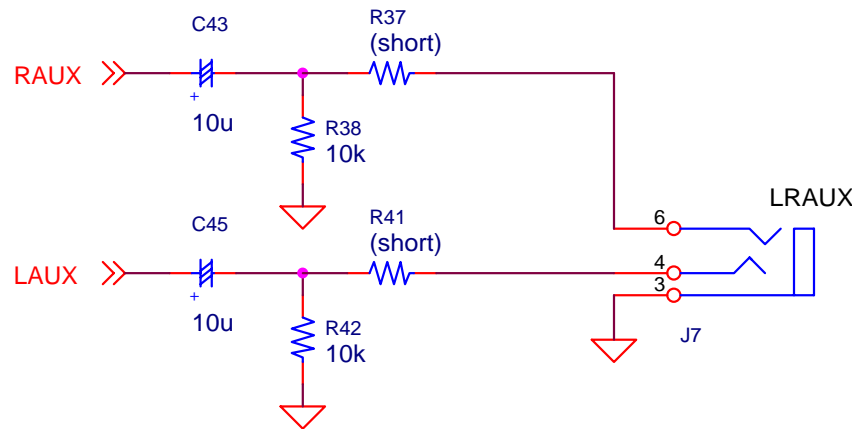

Figure 6. LAUX/RAUX Output circuit

* AKM assumes no responsibility for the trouble when using the circuit examples.

Control Software Manual

■ Set-up of evaluation board and control software

1. Set up the AKD4342-B according to previous term.
2. Connect IBM-AT compatible PC with AKD4342-B by 10-line type flat cable (packed with AKD4342-B). Take care of the direction of 10pin header. (Please install the driver in the CD-ROM when this control software is used on Windows 2000/XP. Please refer "Installation Manual of Control Software Driver by AKM device control software". In case of Windows95/98/ME, this installation is not needed. This control software does not operate on Windows NT.)
3. Insert the CD-ROM labeled "AK4342-B Evaluation Kit" into the CD-ROM drive.
4. Access the CD-ROM drive and double-click the icon of "akd4342-b.exe" to set up the control program.
5. Then please evaluate according to the follows.

■ Operation flow

Keep the following flow.

1. Set up the control program according to explanation above.
2. Click "Port Reset" button.
3. Click "Write default" button

■ Explanation of each buttons

1. [Port Reset] : Set up the USB interface board (AKDUSBIF-A) when using the board.
2. [Write default] : Initialize the register of the AK4342.
3. [All Write] : Write all registers that is currently displayed.
4. [Function1] : Dialog to write data by keyboard operation.
5. [Function2] : Dialog to write data by keyboard operation.
6. [Function3] : The sequence of register setting can be set and executed.
7. [Function4] : The sequence that is created on [Function3] can be assigned to buttons and executed.
8. [Function5] : The register setting that is created by [SAVE] function on main window can be assigned to buttons and executed.
9. [SAVE] : Save the current register setting.
10. [OPEN] : Write the saved values to all register.
11. [Write] : Dialog to write data by mouse operation.

■ Indication of data

Input data is indicated on the register map. Red letter indicates "H" or "1" and blue one indicates "L" or "0". Blank is the part that is not defined in the datasheet.

■ Explanation of each dialog

1. [Write Dialog]: Dialog to write data by mouse operation

There are dialogs corresponding to each register.

Click the [Write] button corresponding to each register to set up the dialog. If you check the check box, data becomes "H" or "1". If not, "L" or "0".

If you want to write the input data to the AK4342, click [OK] button. If not, click [Cancel] button.

2. [Function1 Dialog] : Dialog to write data by keyboard operation

Address Box: Input registers address in 2 figures of hexadecimal.

Data Box: Input registers data in 2 figures of hexadecimal.

If you want to write the input data to the AK4342, click [OK] button. If not, click [Cancel] button.

3. [Function2 Dialog] : Dialog to evaluate Volume

There are dialogs corresponding to register of 04h, 05h, 07h, 08h and 09h.

Address Box: Input registers address in 2 figures of hexadecimal.

Start Data Box: Input starts data in 2 figures of hexadecimal.

End Data Box: Input end data in 2 figures of hexadecimal.

Interval Box: Data is written to the AK4342 by this interval.

Step Box: Data changes by this step.

Mode Select Box:

If you check this check box, data reaches end data, and returns to start data.

[Example] Start Data = 00, End Data = 09

Data flow: 00 01 02 03 04 05 06 07 08 09 09 08 07 06 05 04 03 02 01 00

If you do not check this check box, data reaches end data, but does not return to start data.

[Example] Start Data = 00, End Data = 09

Data flow: 00 01 02 03 04 05 06 07 08 09

If you want to write the input data to the AK4342, click [OK] button. If not, click [Cancel] button.

4. [SAVE] and [OPEN]

4-1. [SAVE]

All of current register setting values displayed on the main window are saved to the file. The extension of file name is “akr”.

<Operation flow>

- (1) Click [SAVE] Button.
- (2) Set the file name and click [SAVE] Button. The extension of file name is “akr”.

4-2. [OPEN]

The register setting values saved by [SAVE] are written to the AK4342. The file type is the same as [SAVE].

<Operation flow>

- (1) Click [OPEN] Button.
- (2) Select the file (*.akr) and Click [OPEN] Button.

5. [Function3 Dialog]

The sequence of register setting can be set and executed.

(1) Click [F3] Button.

(2) Set the control sequence.

Set the address, Data and Interval time. Set “-1” to the address of the step where the sequence should be paused.

(3) Click [START] button. Then this sequence is executed.

The sequence is paused at the step of Interval="-1". Click [START] button, the sequence restarts from the paused step.

This sequence can be saved and opened by [SAVE] and [OPEN] button on the Function3 window. The extension of file name is “aks”.

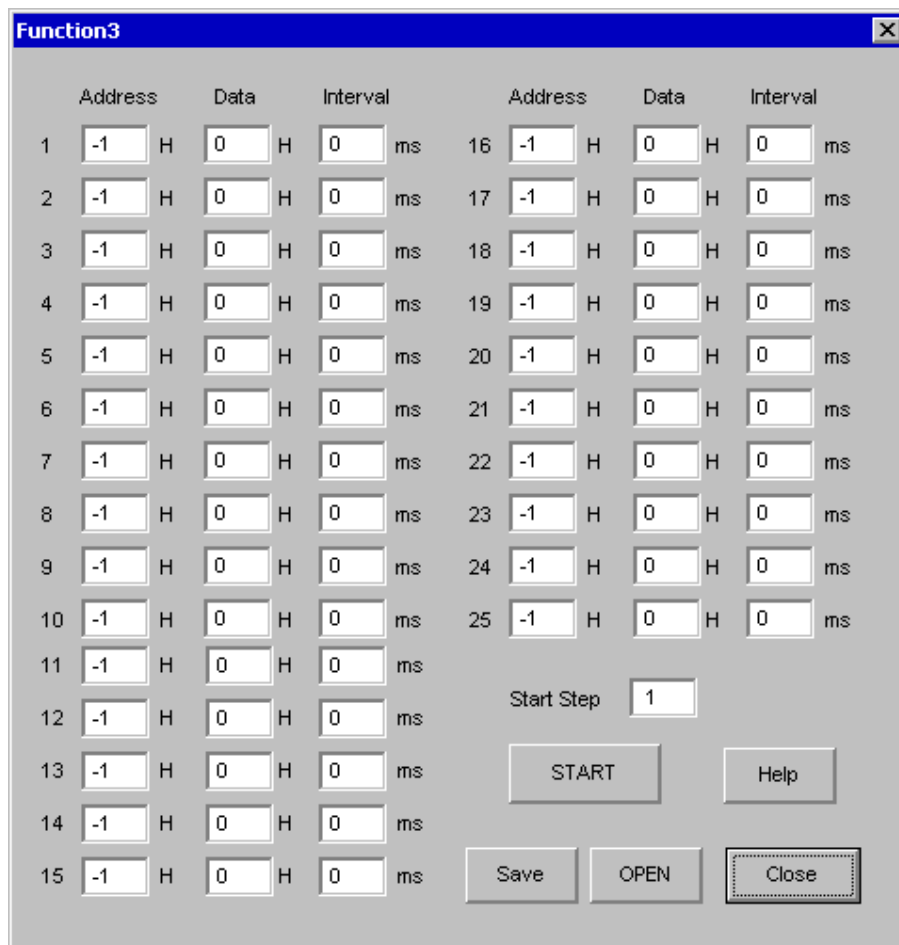

Figure 7. Window of [F3]

6. [Function4 Dialog]

The sequence file (*.aks) saved by [Function3] can be listed up to 10 files, assigned to buttons and then executed. When [F4] button is clicked, the window as shown in Figure 8 opens.

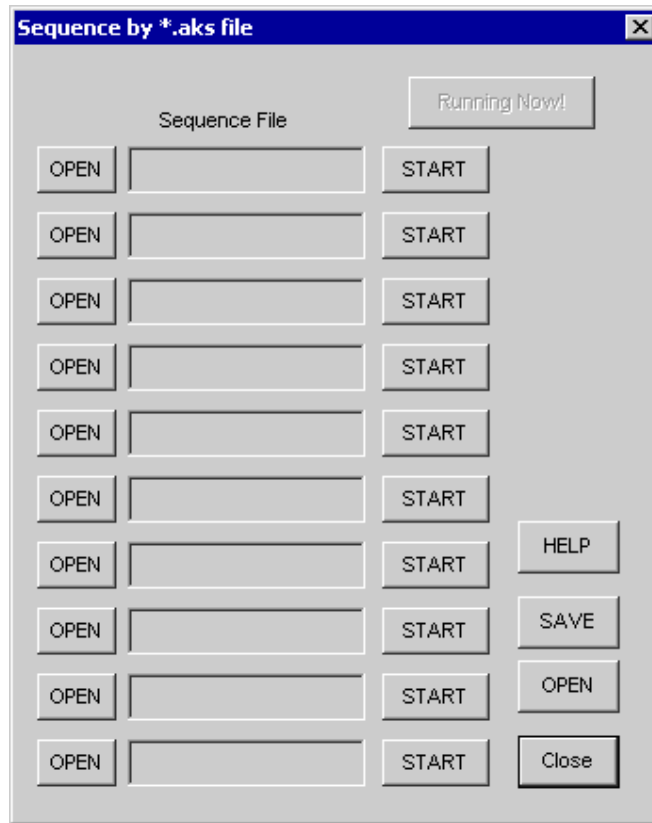

Figure 8. [F4] window

6-1. [OPEN] buttons on left side and [START] buttons

(1) Click [OPEN] button and select the sequence file (*.aks) saved by [Function3].

The sequence file name is displayed as shown in Figure 9. (In case that the selected sequence file name is "DAC_Stereo_ON.aks")

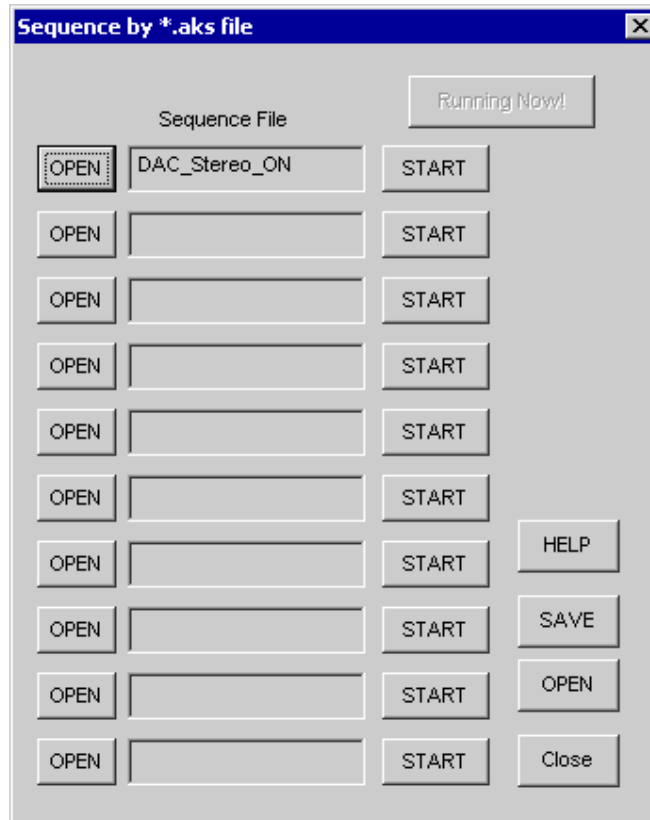

Figure 9. [F4] window(2)

(2) Click [START] button, then the sequence is executed.

6-2. [SAVE] and [OPEN] buttons on right side

[SAVE] : The name assign of sequence file displayed on [Function4] window can be saved to the file. The file name is "*.ak4".

[OPEN] : The name assign of sequence file (*.ak4) saved by [SAVE] is loaded.

6-3. Note

(1) This function doesn't support the pause function of sequence function.

(2) All files used by [SAVE] and [OPEN] function on right side need to be in the same folder.

(3) When the sequence is changed in [Function3], the sequence file (*.aks) should be loaded again in order to reflect the change.

7. [Function5 Dialog]

The register setting file(*.akr) saved by [SAVE] function on main window can be listed up to 10 files, assigned to buttons and then executed. When [F5] button is clicked, the window as shown in Figure 10 opens.

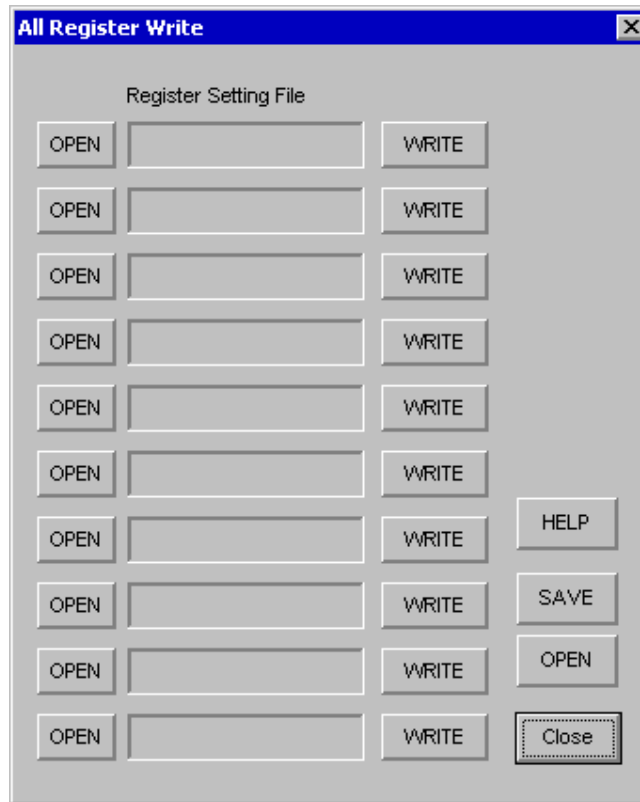

Figure 10. [F5] window

7-1. [OPEN] buttons on left side and [WRITE] button

- (1) Click [OPEN] button and select the register setting file (*.akr).

The register setting file name is displayed as shown in Figure 11. (In case that the selected file name is "DAC_Output.akr")

- (2) Click [WRITE] button, then the register setting is executed.

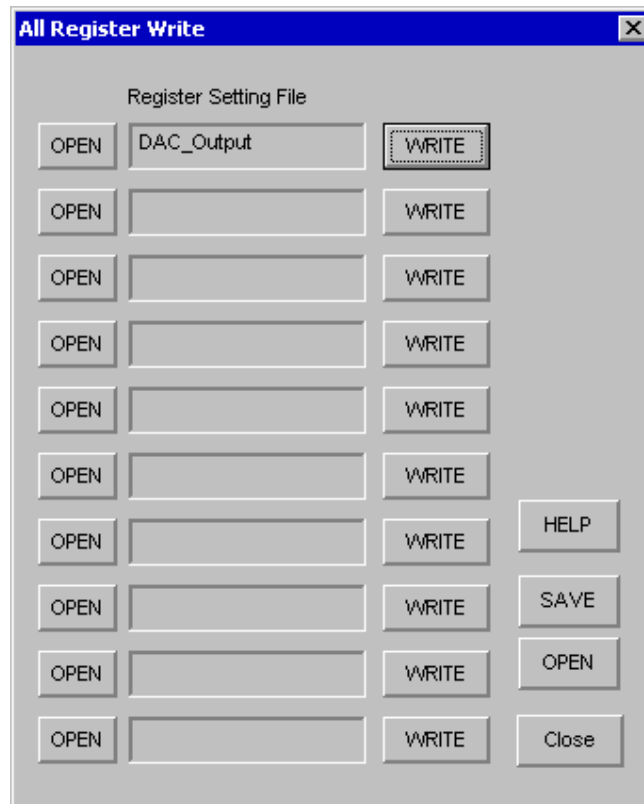

Figure 11. [F5] windows(2)

7-2. [SAVE] and [OPEN] buttons on right side

[SAVE] : The name assign of register setting file displayed on [Function5] window can be saved to the file. The file name is “*.ak5”.

[OPEN] : The name assign of register setting file(*.ak5) saved by [SAVE] is loaded.

7-3. Note

- (1) All files used by [SAVE] and [OPEN] function on right side need to be in the same folder.
- (2) When the register setting is changed by [SAVE] Button on the main window, the register setting file (*.akr) should be loaded again in order to reflect the change.

MEASUREMENT RESULTS

[Measurement condition]

- Measurement unit : Audio Precession System Two Cascade
- MCLK : 256fs
- BICK : 64fs
- fs : 44.1kHz, 96kHz
- Bit : 24bit
- Power Supply : AVDD = DVDD = HVDD = PVDD = TVDD = 3.3V
- Measurement Filter : 10Hz ~ 20kHz(fs= 44.1kHz), 10Hz ~ 40kHz(fs= 96kHz)
- Temperature : Room

fs= 44.1kHz

Parameter	Result (Lch / Rch)	Unit
Headphone-Amp: (DAC → HPL/HPR pins), RL=16Ω		
THD+N (-4dBFS Output)	-61.7 / -61.4	dB
D-Range (-60dB Output, A-weighted)	94.9 / 94.4	dB
S/N (A-weighted)	94.6 / 94.5	dB

Parameter	Result (Lch / Rch)	Unit
Line Output: (DAC → LOUT/ROUT pins)		
THD+N (0dBFS Output)	-89.5 / -89.1	dB
D-Range (-60dB Output, A-weighted)	99.7 / 99.8	dB
S/N (A-weighted)	99.7 / 99.8	dB

Parameter	Result (Lch / Rch)	Unit
Aux Output: (DAC → LAUX/RAUX pins)		
THD+N (0dBFS Output)	-88.0 / -87.2	dB
D-Range (-60dB Output, A-weighted)	95.1 / 94.8	dB
S/N (A-weighted)	95.1 / 94.8	dB

fs= 96kHz

Parameter	Result (Lch / Rch)	Unit	
Headphone-Amp: (DAC → HPL/HPR pins), RL=16Ω			
THD+N (-4dBFS Output)	-61.7 / -61.3	dB	
D-Range	(-60dB Output, A-weighted)	94.6 / 95.0	dB
	(-60dB Output)	90.1 / 90.5	dB
S/N	(A-weighted)	94.7 / 95.1	dB
		90.1 / 90.5	dB

Parameter	Result (Lch / Rch)	Unit	
Line Output: (DAC → LOUT/ROUT pins)			
THD+N (0dBFS Output)	-88.4 / -88.2	dB	
D-Range	(-60dB Output, A-weighted)	99.4 / 99.3	dB
	(-60dB Output)	94.9 / 94.9	dB
S/N	(A-weighted)	99.5 / 99.6	dB
		95.1 / 95.1	dB

Parameter	Result (Lch / Rch)	Unit	
Aux Output: (DAC → LAUX/RAUX pins)			
THD+N (0dBFS Output)	-87.0 / -86.4	dB	
D-Range	(-60dB Output, A-weighted)	95.1 / 94.8	dB
	(-60dB Output)	90.3 / 90.4	dB
S/N	(A-weighted)	95.1 / 94.9	dB
		90.3 / 90.5	dB

[fs=44.1kHz]
[Plot of Headphone Amp]

Figure 12. THD+N vs. Input Level

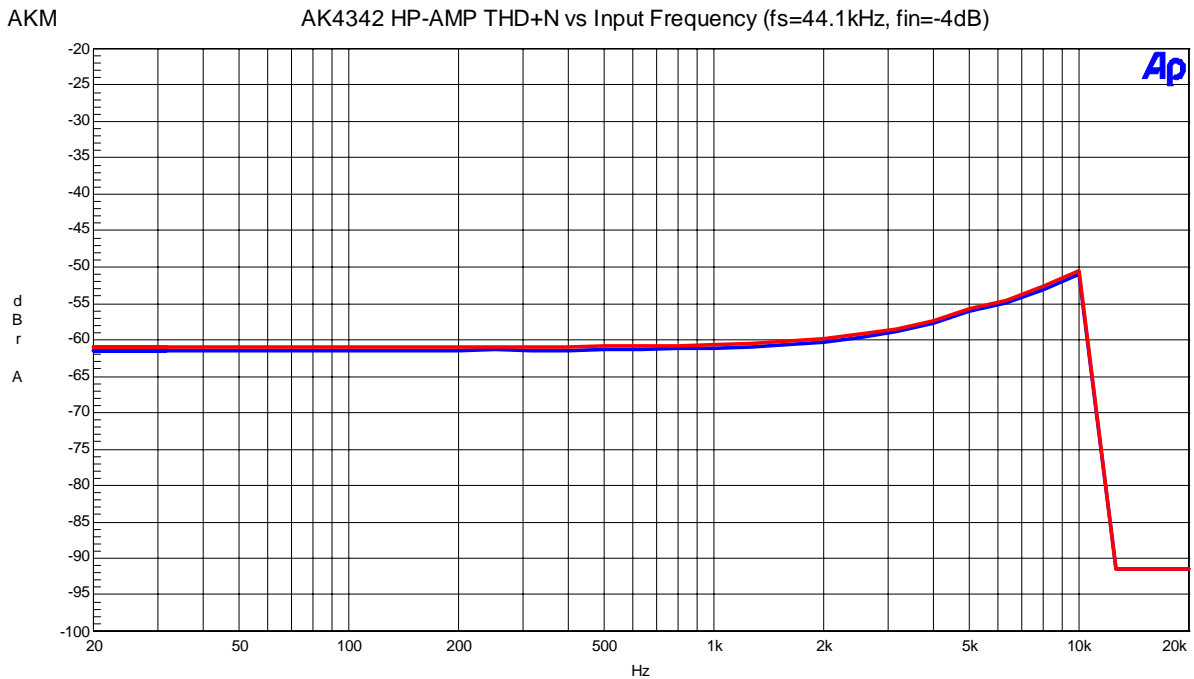
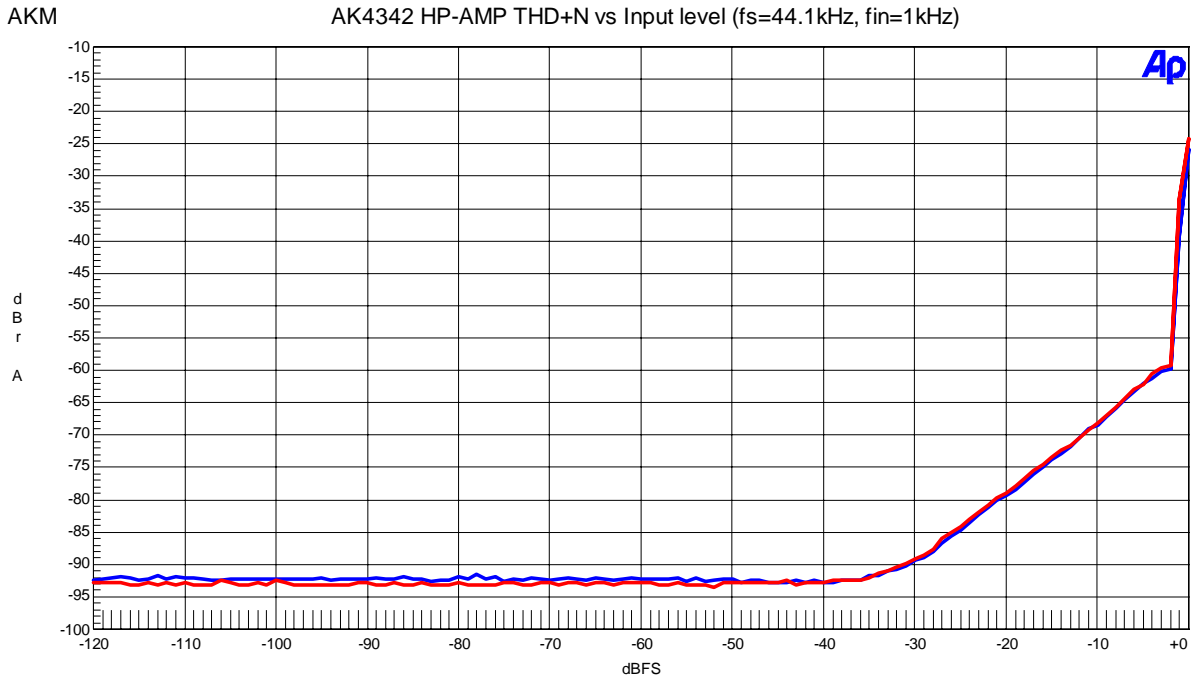

Figure 13. THD+N vs. Input Frequency

AK4342 HP-AMP Linearity (fs=44.1kHz, fin=1kHz)

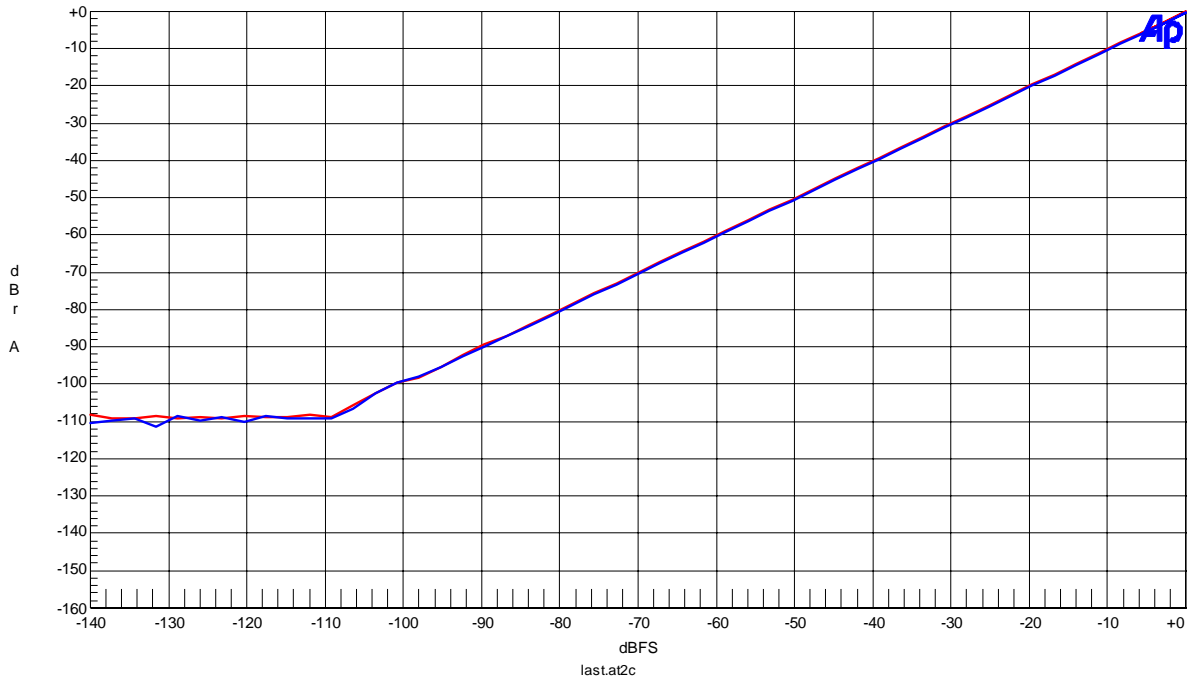

Figure 14. Linearity

AK4342 HP-AMP Frequency Response (fs=44.1kHz, fin=0dBFS)

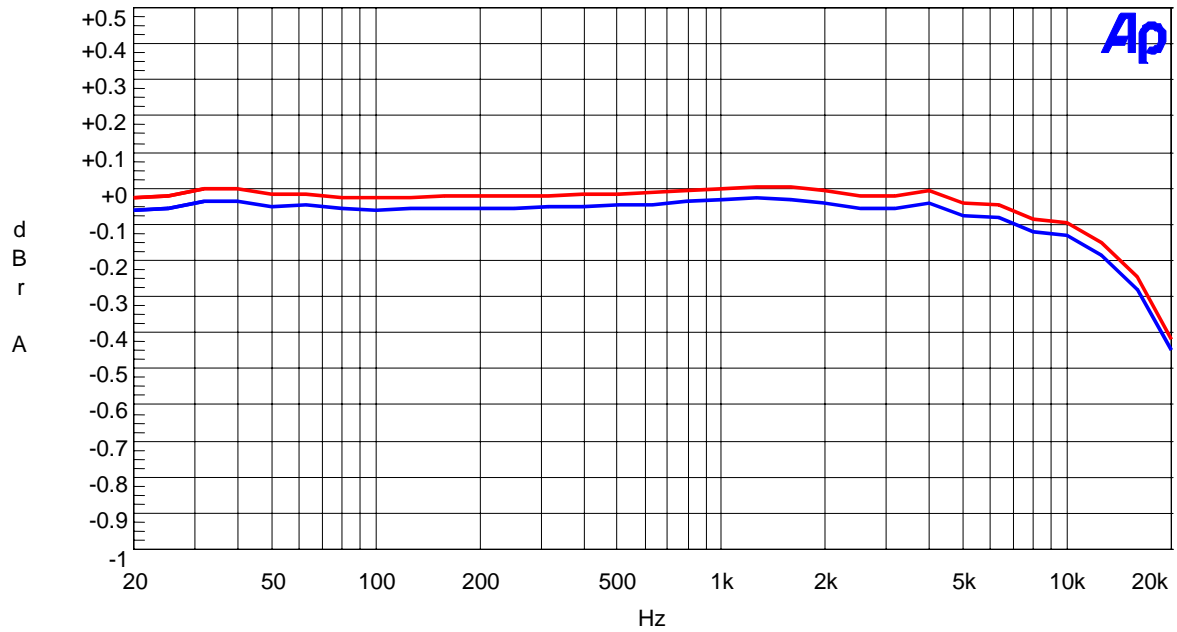

Figure 15. Frequency Response

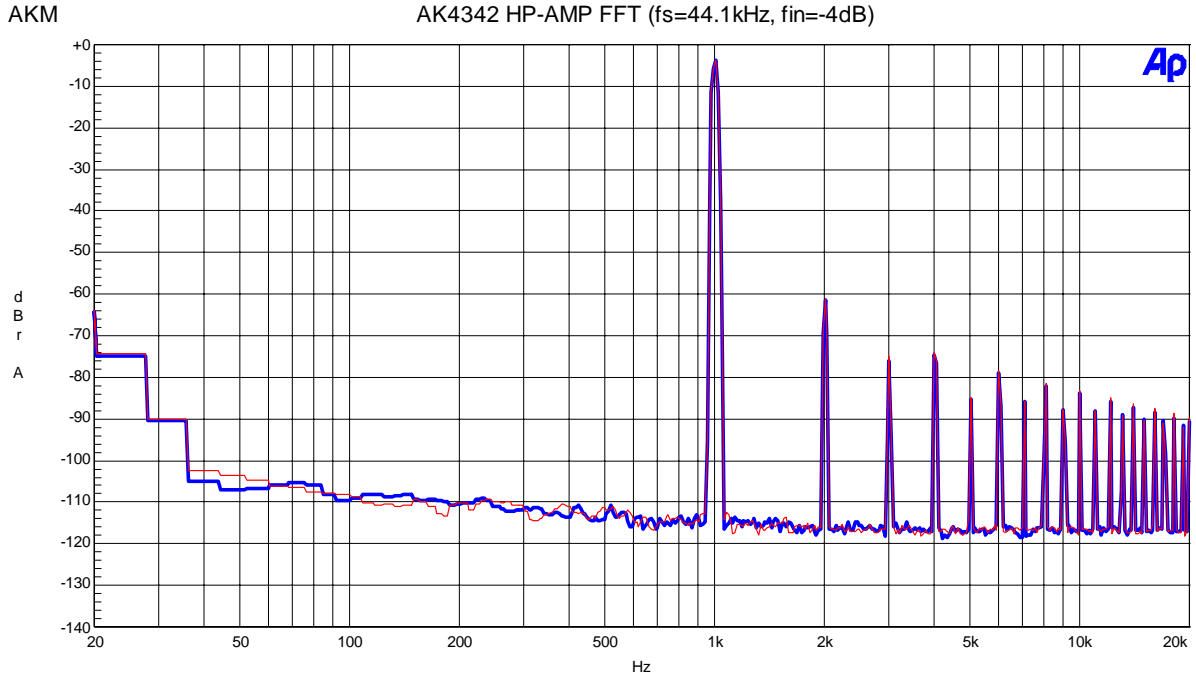

Figure 16. FFT Plot (1kHz, -4dB)

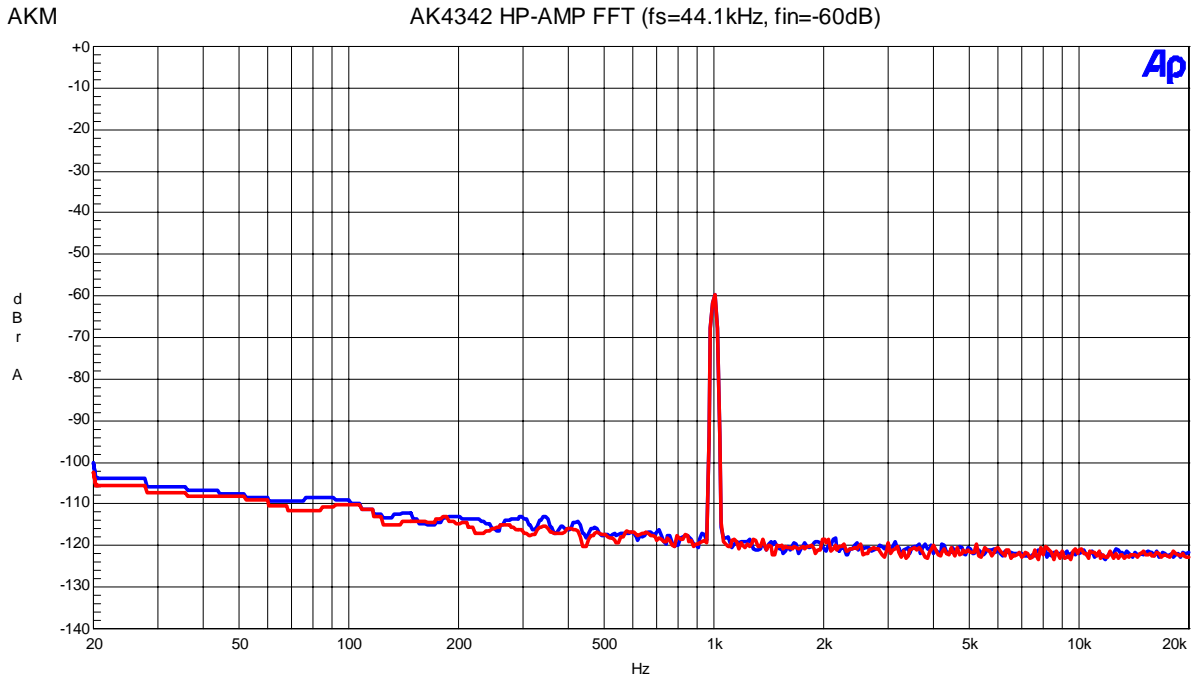

Figure 17. FFT Plot (1kHz, -60dB)

AK4342 HP-AMP FFT (Noise Floor)

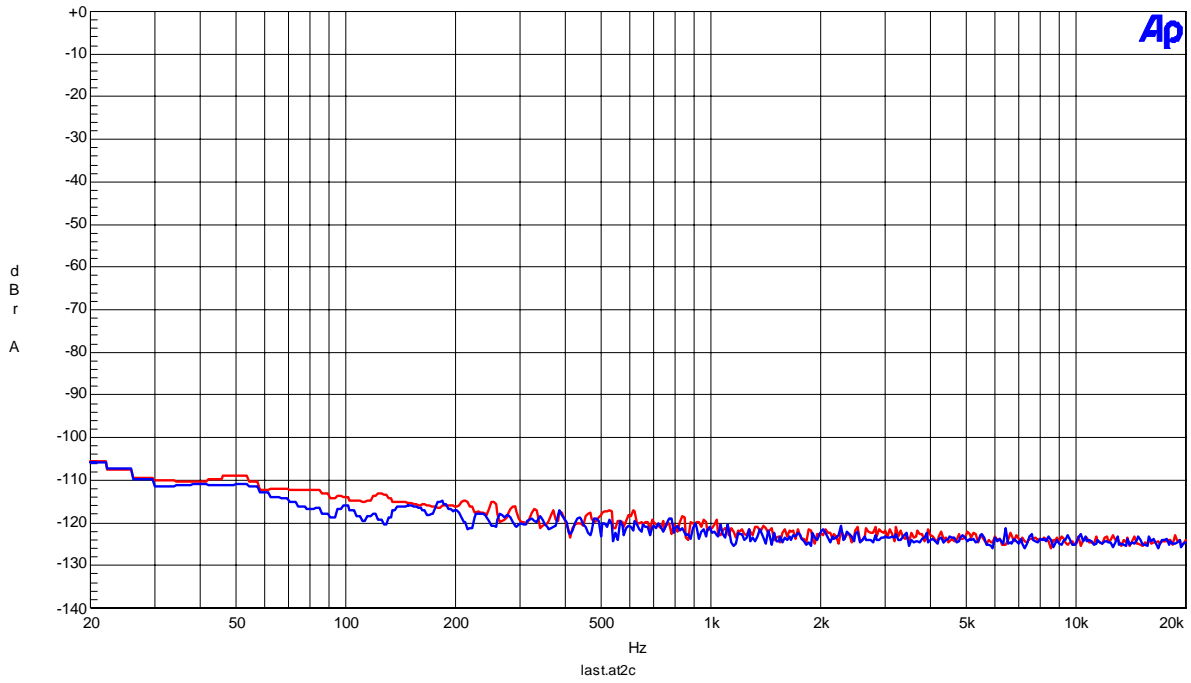

Figure 18. FFT Plot (Noise Floor)

AK4342 HP-AMP FFT (Out-band Noise)

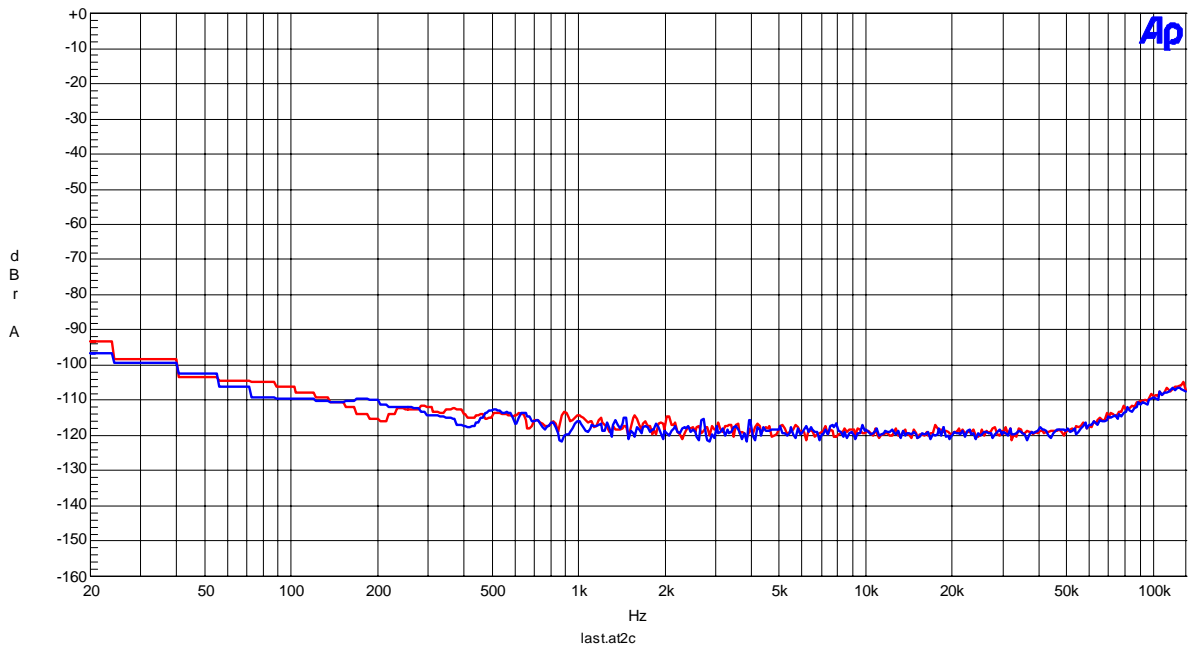

Figure 19. Out-of-band Noise

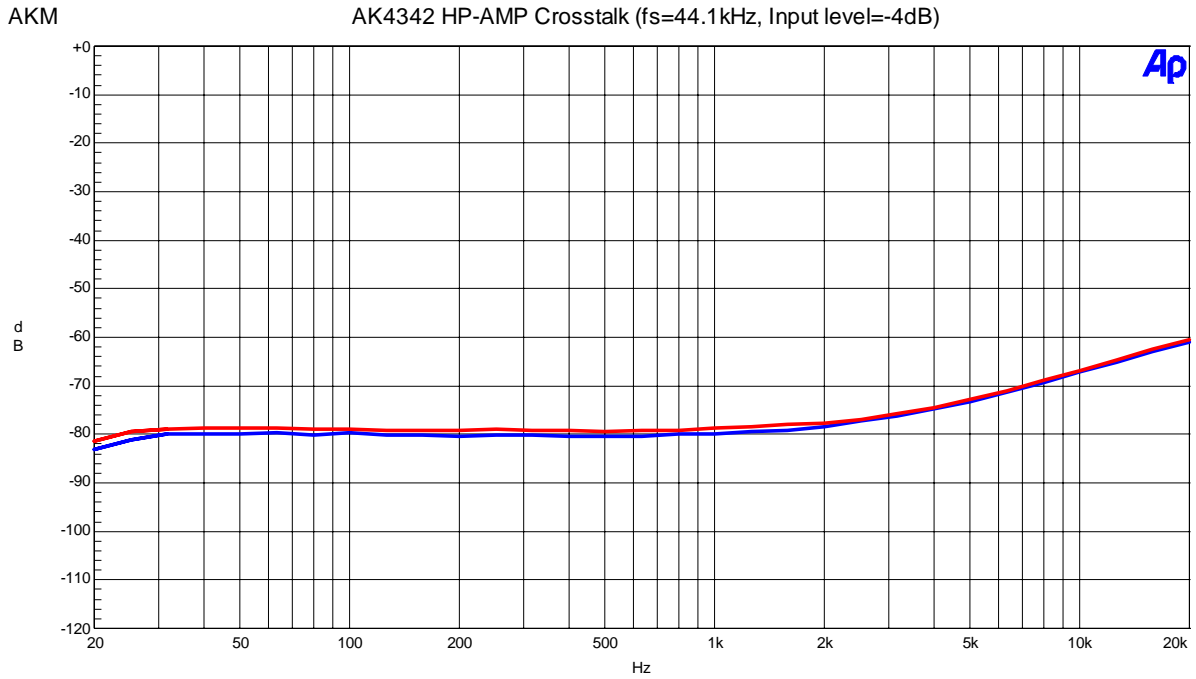

Figure 20.Crosstalk

[Plot of Lineout]

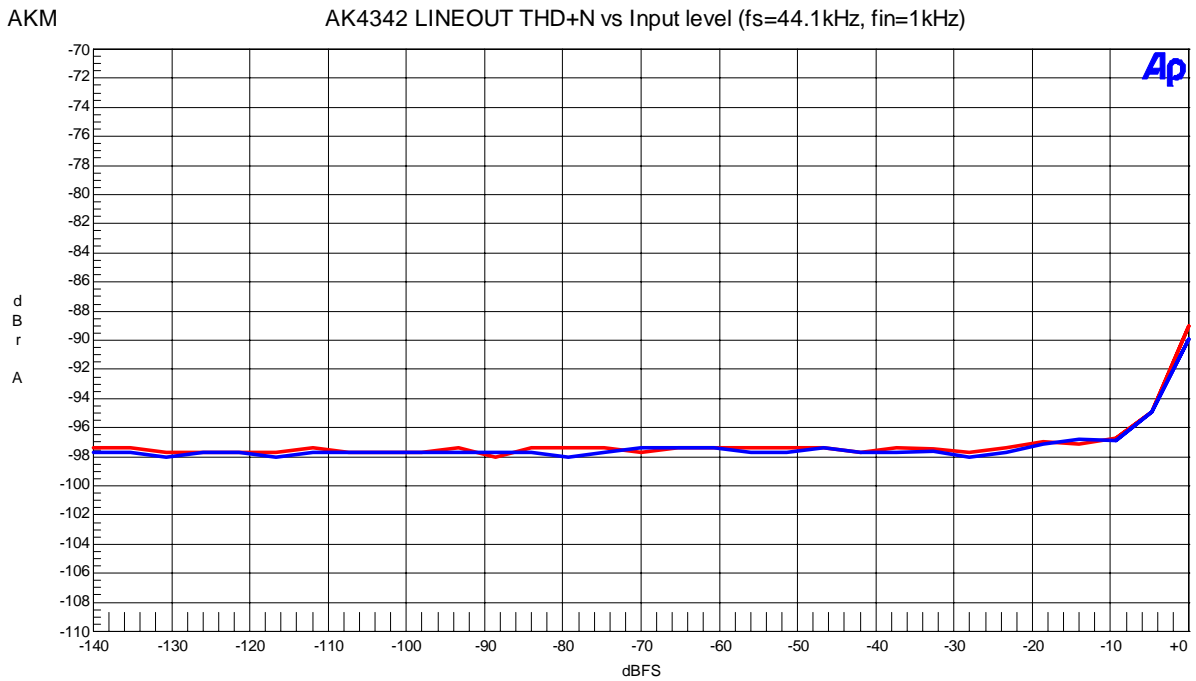

Figure 21. THD+N vs. Input level

AKM

AK4342 LINEOUT THD+N vs Input Frequency (fs=44.1kHz, Input level=0dB)

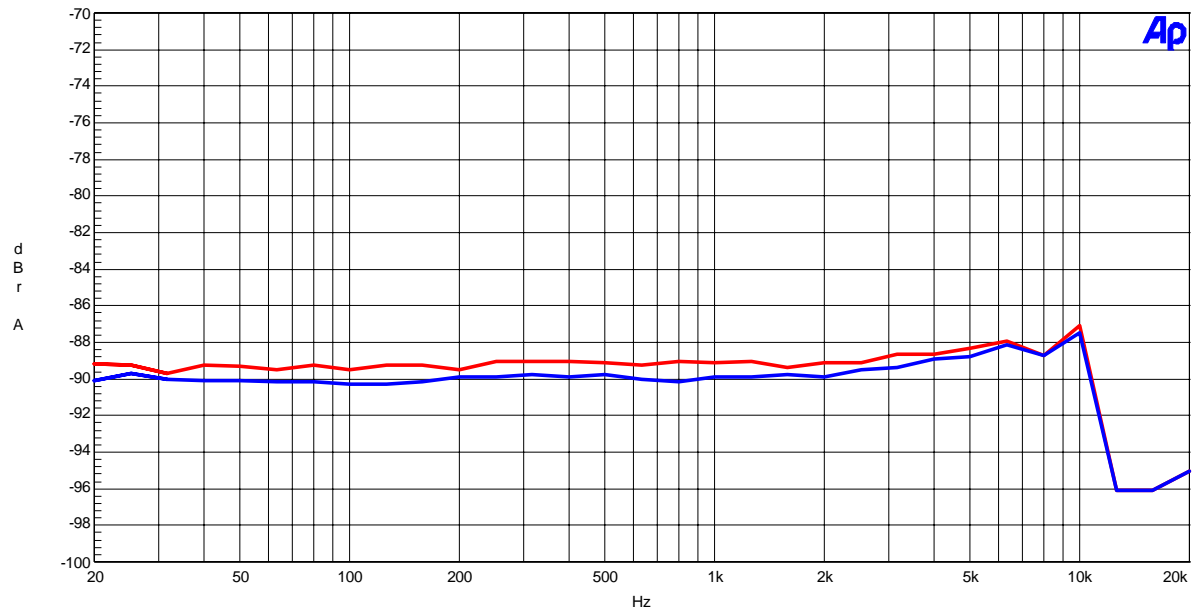

Figure 22. THD+N vs. Input Frequency

AK4342 LINEOUT Linearity (fs=44.1kHz, fin=1kHz)

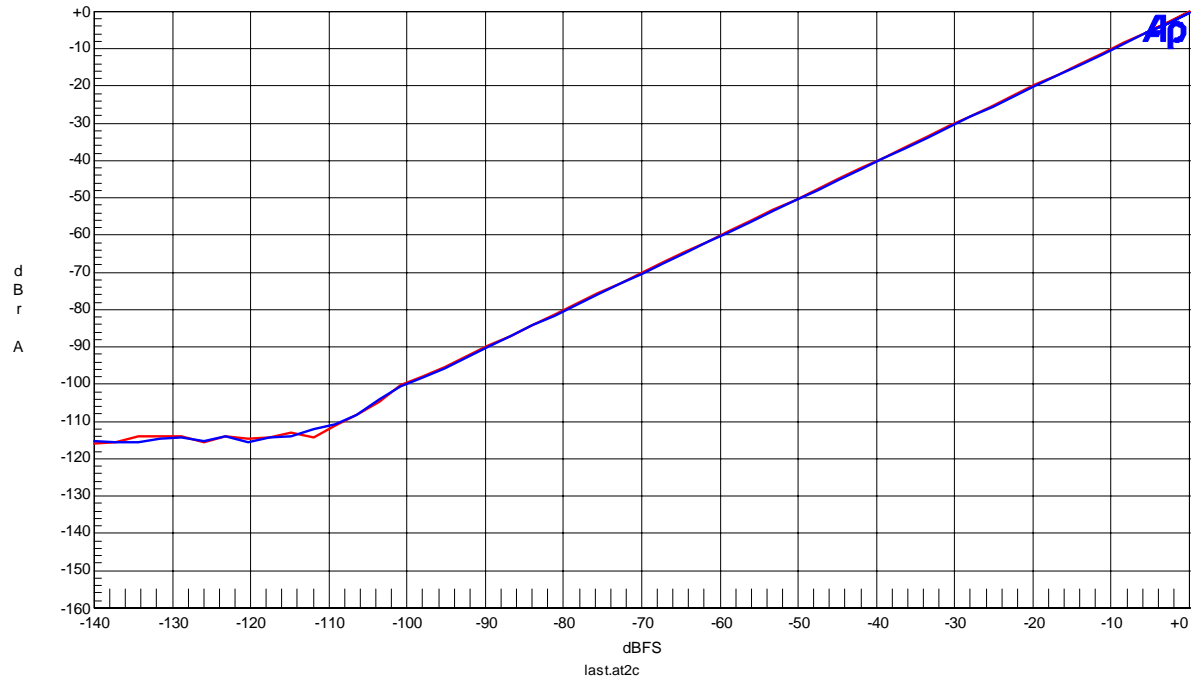

Figure 23. Linearity

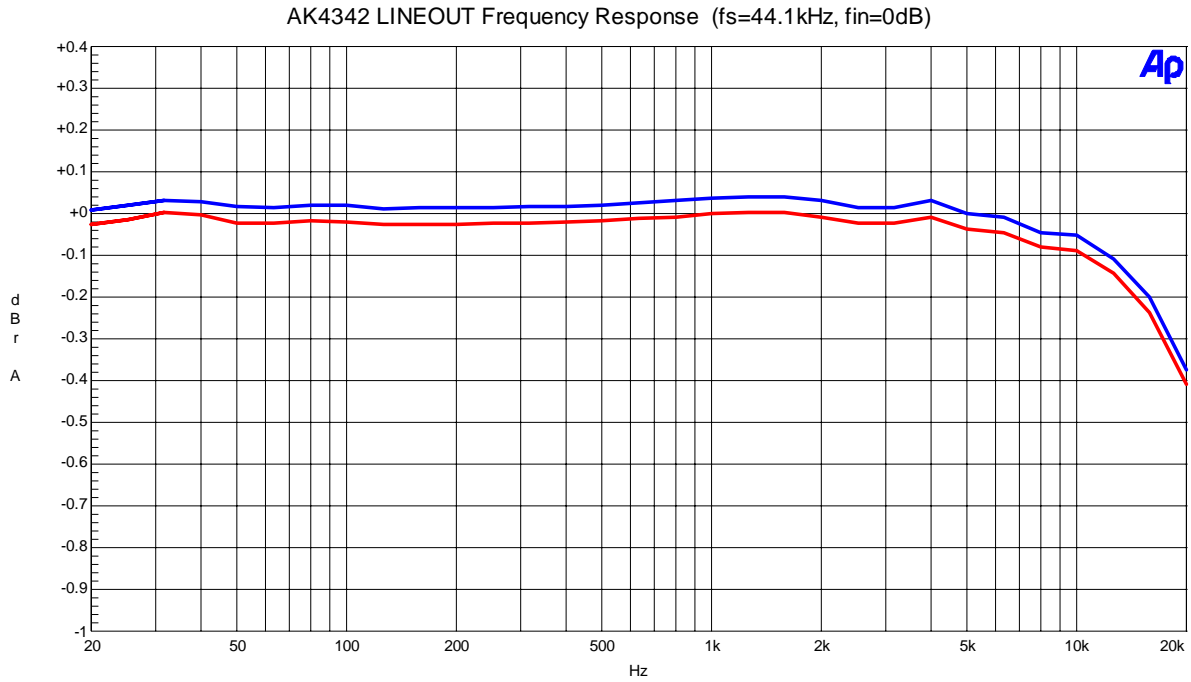

Figure 24. Frequency Response

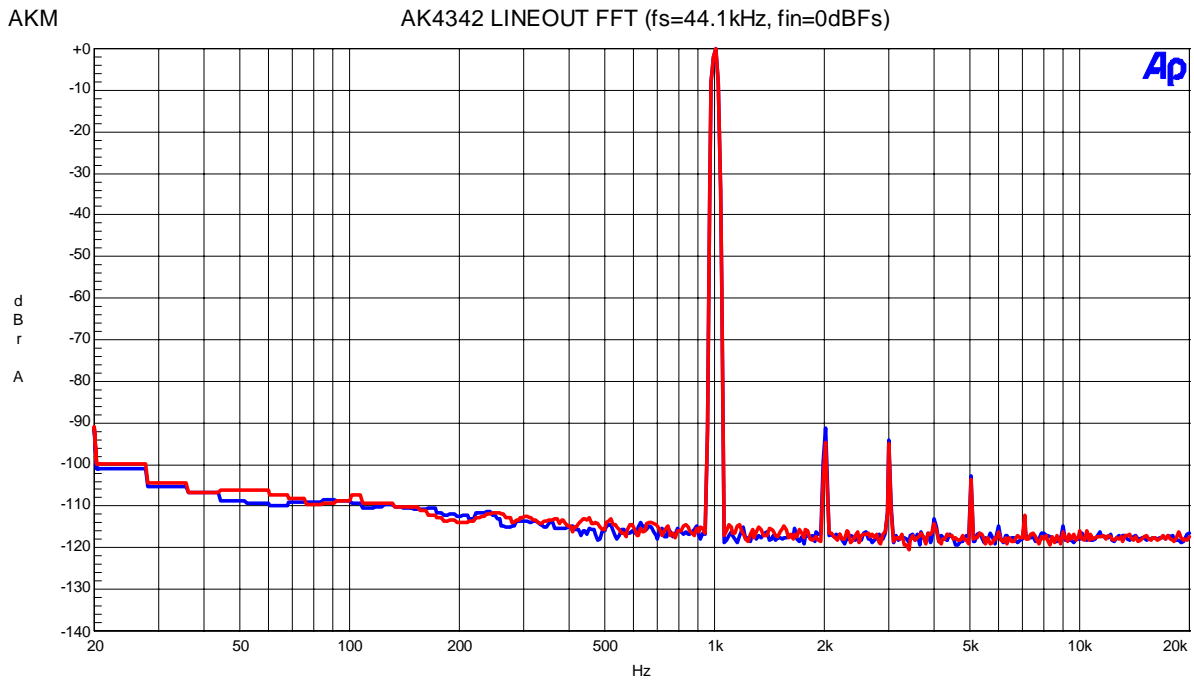

Figure 25. FFT Plot (1kHz, 0dBFs)

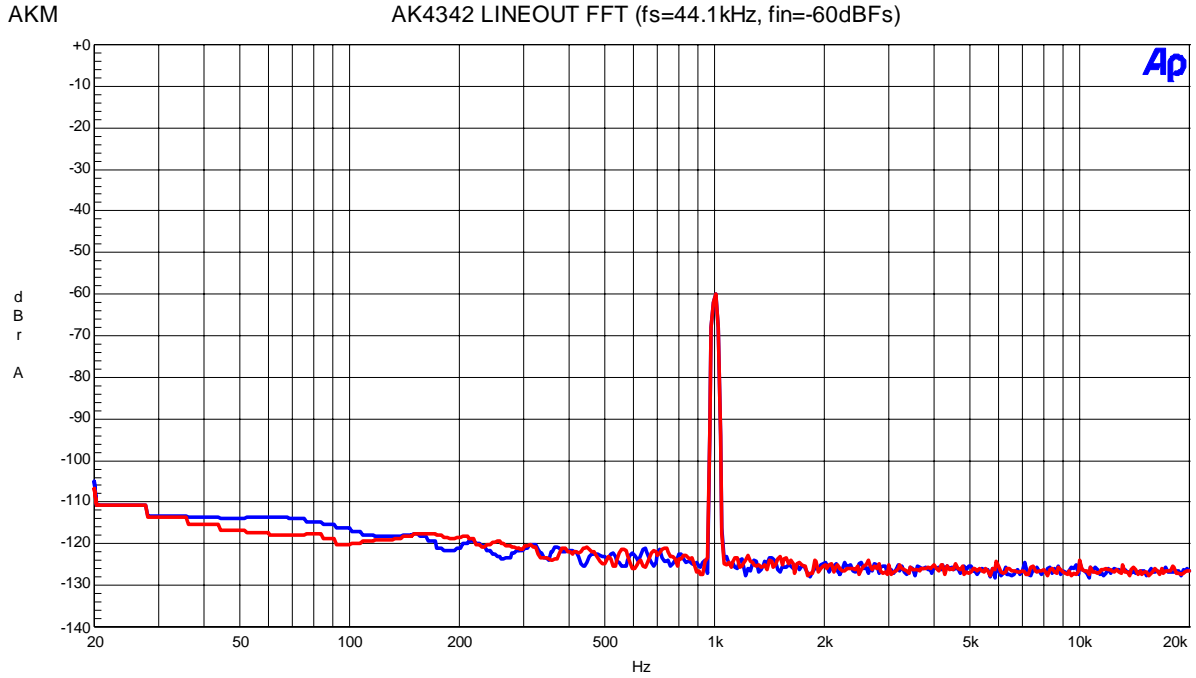

Figure 26. FFT Plot (1kHz, -60dBfs)

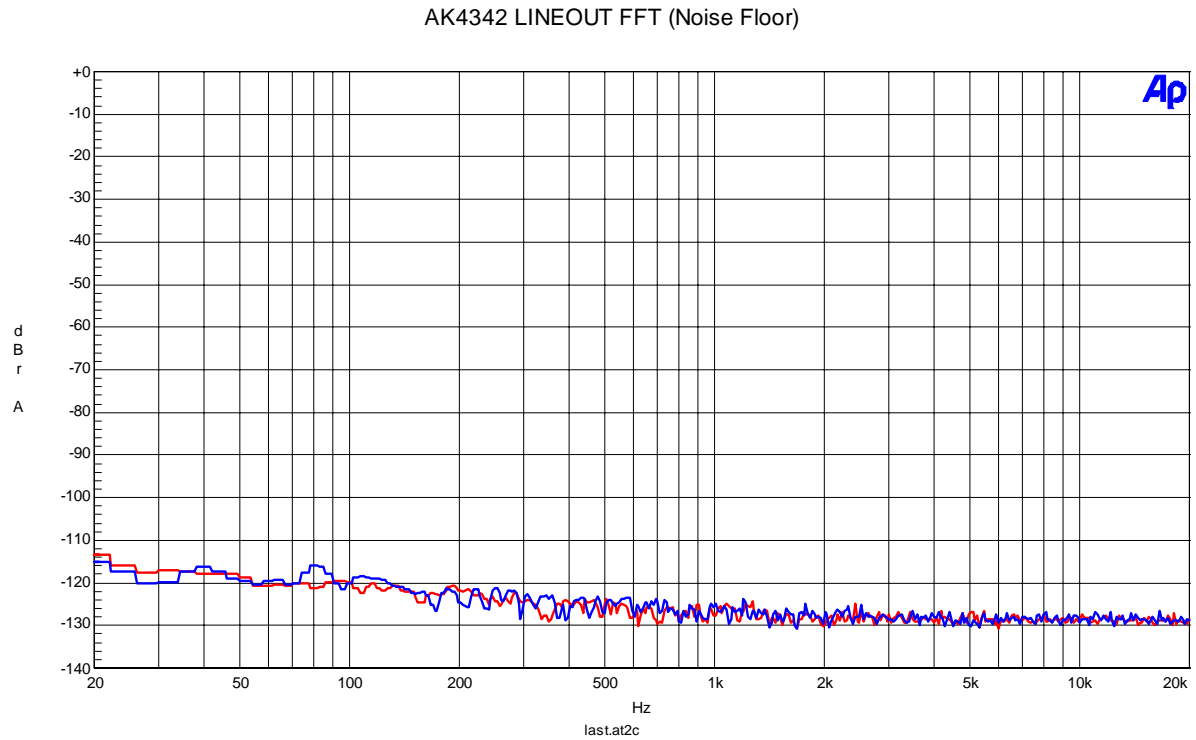

Figure 27. FFT Plot (Noise Floor)

AK4342 LINEOUT FFT (Out-band Noise)

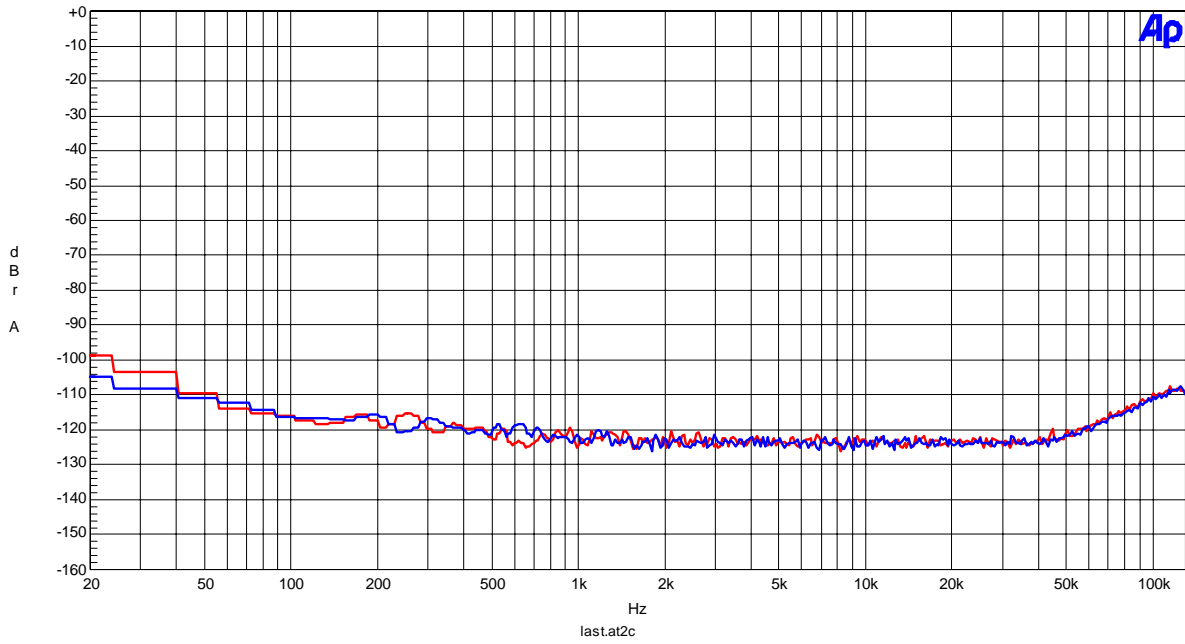

Figure 28. Out-of-band Noise

AKM

AK4342 LINEOUT Crosstalk (fs=44.1kHz, fin=0dB)

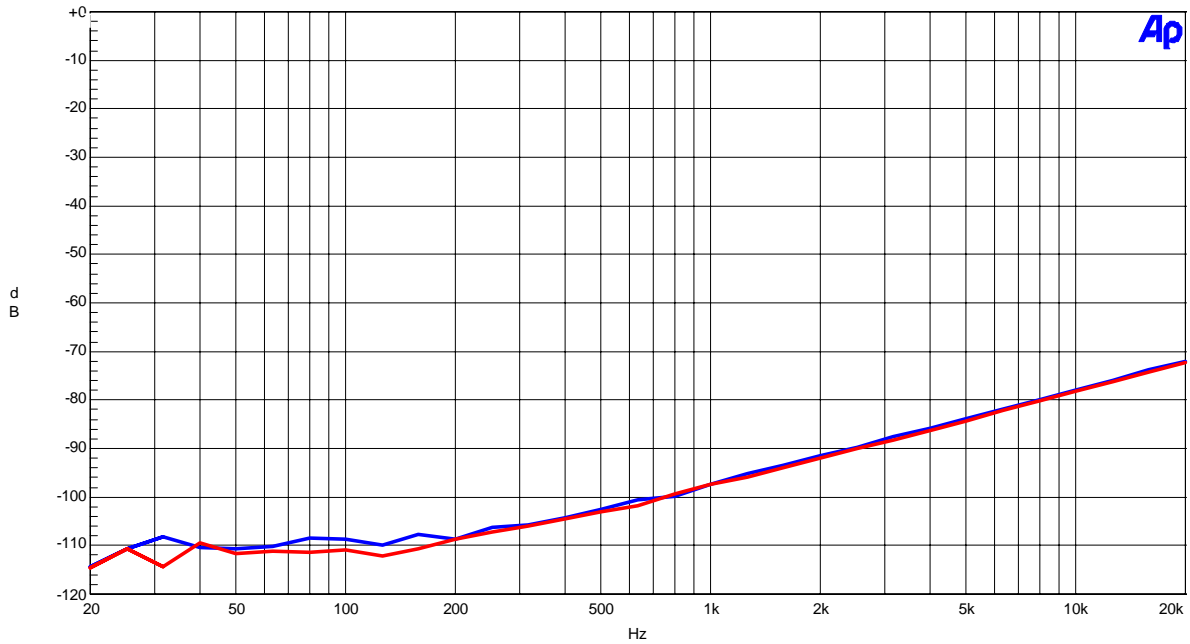

Figure 29. Crosstalk

[Plot of AUX]

AK4342 AUX THD+N vs. Input Level (fs=44.1kHz, fin=1kHz)

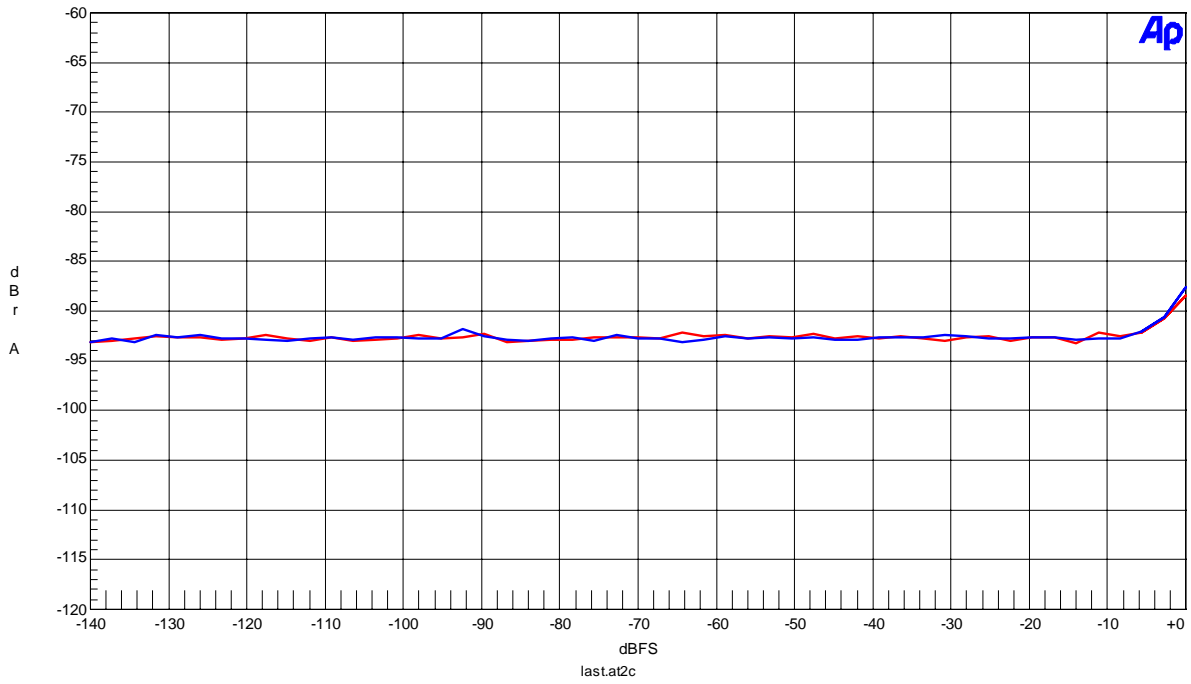

Figure 30. THD+N vs. Input Level

AK4342 AUX THD+N vs. Input Frequency (fs=44.1kHz, fin=0dBFS)

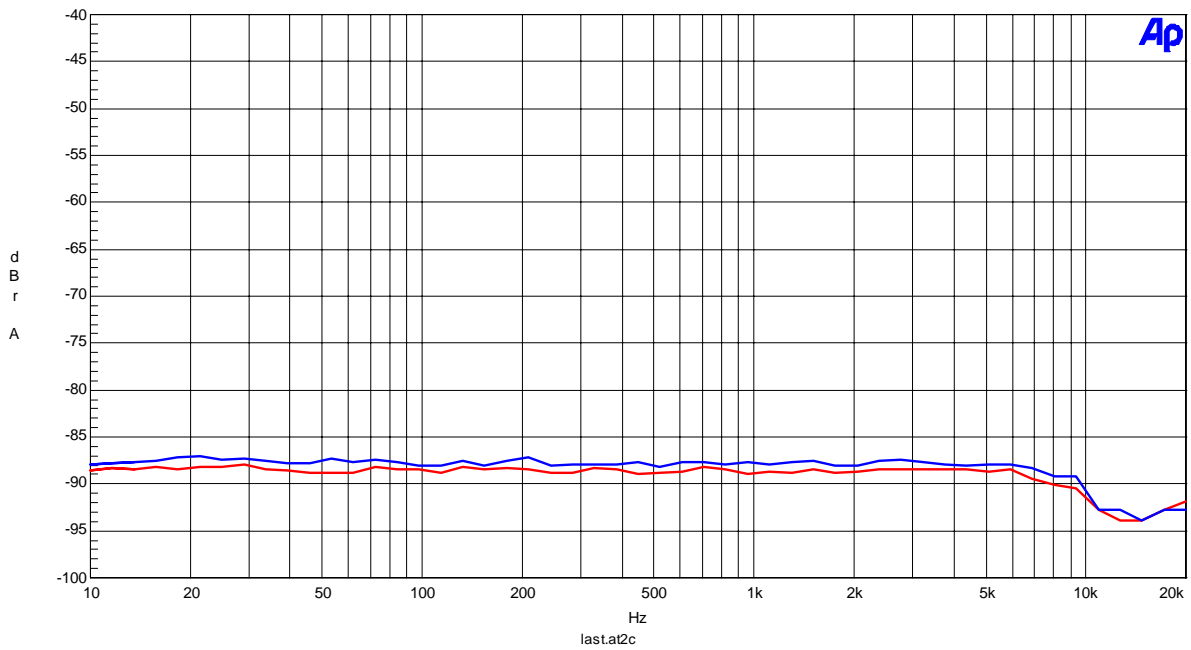

Figure 31. THD+N vs. Input Frequency

AK4342 AUX Linearity (fs=44.1kHz, fin=1kHz)

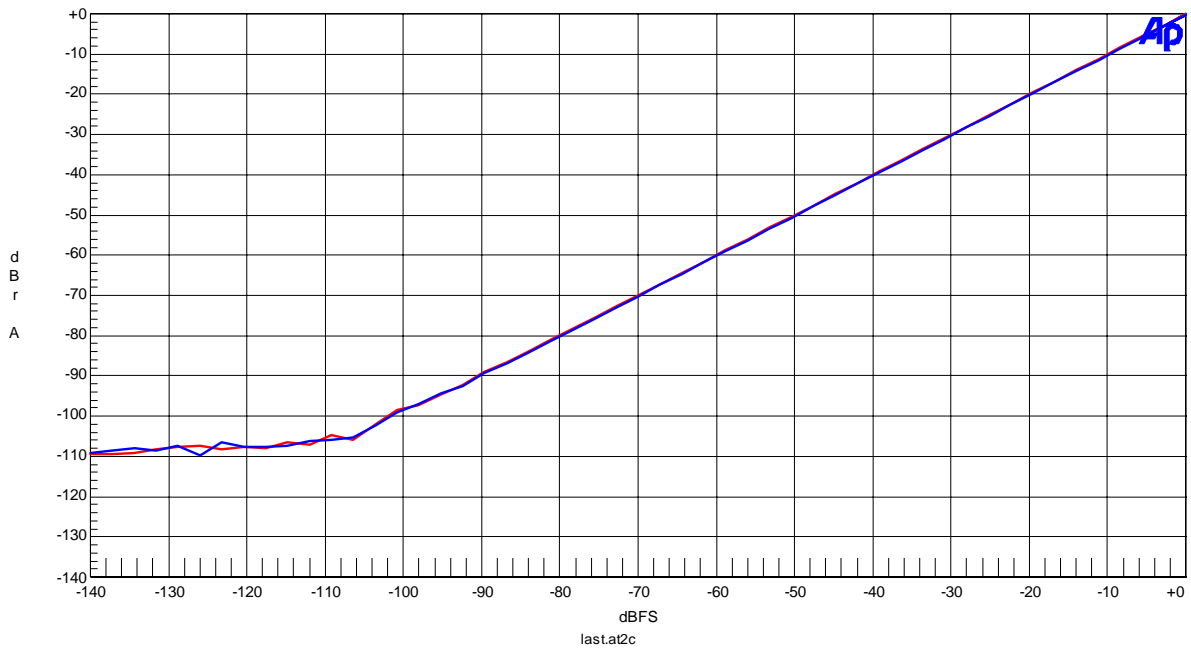

Figure 32. Linearity

AK4342 AUX Frequency Response (fs=44.1kHz, fin=0dB)

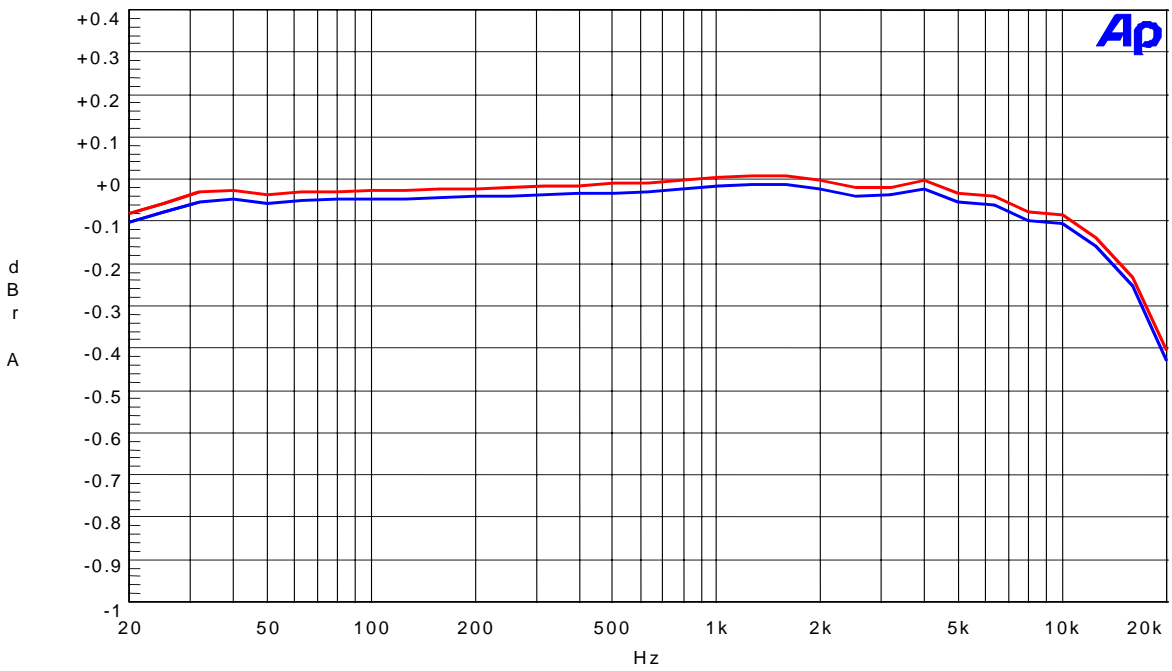

Figure 33. Frequency Response

AK4342 AUX FFT (fs=44.1kHz, fin=0dBfs)

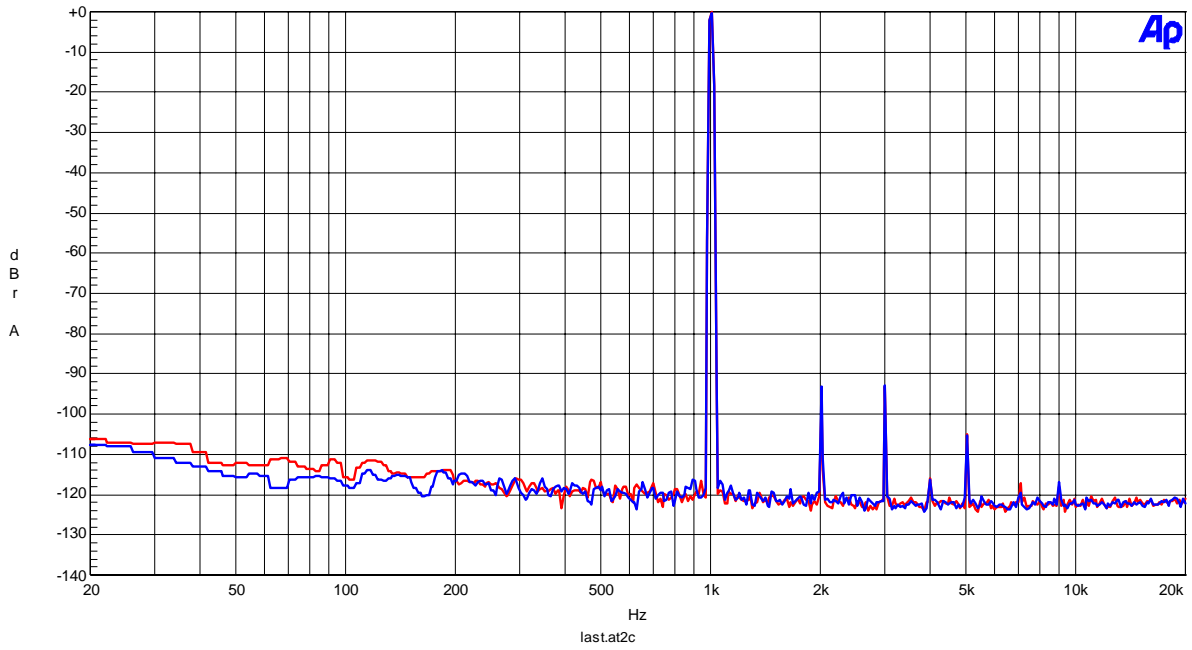

Figure 34. FFT Plot (1kHz, 0dB)

AK4342 AUX FFT (fs=44.1kHz, fin=-60dBfs)

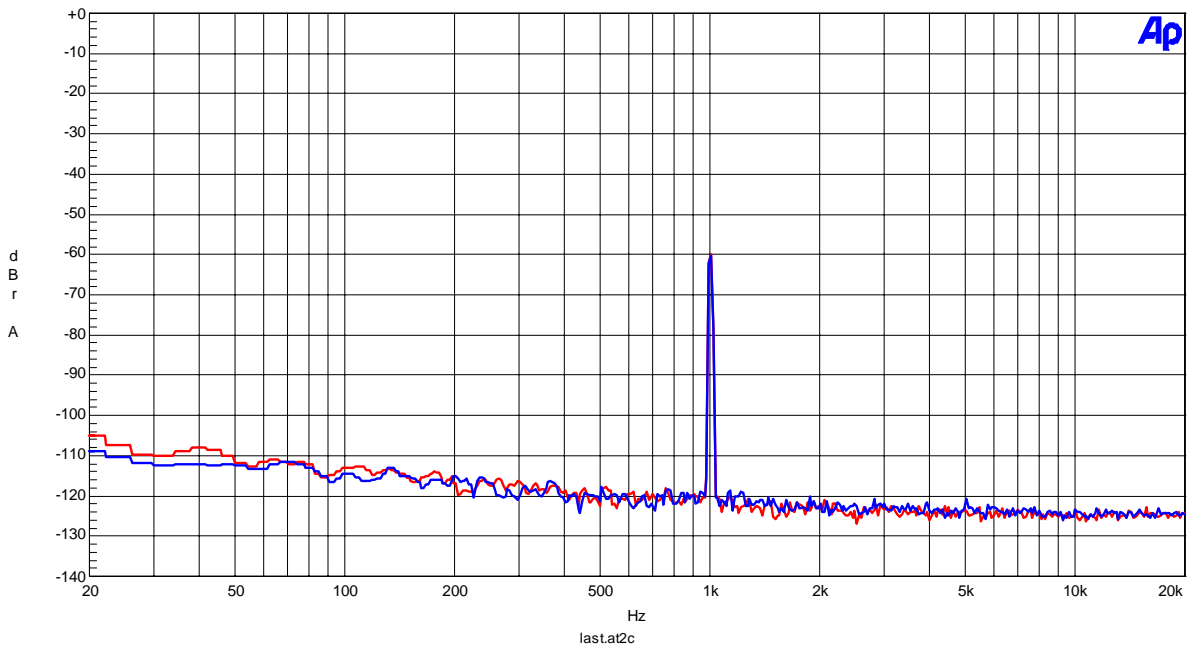

Figure 35. FFT Plot (1kHz, -60dB)

AK4342 AUX FFT (Noise Floor)

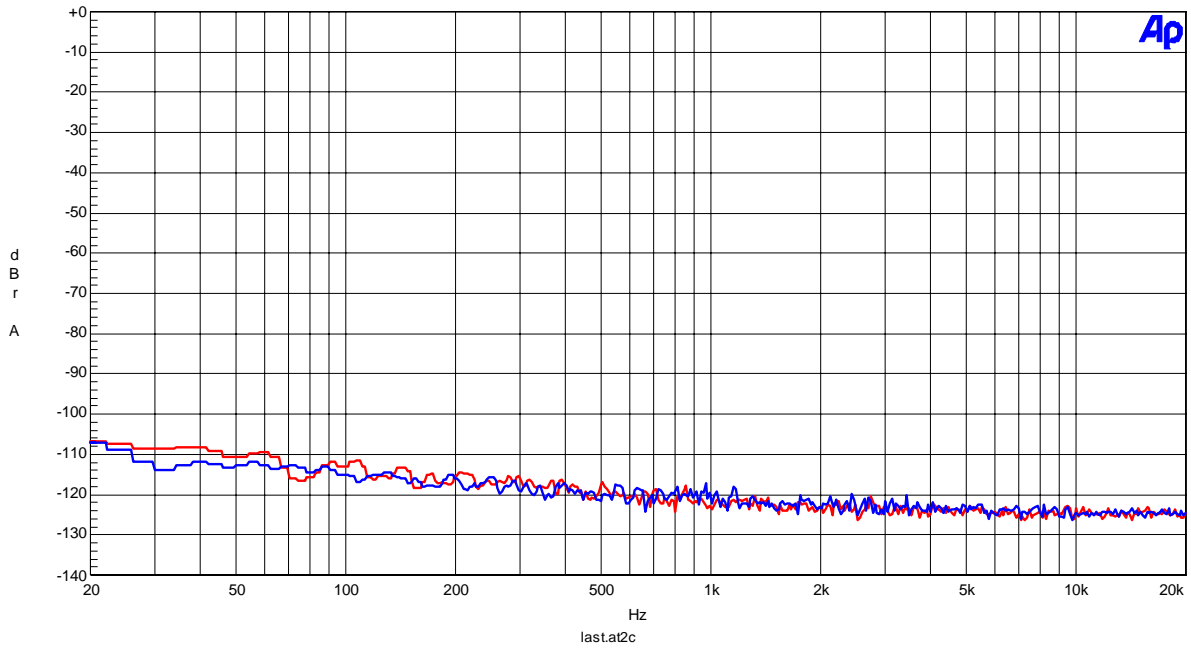

Figure 36. FFT Plot (Noise Floor)

AK4342 AUX FFT (Out-band Noise)

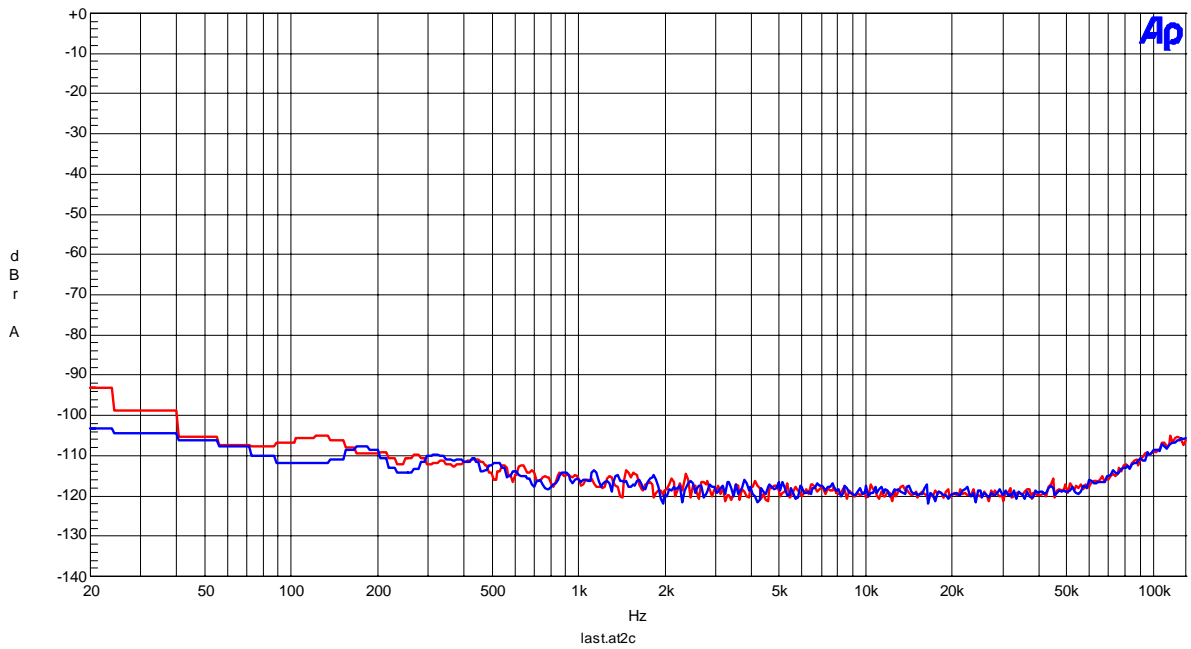

Figure 37. Out-of-band Noise

AK4342 AUX Crosstalk (fs=44.1kHz, fin=0dB)

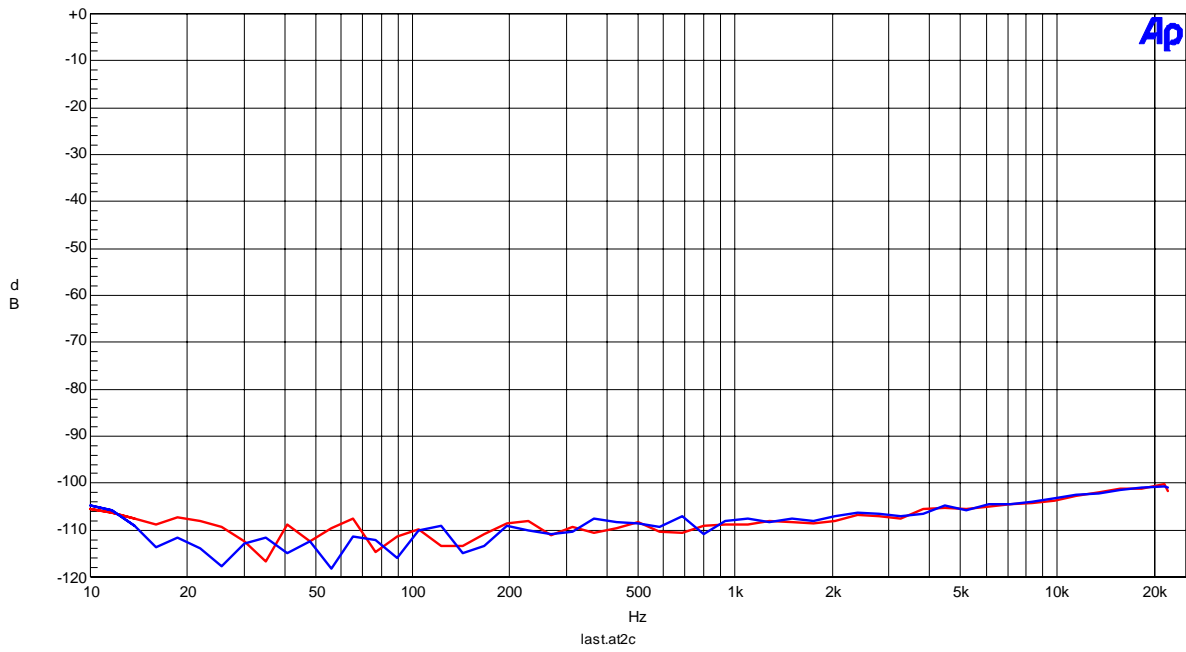

Figure 38. Crosstalk

[fs=96kHz]
[Plot of Headphone Amp]

AKM AK4342 HP-AMP THD+N vs Input level (fs=96kHz, fin=1kHz)

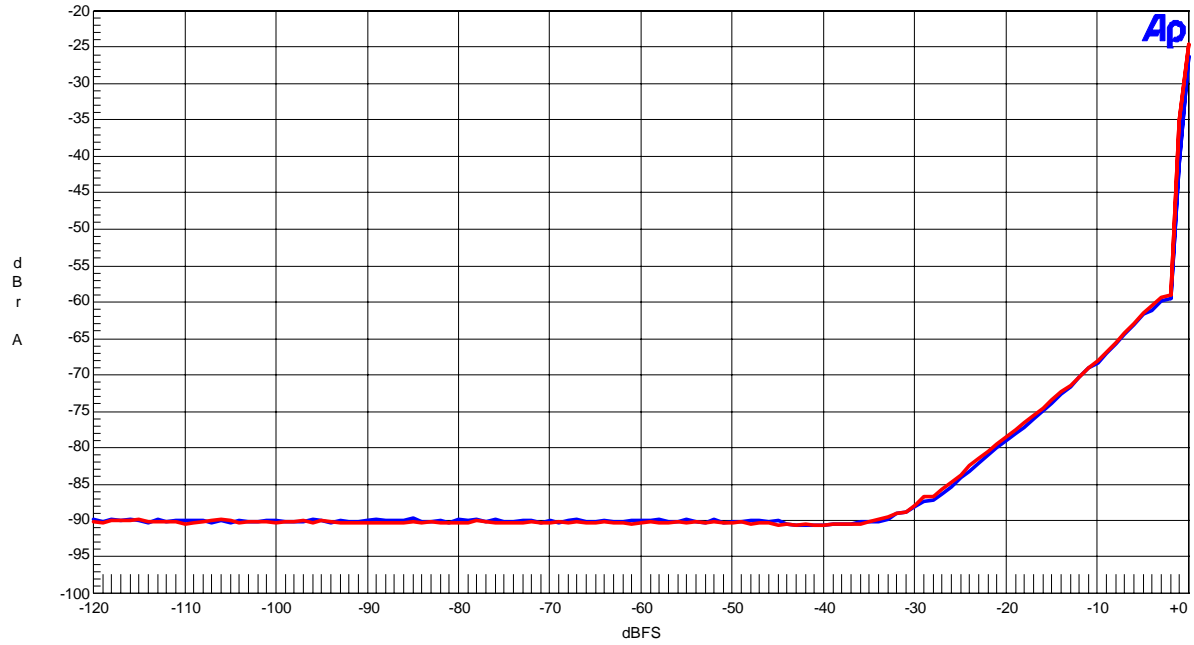

Figure 39. THD+N vs. Input Level

AKM AK4342 HP-AMP THD+N vs Input Frequency (fs=96kHz, fin=-4dB)

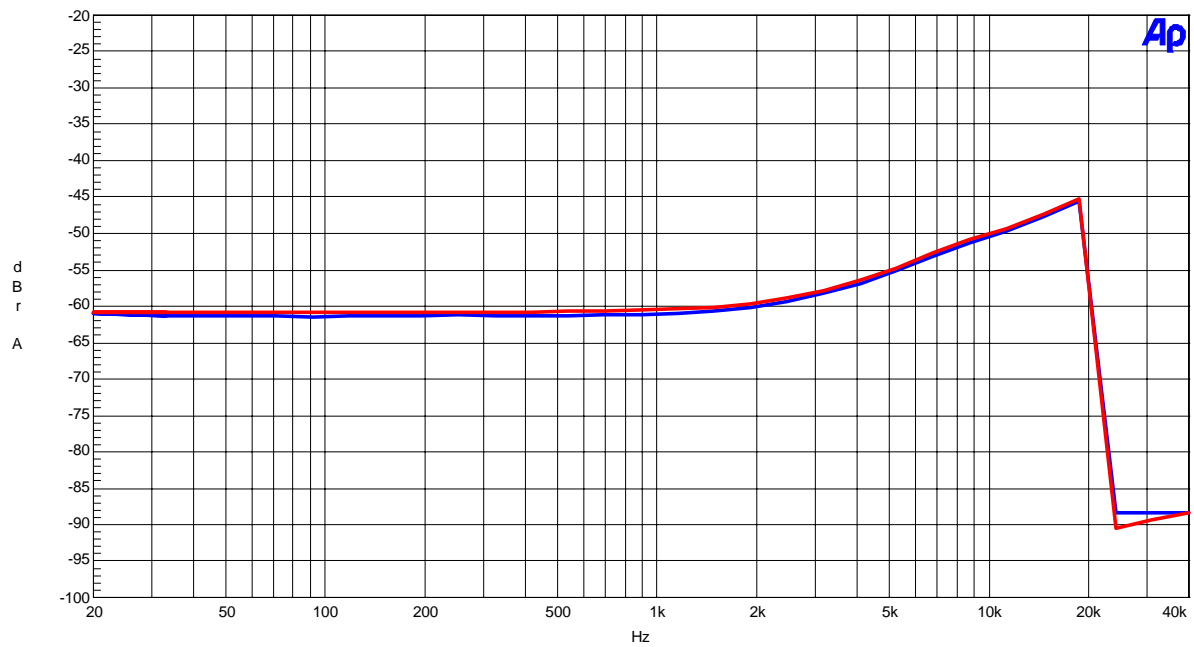

Figure 40. THD+N vs. Input Frequency

AK4342 HP-AMP Linearity (fs=96kHz, fin=1kHz)

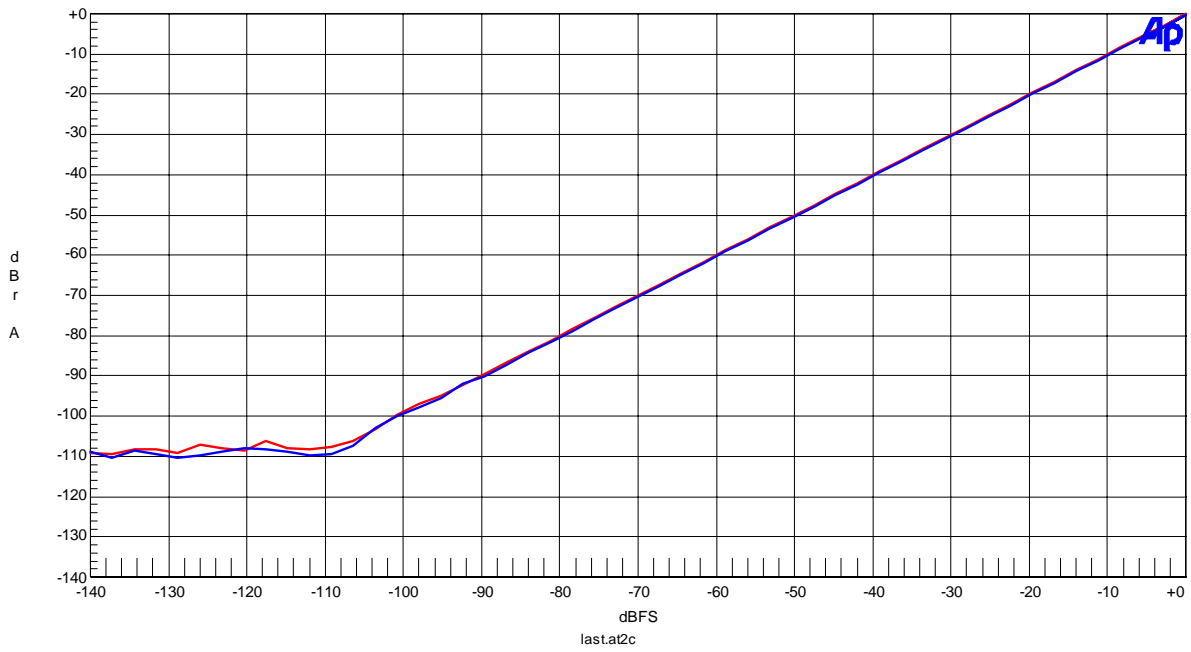

Figure 41. Linearity

AK4342 HP-AMP Frequency Response (fs=96kHz, fin=0dBFS)

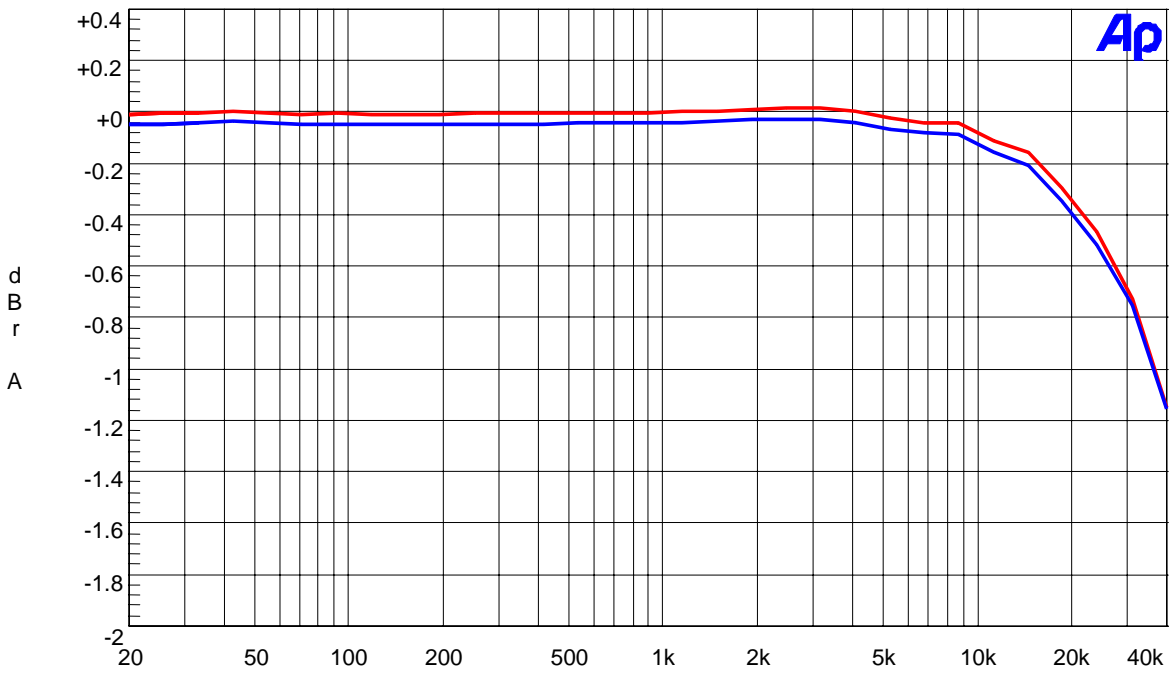

Figure 42. Frequency Response

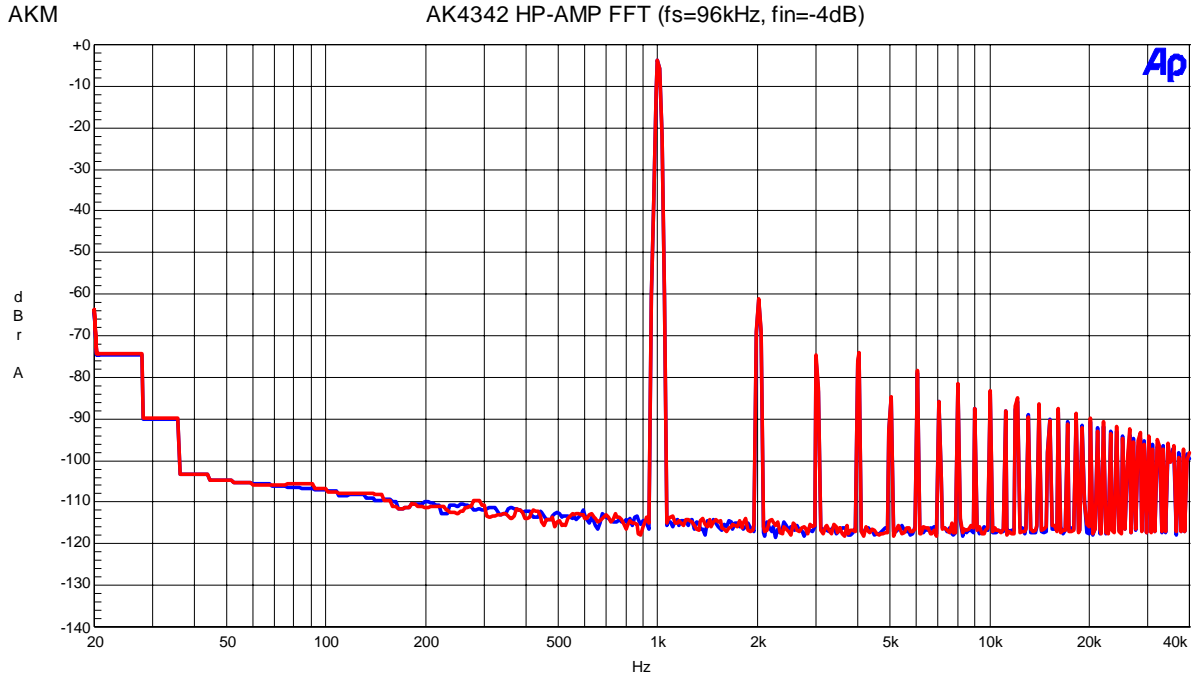

Figure 43. FFT Plot (1kHz,-4dB)

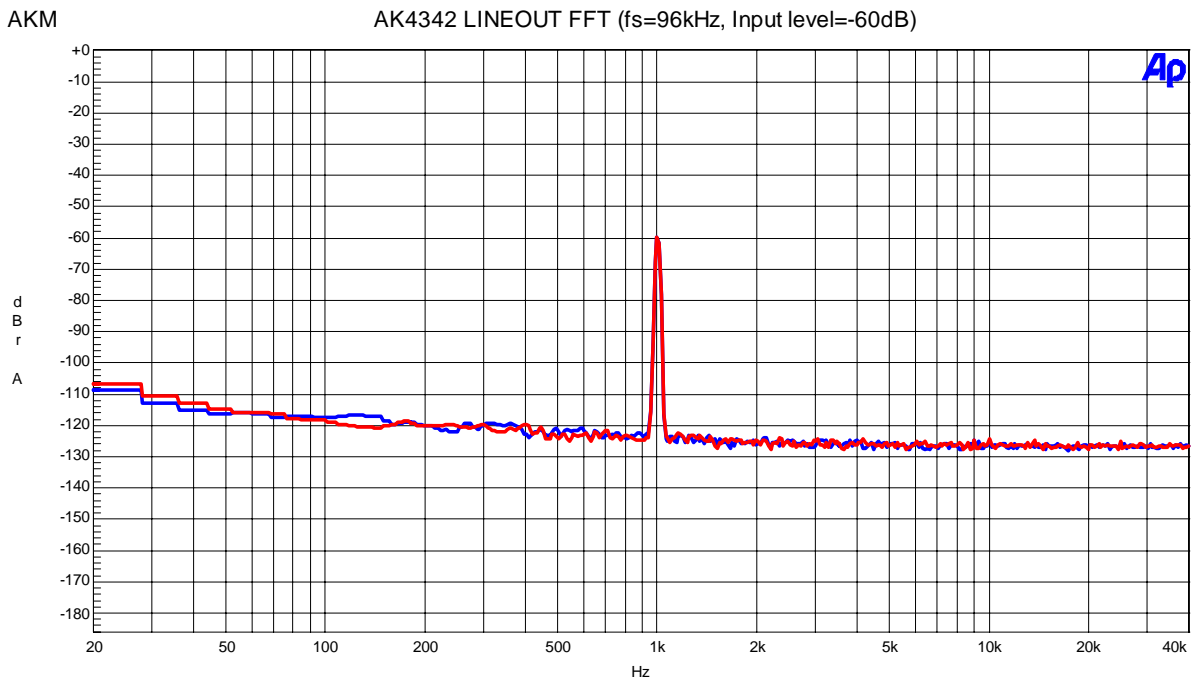

Figure 44. FFT Plot (1kHz,-60dB)

AK4342 HP-AMP FFT (Noise Floor)

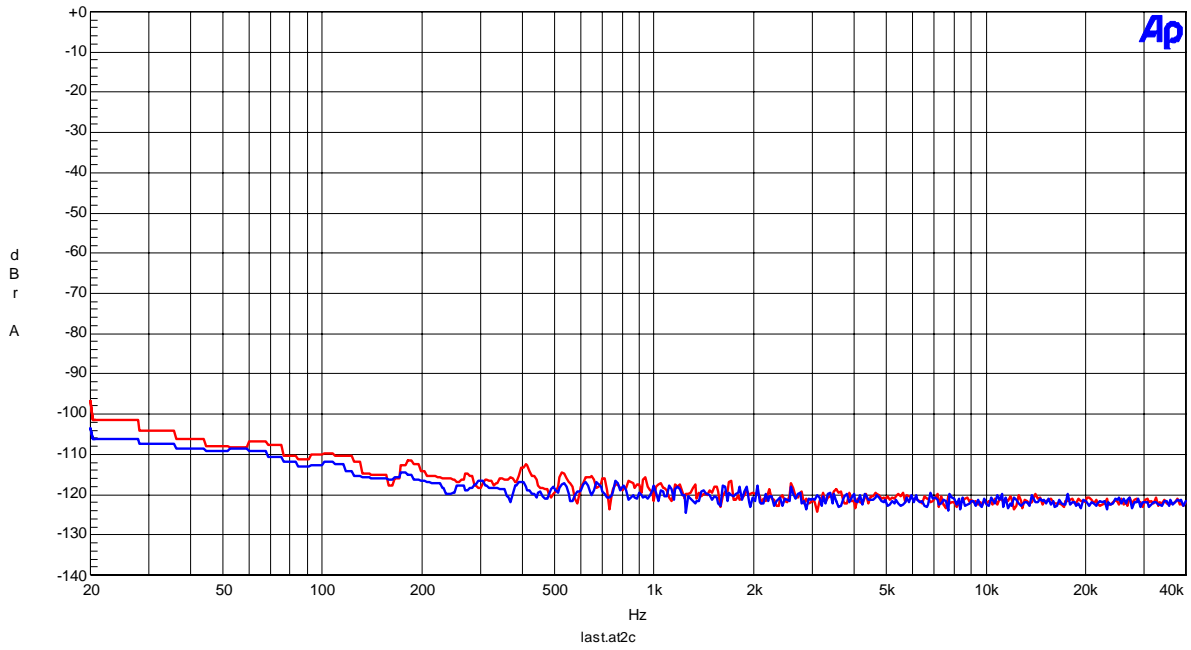

Figure 45. FFT Plot (Noise Floor)

AK4342 HP-AMP FFT (Out-band Noise)

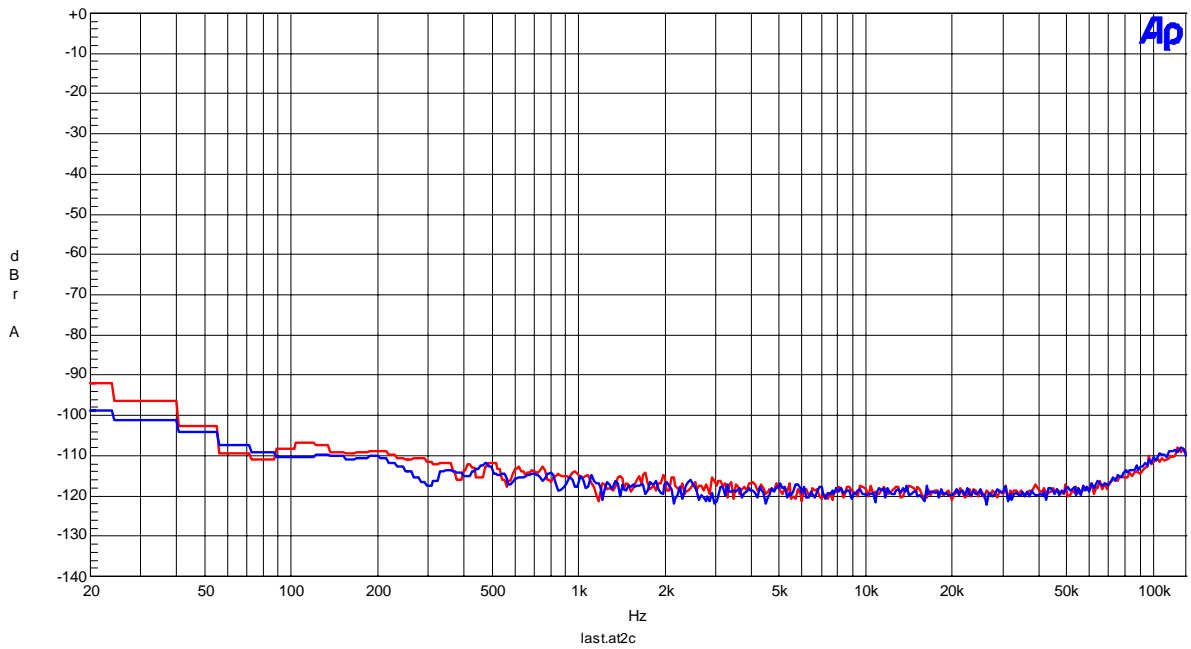

Figure 46. Out-of-band Noise

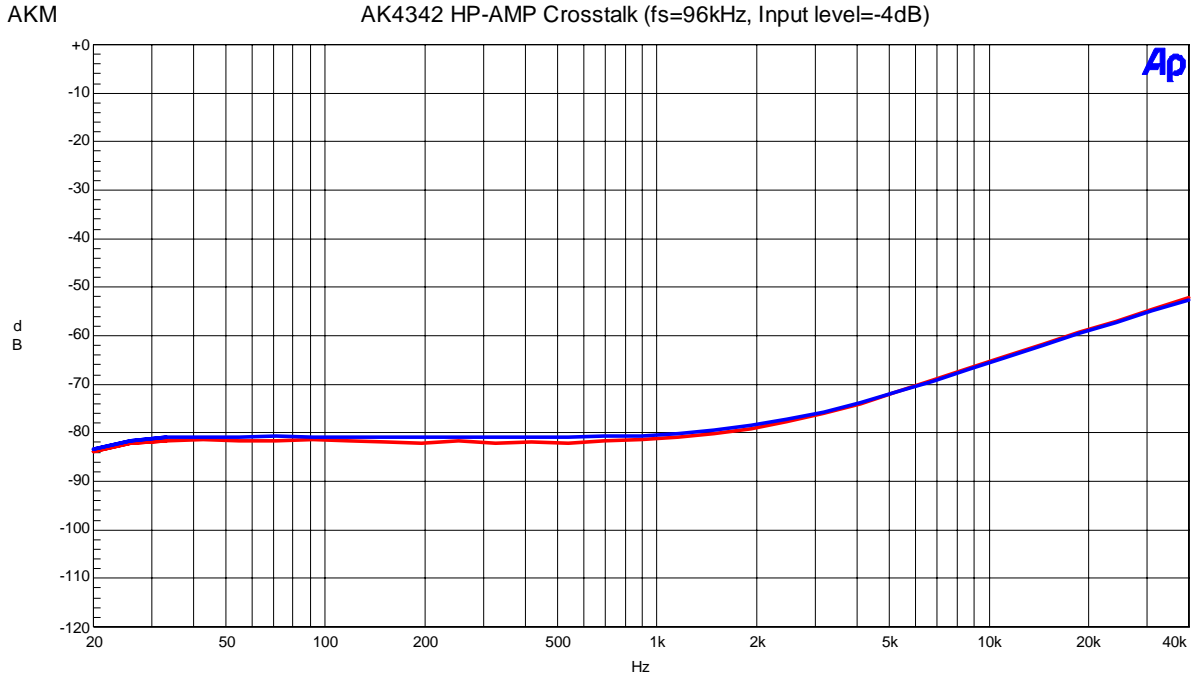

Figure 47. Crosstalk

[Plot of Lineout]

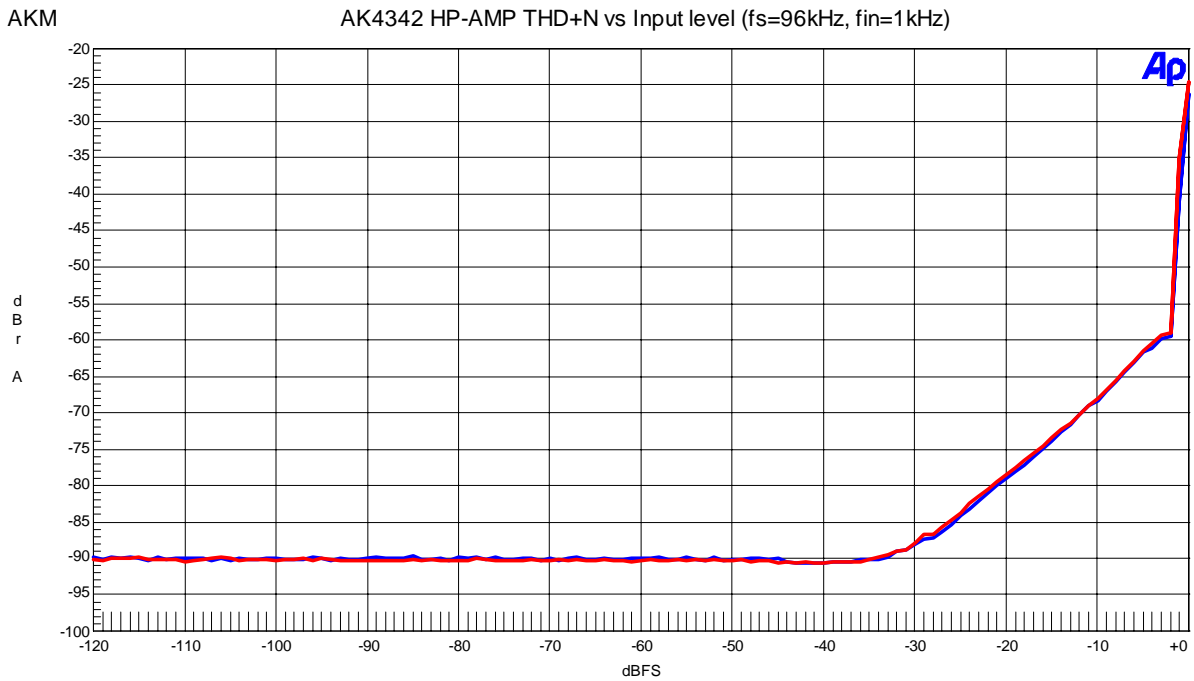

Figure 48. THD+N vs. Input level

AKM

AK4342 LINEOUT THD+N vs Input Frequency (fs=96kHz, Input level=0dB)

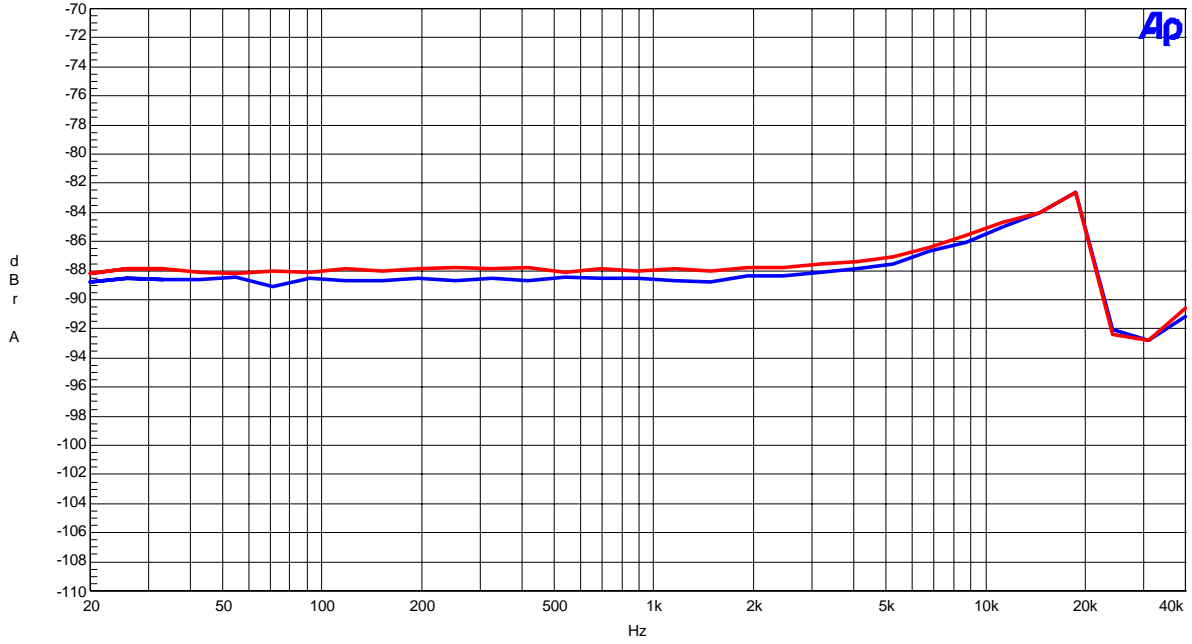

Figure 49. THD+N vs. Input Frequency

AK4342 LINEOUT Linearity (fs=96kHz, fin=1kHz)

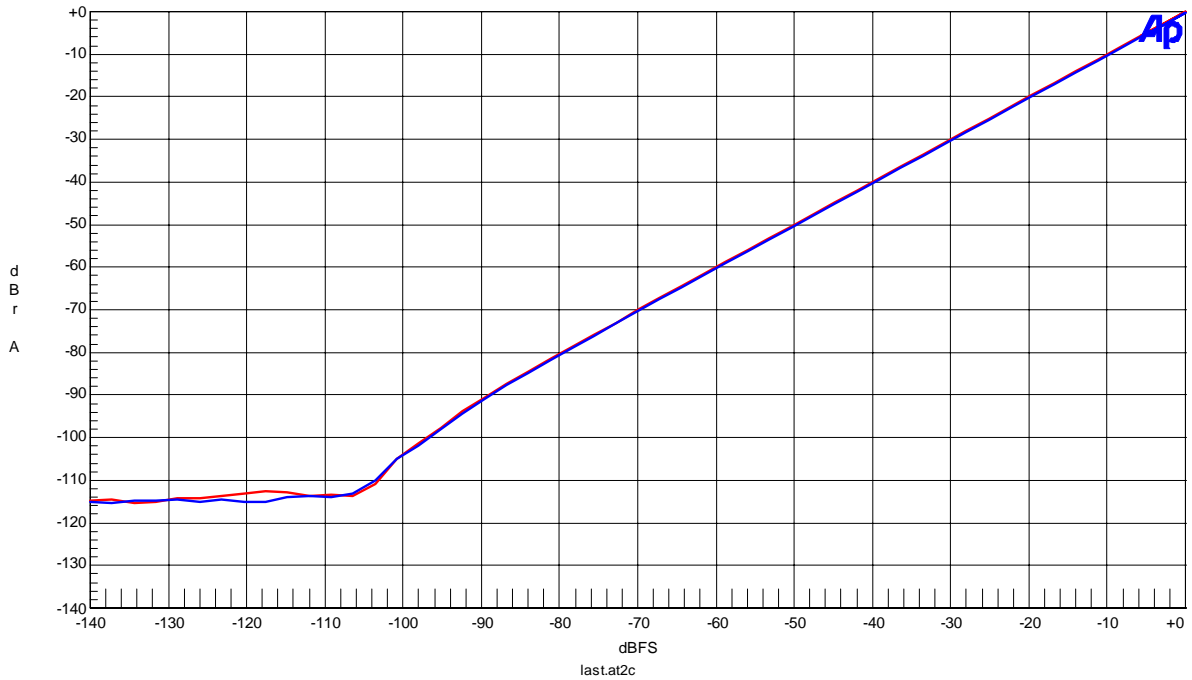

Figure 50. Linearity

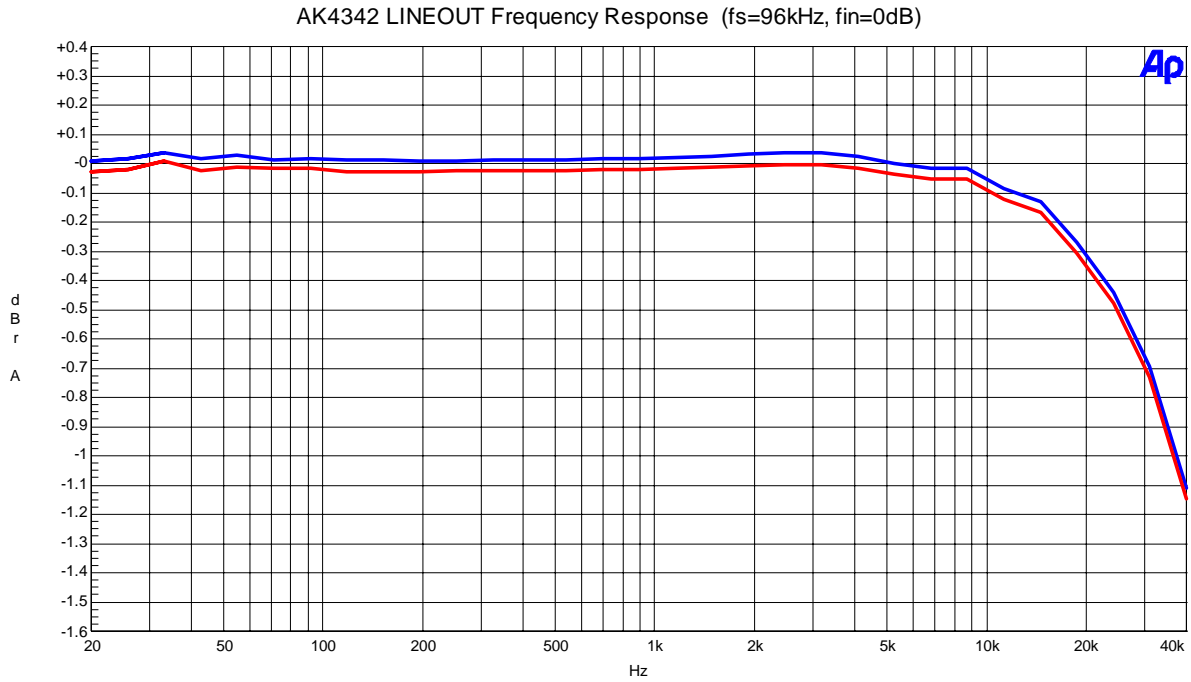

Figure 51. Frequency Response

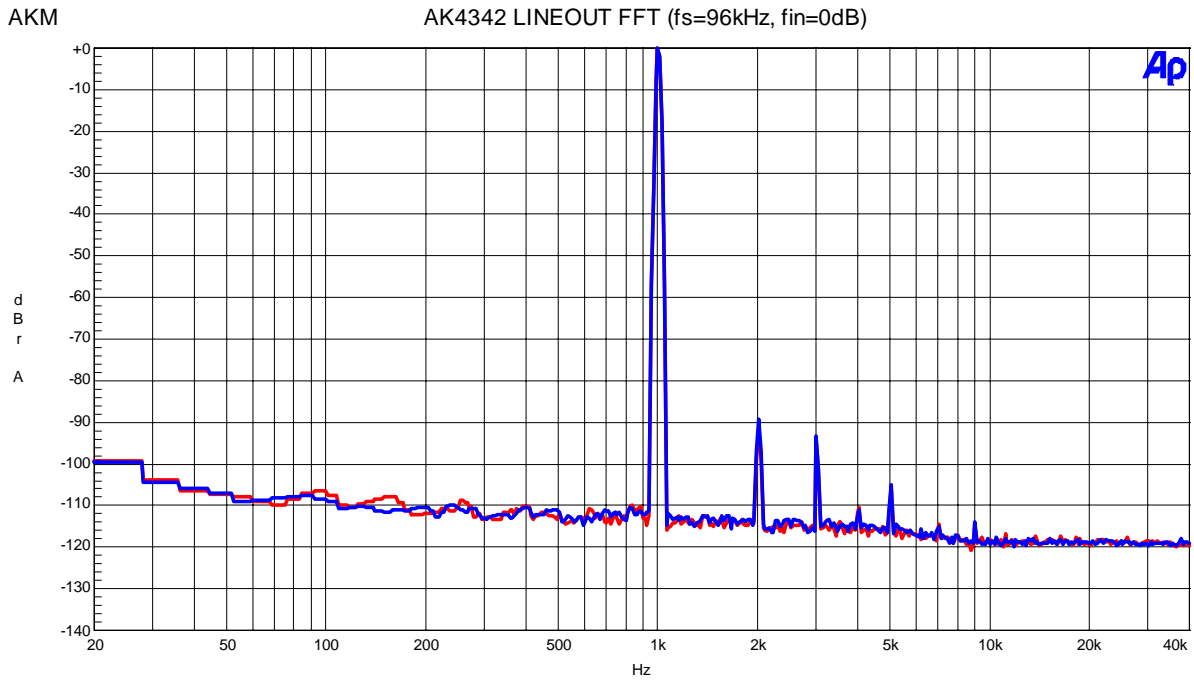

Figure 52. FFT Plot (1kHz, 0dBfs)

AKM

AK4342 LINEOUT FFT (fs=96kHz, Input level=-60dB)

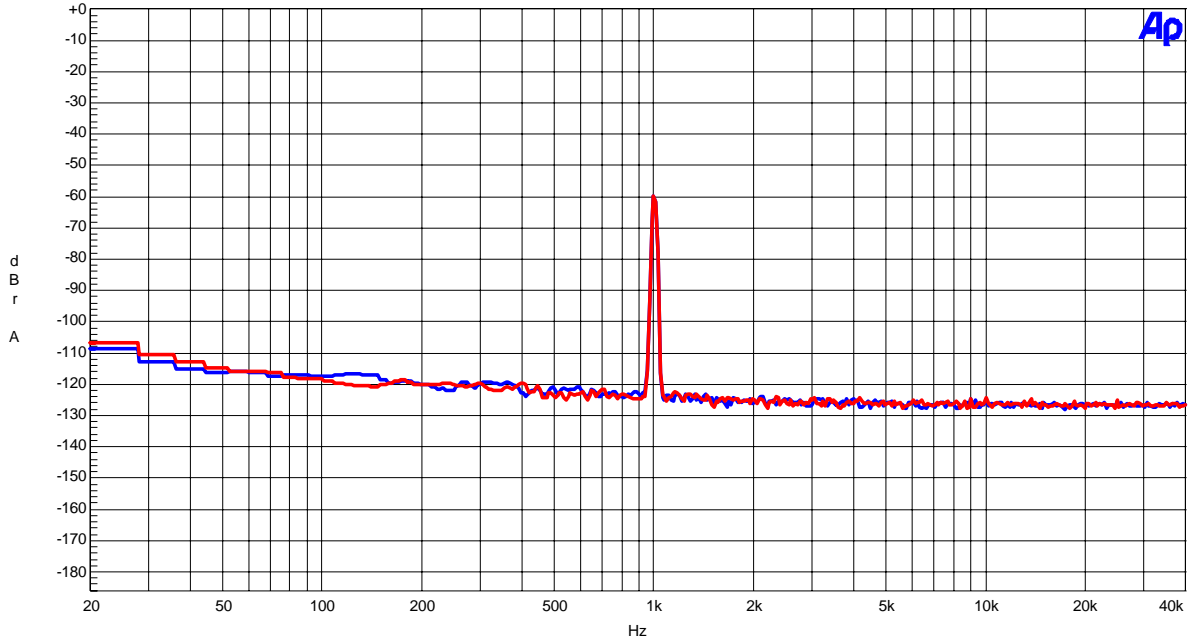

Figure 53. FFT Plot (1kHz, -60dBfs)

AK4342 LINEOUT FFT (Noise Floor)

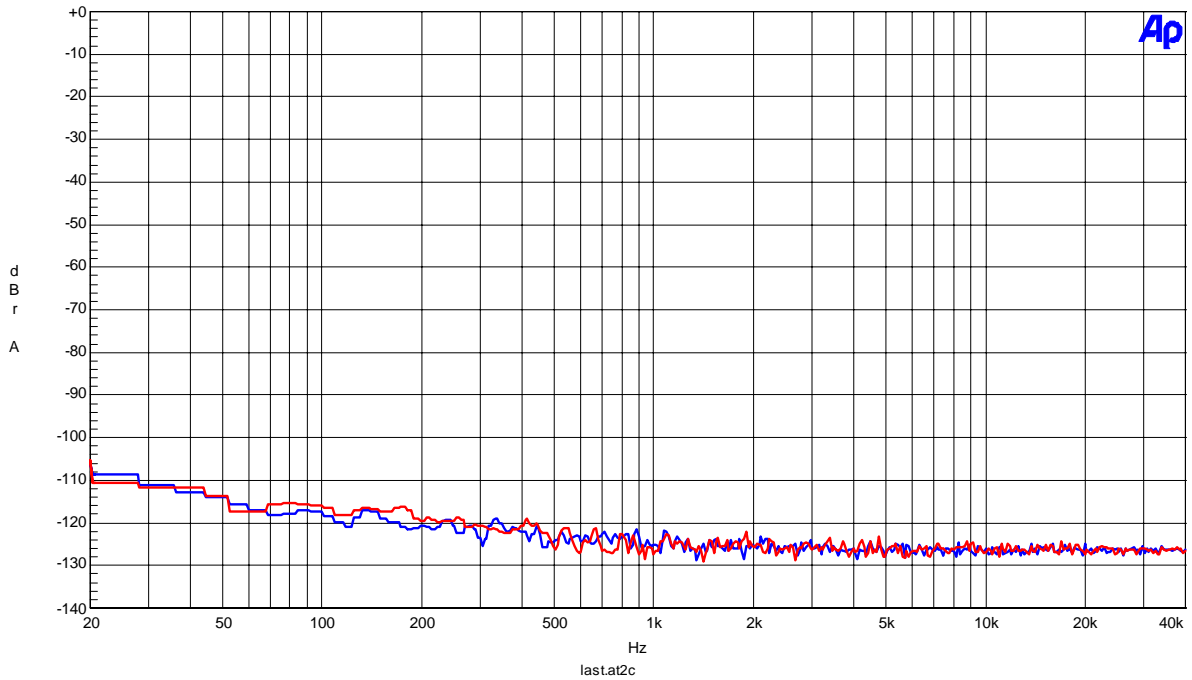

Figure 54. FFT Plot (Noise Floor)

AK4342 LINEOUT FFT (Out-band Noise)

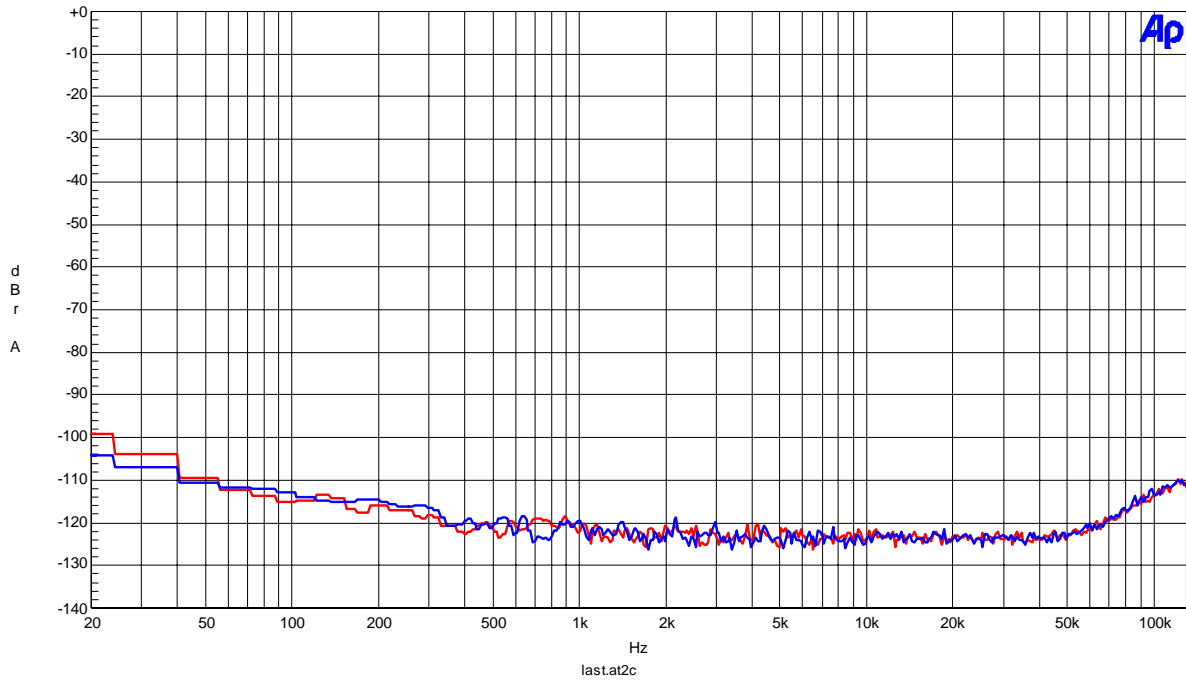

Figure 55. Out-of-band Noise

AK4342 LINEOUT Crosstalk (fs=96kHz, fin=0dB)

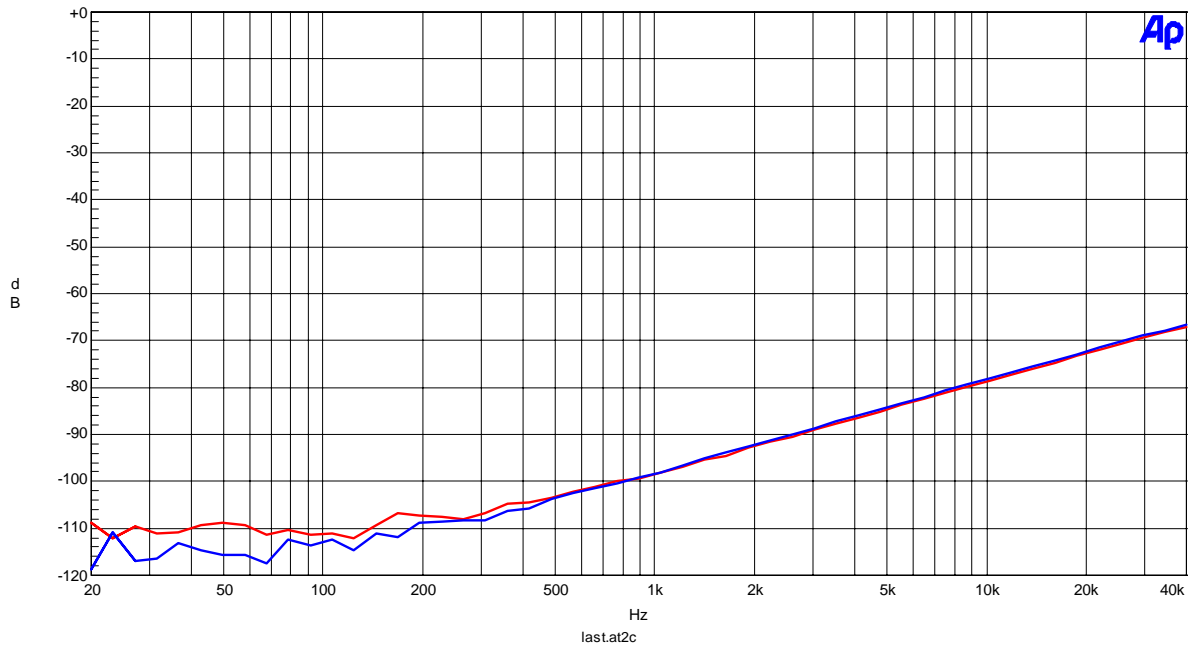

Figure 56. Crosstalk

[Plot of AUX]

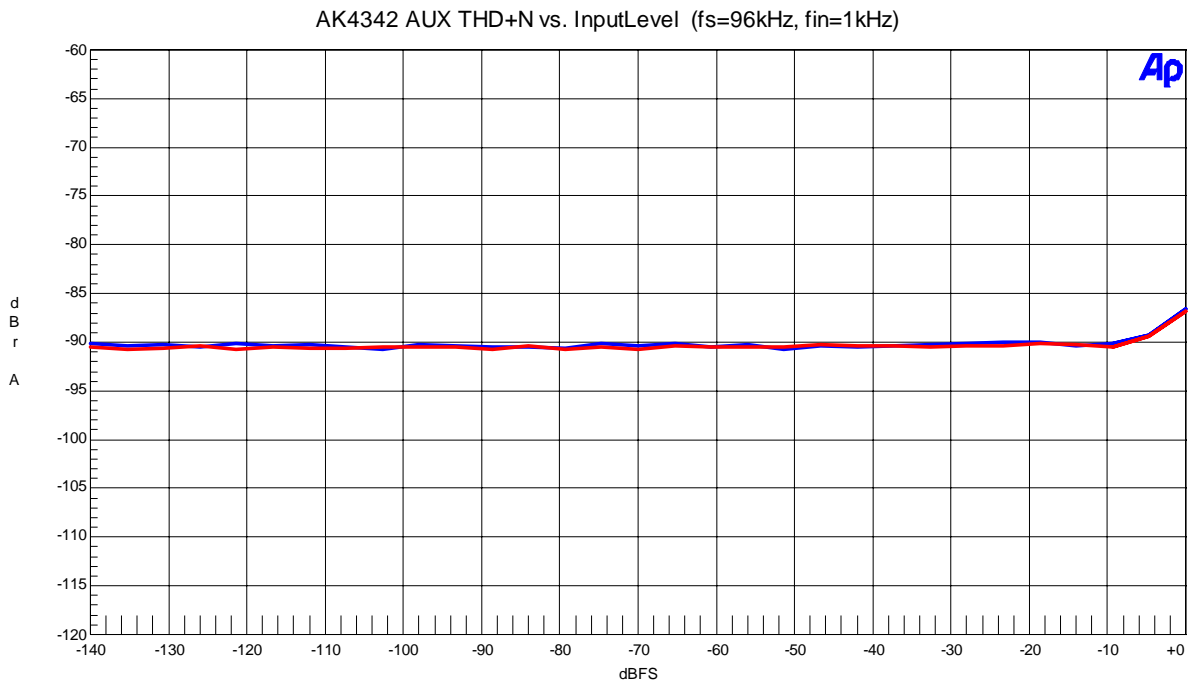

Figure 57. THD+N vs. Input Level

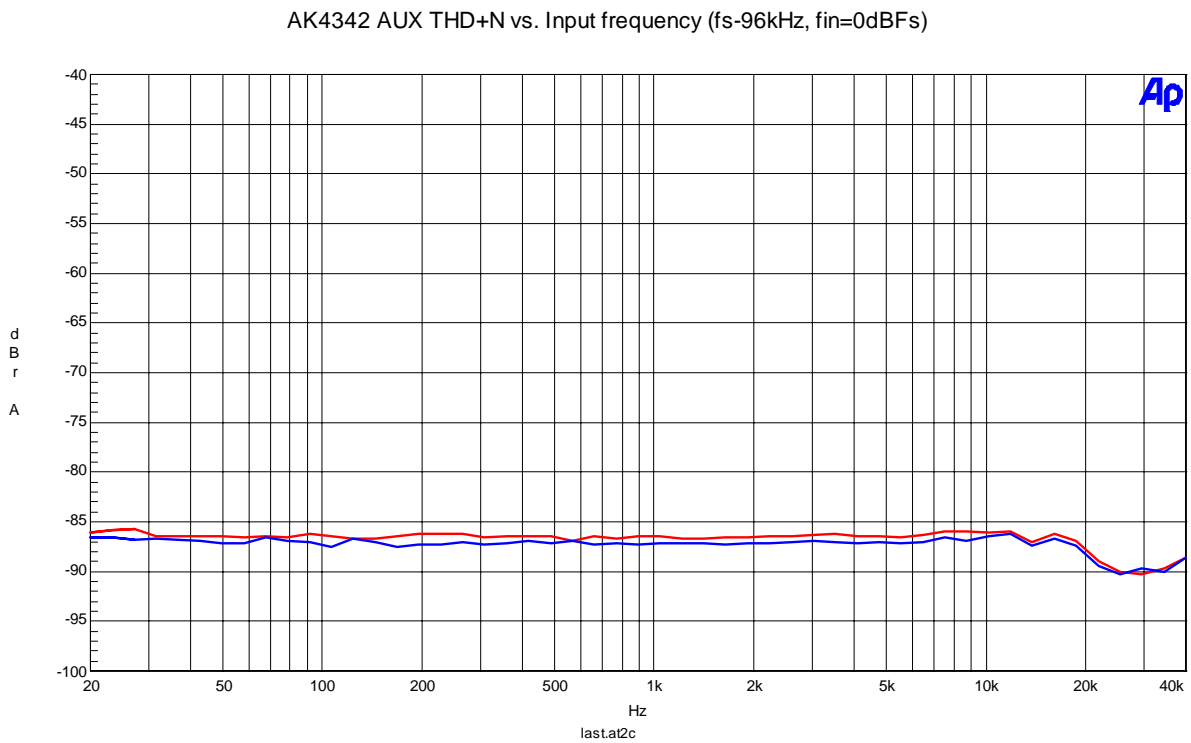

Figure 58. THD+N vs. Input Frequency

AK4342 AUX Linearity (fs=96kHz, fin=1kHz)

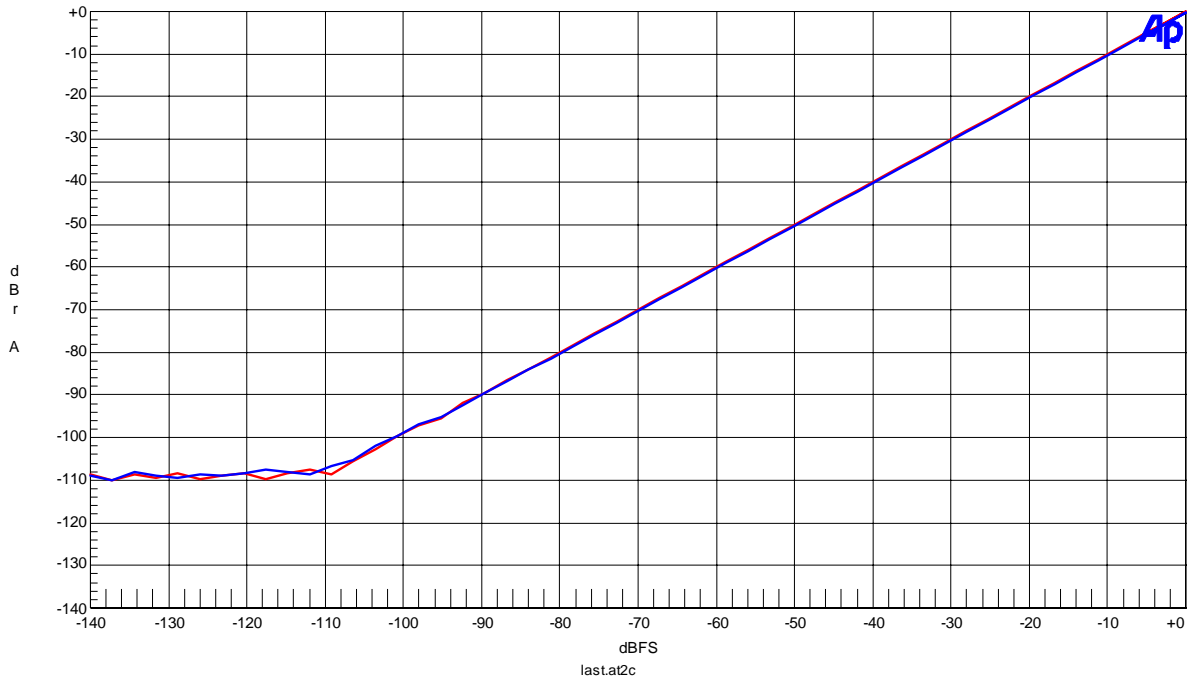

Figure 59. Linearity

AK4342 AUX Frequency Response (fs=96kHz, fin=0dB)

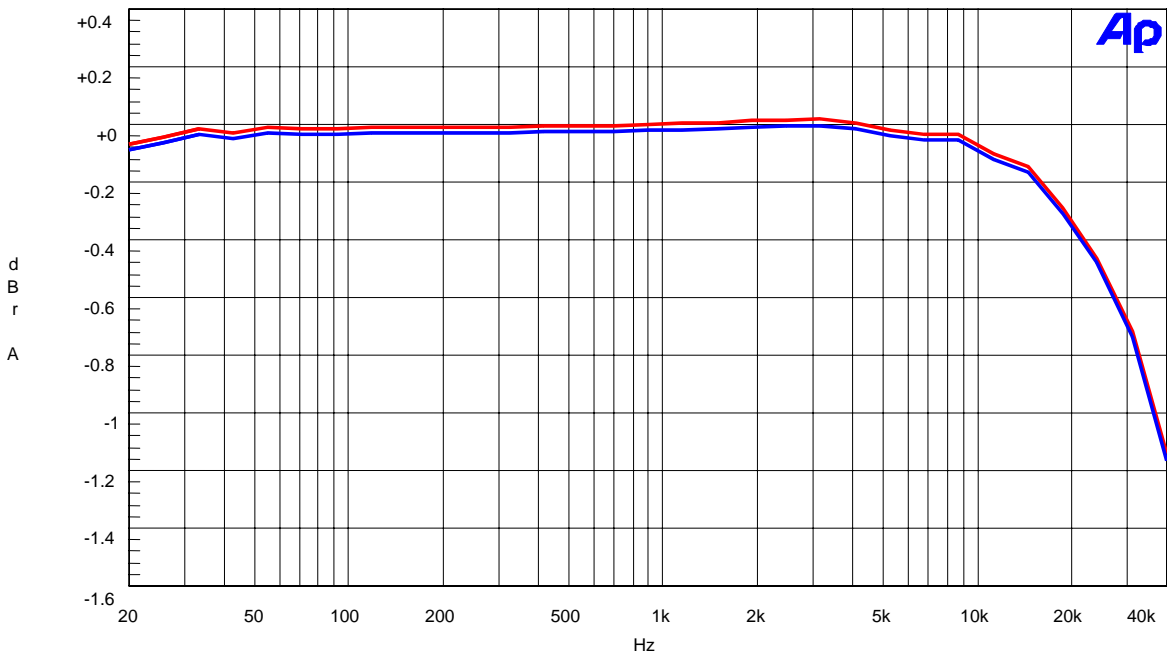

Figure 60. Frequency Response

AK4342 AUX FFT (fs=96kHz, fin=0dBfs)

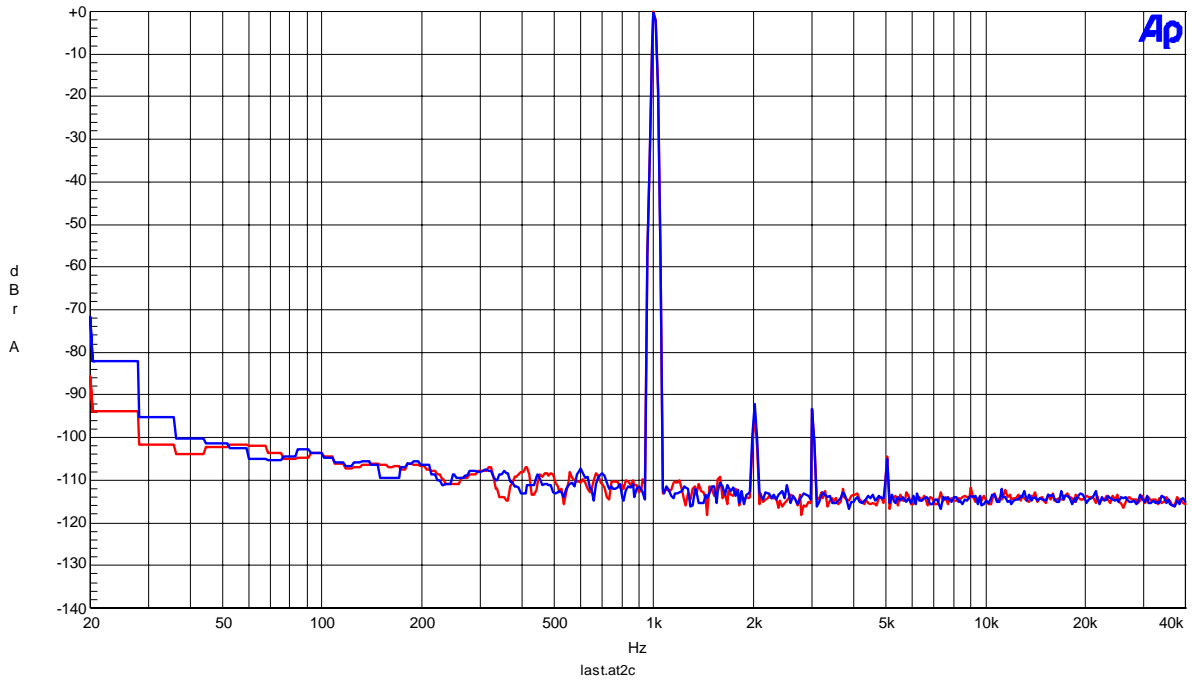

Figure 61. FFT Plot (1kHz, 0dB)

AK4342 AUX FFT (fs=96kHz, fin=-60dBfs)

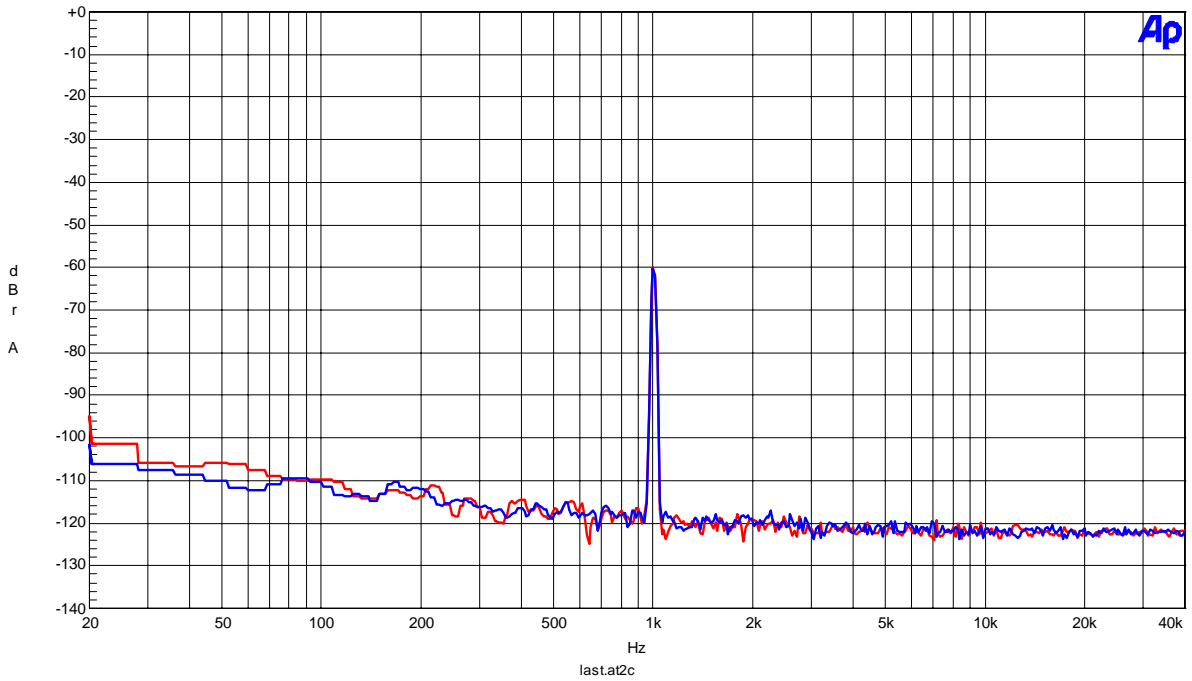

Figure 62. FFT Plot (1kHz, -60dB)

AK4342 AUX FFT (Noise Floor)

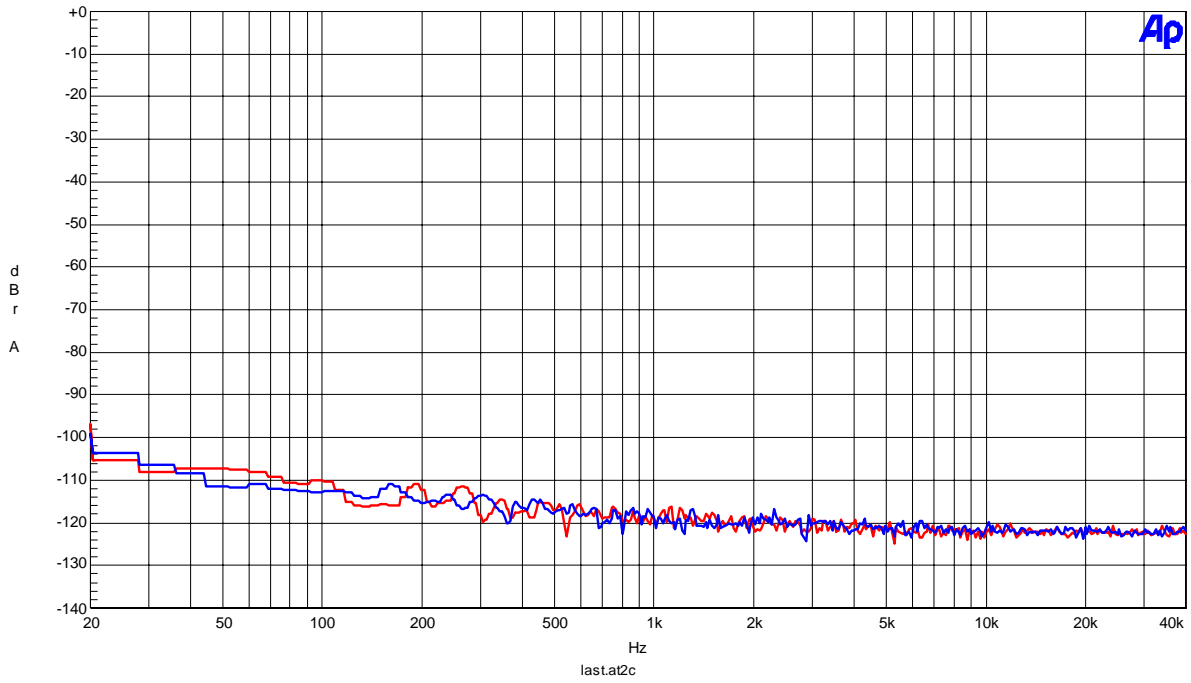

Figure 63. FFT Plot (Noise Floor)

AK4342 AUX FFT (Out-band Noise)

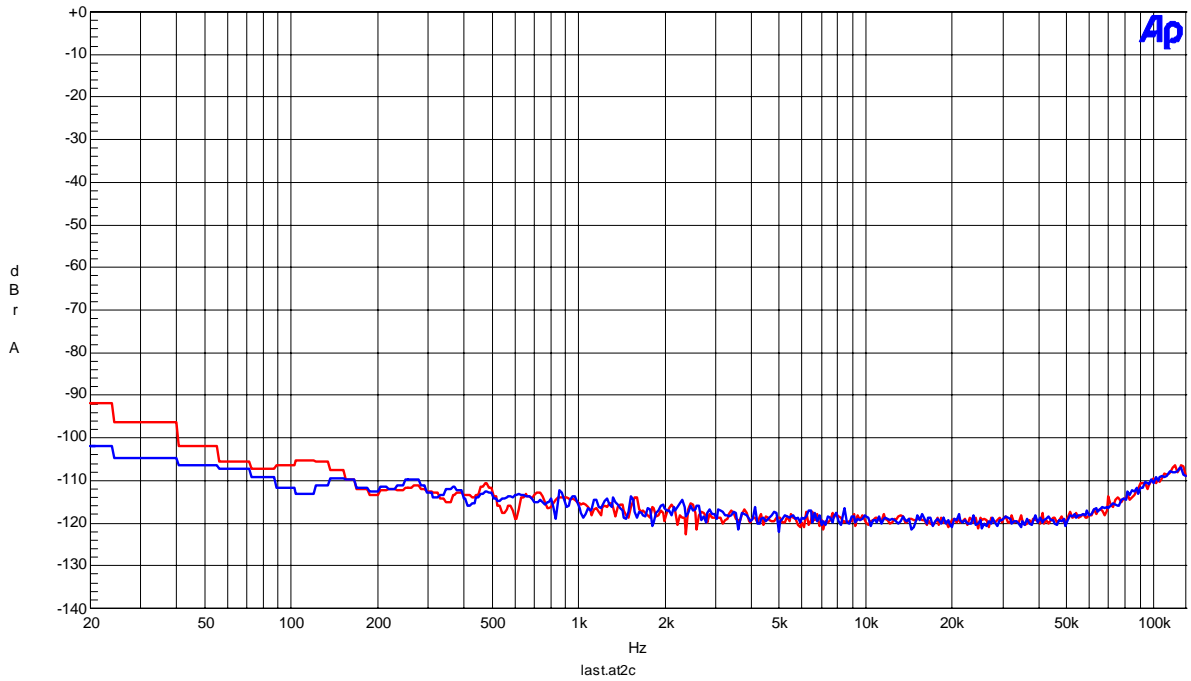

Figure 64. Out-of-band Noise

AK4342 AUX Crosstalk (fs=96kHz, fin=0dB)

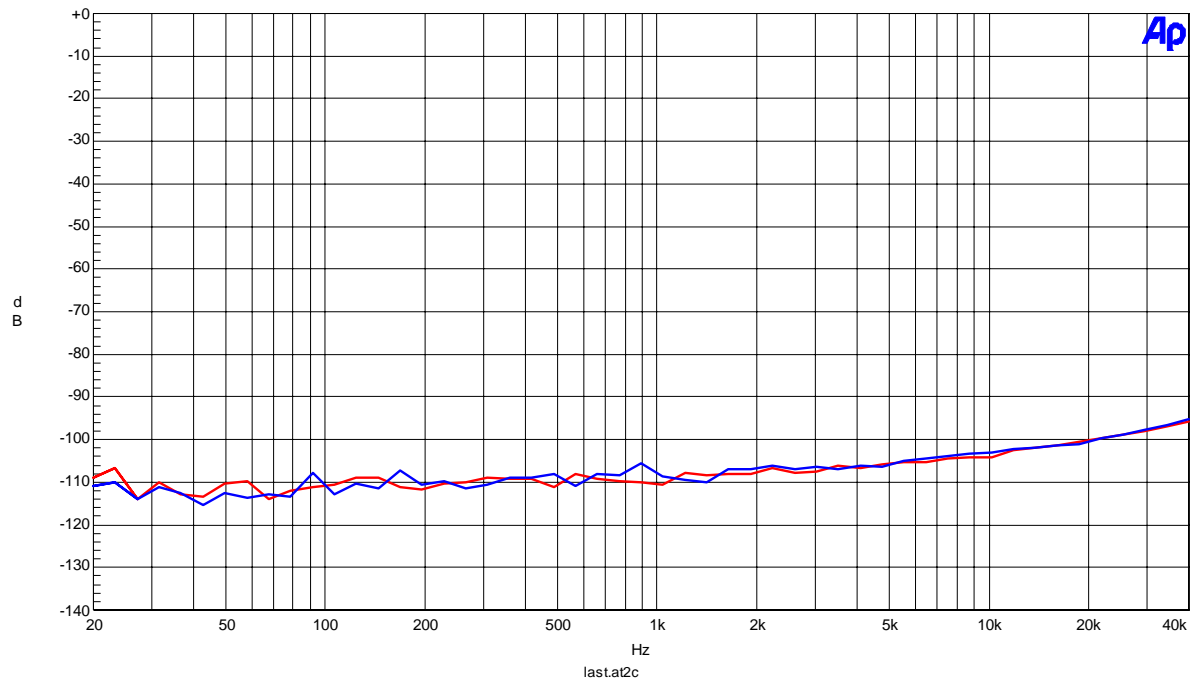
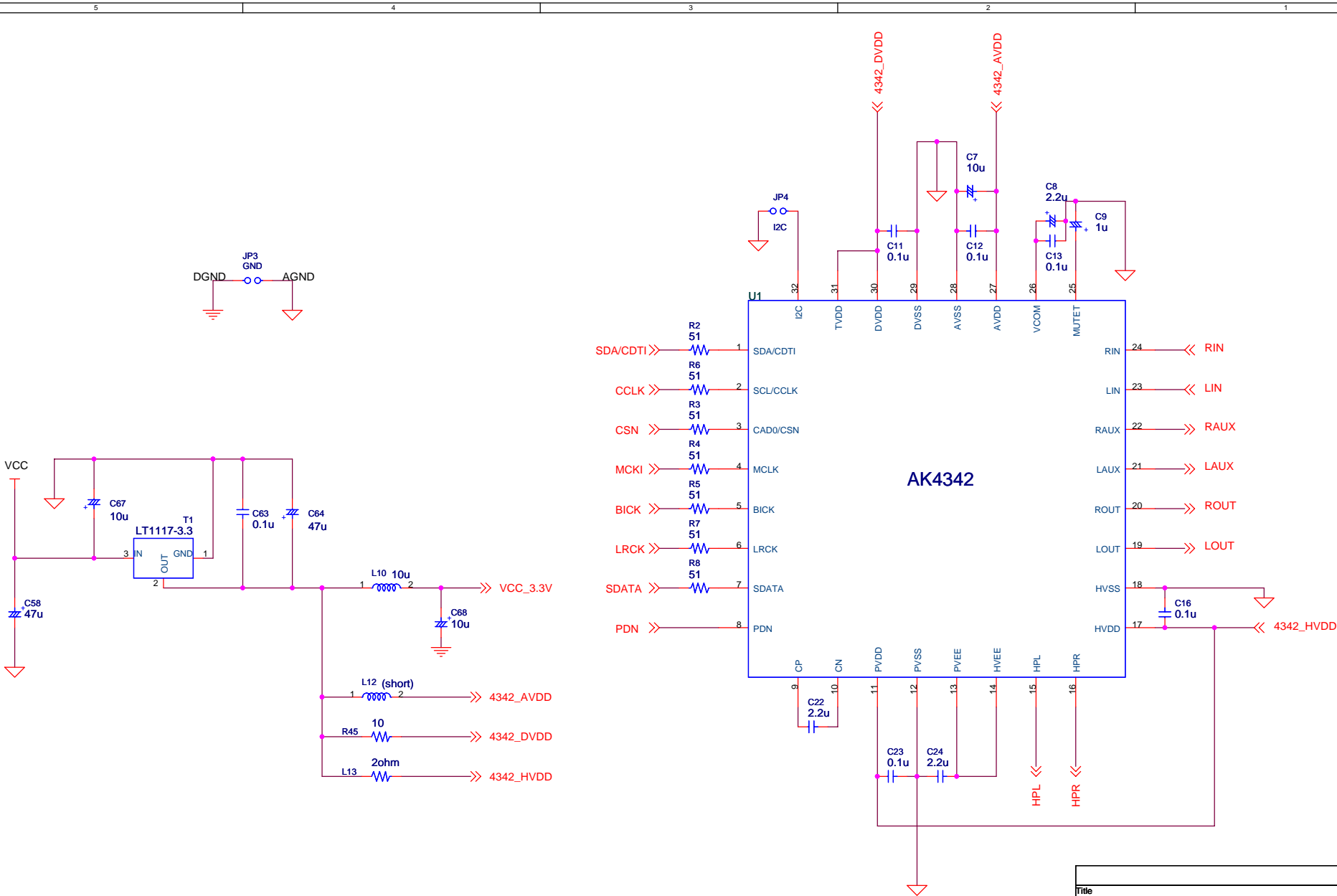

Figure 65. Crosstalk

Revision History				
Date	Manual Revision	Board Revision	Reason	Contents
06/01/12	KM081500	0	First Edition	
06/03/03	KM081501	1	Change circuit	L/ROUT output circuit of 5th page was changed. (C41, C42 : 2.2n → open)
			Change measurement result	Figure39, 57(Error correct) Figure24 and Figure51 were replaced because C41 and C42 were changed.
06/05/10	KM081502	2	Change circuit	C6, C17, C25 : 10u → open L3 : open → 2ohm
			Change measurement result and plot data	measurement result(P15) plot data change (Figure12, 13, 16, 17, 20, 21, 22, 25, 26, 29, 39, 40, 43, 44, 47, 48, 49, 52, 53)

IMPORTANT NOTICE

- These products and their specifications are subject to change without notice. Before considering any use or application, consult the Asahi Kasei Microsystems Co., Ltd. (AKM) sales office or authorized distributor concerning their current status.
- AKM assumes no liability for infringement of any patent, intellectual property, or other right in the application or use of any information contained herein.
- Any export of these products, or devices or systems containing them, may require an export license or other official approval under the law and regulations of the country of export pertaining to customs and tariffs, currency exchange, or strategic materials.
- AKM products are neither intended nor authorized for use as critical components in any safety, life support, or other hazard related device or system, and AKM assumes no responsibility relating to any such use, except with the express written consent of the Representative Director of AKM. As used here:
 - (a) A hazard related device or system is one designed or intended for life support or maintenance of safety or for applications in medicine, aerospace, nuclear energy, or other fields, in which its failure to function or perform may reasonably be expected to result in loss of life or in significant injury or damage to person or property.
 - (b) A critical component is one whose failure to function or perform may reasonably be expected to result, whether directly or indirectly, in the loss of the safety or effectiveness of the device or system containing it, and which must therefore meet very high standards of performance and reliability.
- It is the responsibility of the buyer or distributor of an AKM product who distributes, disposes of, or otherwise places the product with a third party to notify that party in advance of the above content and conditions, and the buyer or distributor agrees to assume any and all responsibility and liability for and hold AKM harmless from any and all claims arising from the use of said product in the absence of such notification.



Title		
AKD4342-B		
Size	Document Number	Rev
B	AK4342	2
Date:	Wednesday, May 10, 2006	Sheet 1 of 4

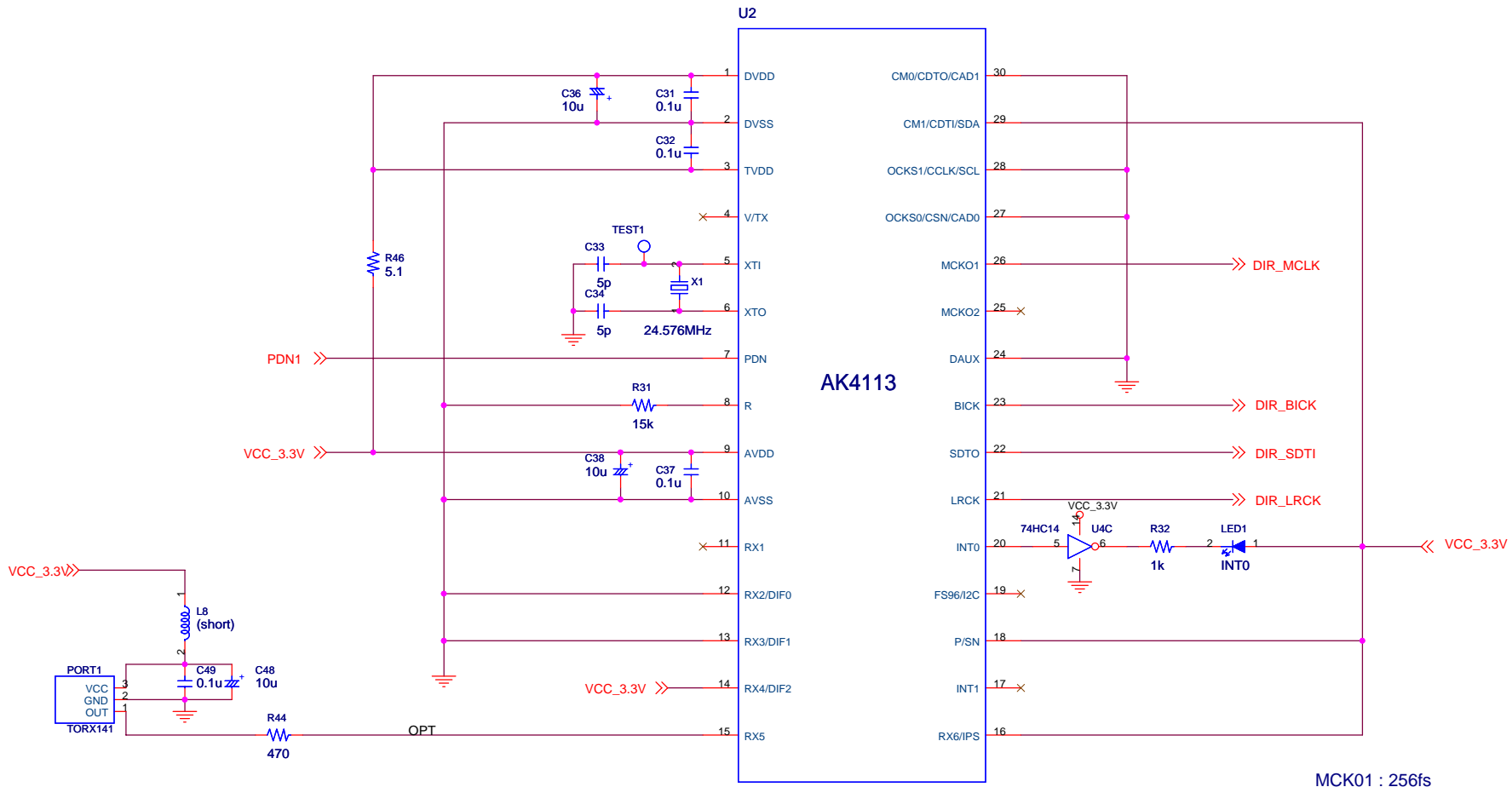

AK4113

MCKO1 : 256fs
 Clock Operation Mode : Mode2
 Audio Data Format : 24bit left justified

Title		
AKD4342-B		
Size B	Document Number	Rev 2
	DIR	
Date:	Wednesday, May 10, 2006	Sheet 2 of 4

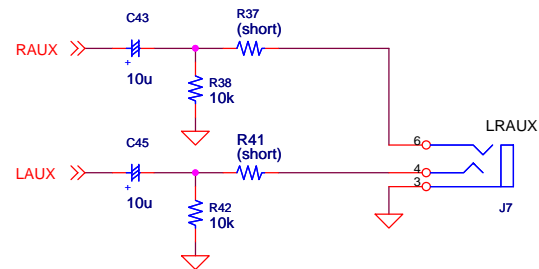
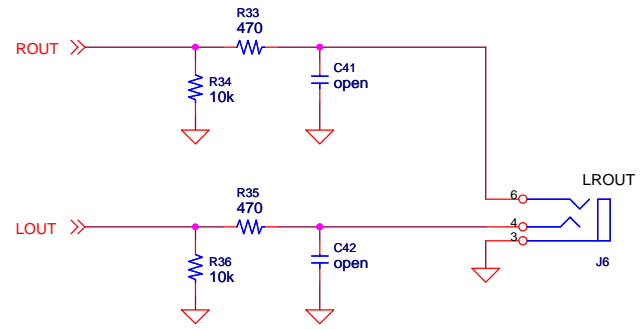
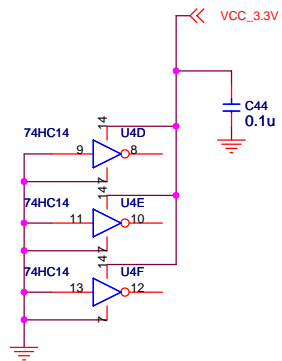
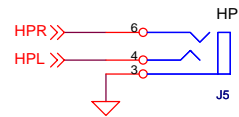
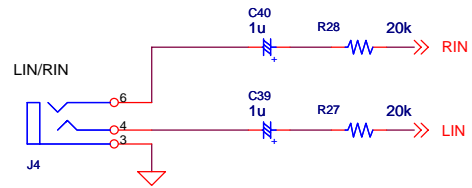

Title			AKD4342-B		
Size	Document Number				Rev
B	Input/Output				2
Date:	Wednesday, May 10, 2006		Sheet	3	of 4

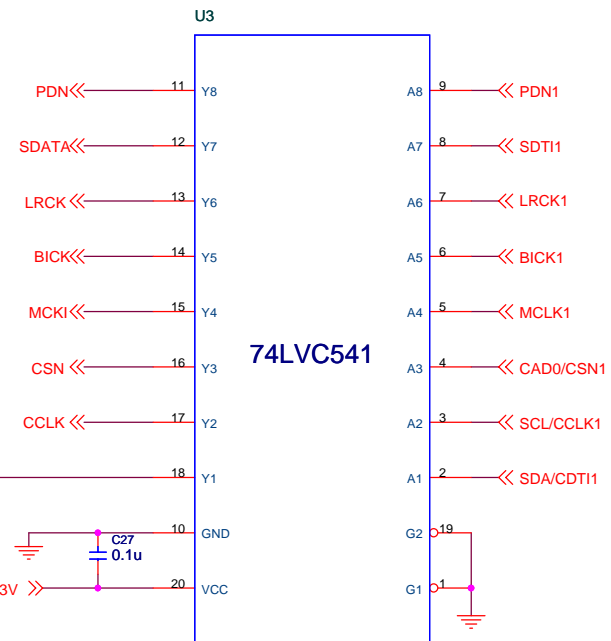
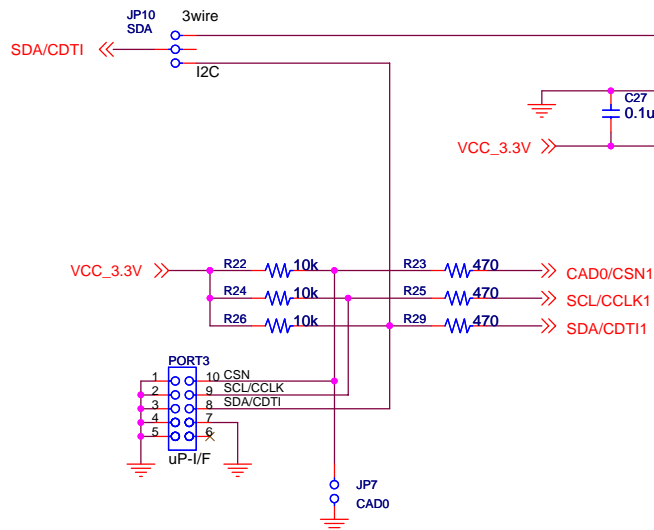
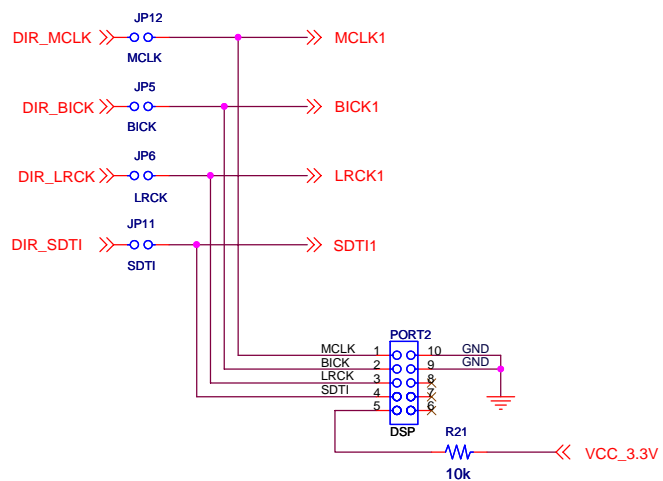
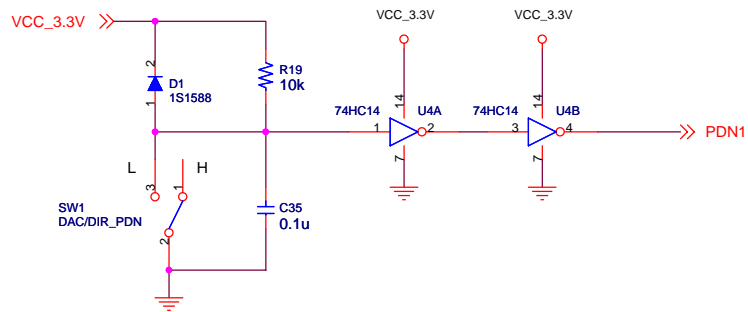

Title		
AKD4342-B		
Size	Document Number	Rev
B	Interface	2
Date:	Wednesday, May 10, 2006	Sheet 4 of 4

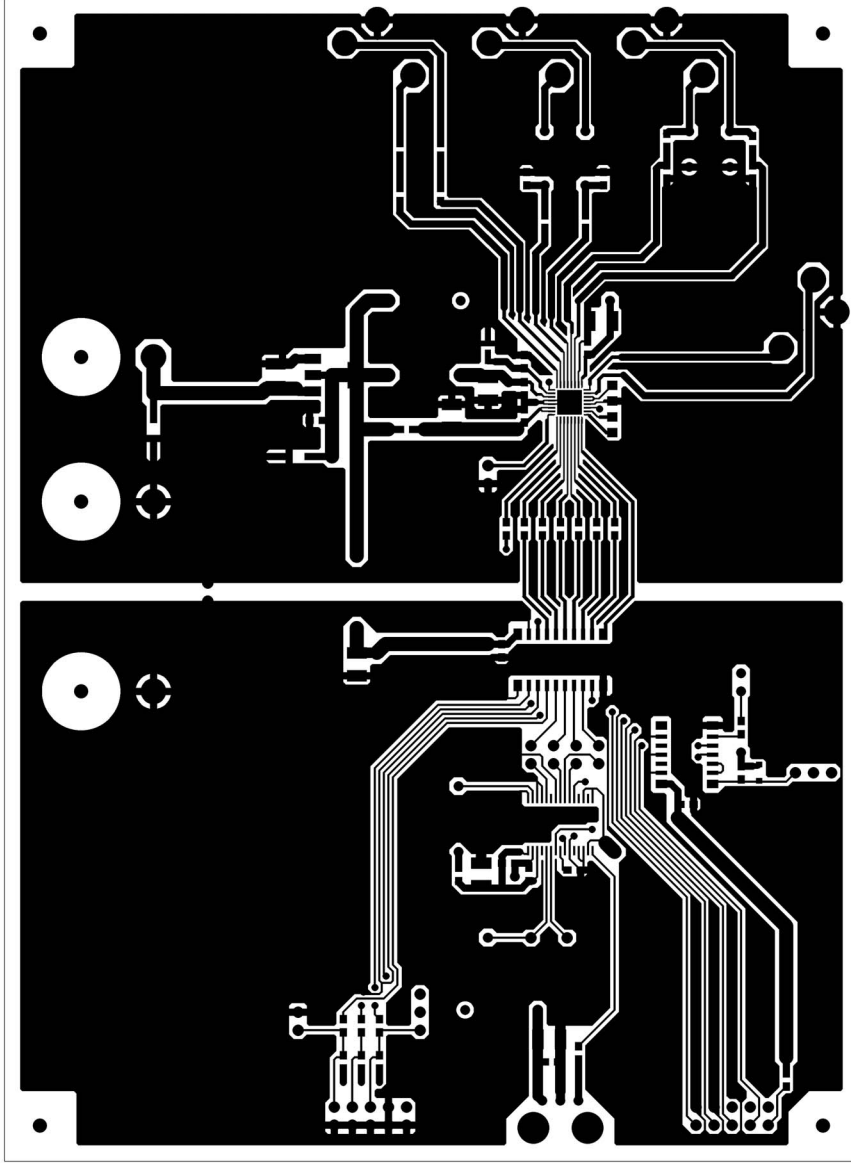

AKD4342-B REV.0
L1 PATTARN

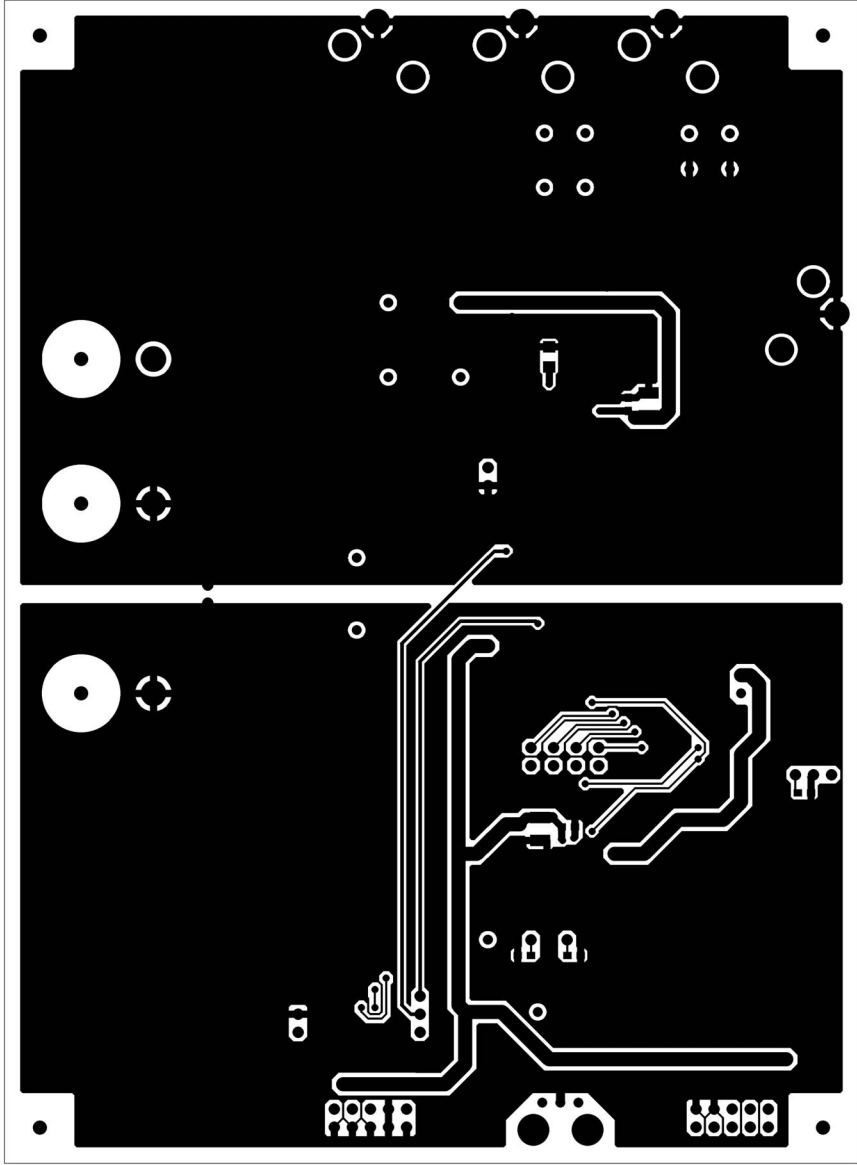

FS_PALLARI
VKD4345-B REV.0

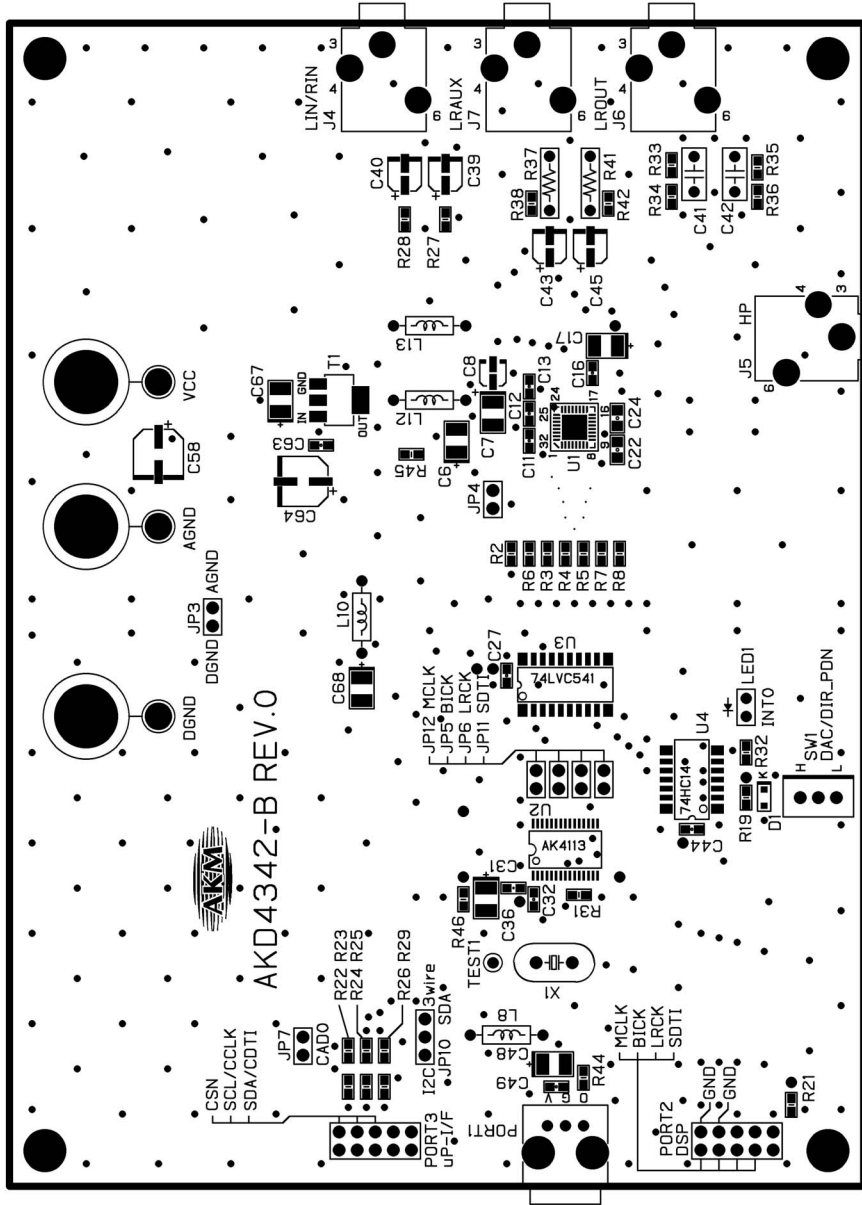

AKM
AKD4342-B REV.0

AKD4342-B REV.0
L1 SR L1 SILK

FS 2R FS 2ITK
VKD4345-B REV.0

