



# 5KP SERIES

## GLASS PASSIVATED JUNCTION TRANSIENT VOLTAGE SUPPRESSOR

**VOLTAGE** 5.0 to 200 Volts **PEAK PULSE POWER** 5000 Watts **P-600** Unit: inch(mm)

**RA** Recognized File # E210467

### FEATURES

- Plastic package has Underwriters Laboratory Flammability Classification 94V-O
- 5000W Peak Pulse Power capability at on 10/1000µs waveform
- Excellent clamping capability
- Low zener impedance
- Repetition rate(Duty Cycle):.05%
- Fast response time: typically less than 1.0 ps from 0 volts to BV min
- Typical IR less than 1µA above 10V
- In compliance with EU RoHS 2002/95/EC directives

### MECHANICAL DATA

- Case: JEDEC P-600 molded plastic
- Terminals: Axial leads, solderable per MIL-STD-750, Method 2026
- Polarity: Color band denoted cathode except Bipolar
- Mounting Position: Any
- Weight: 1.75 ounce, 0.0617 gram

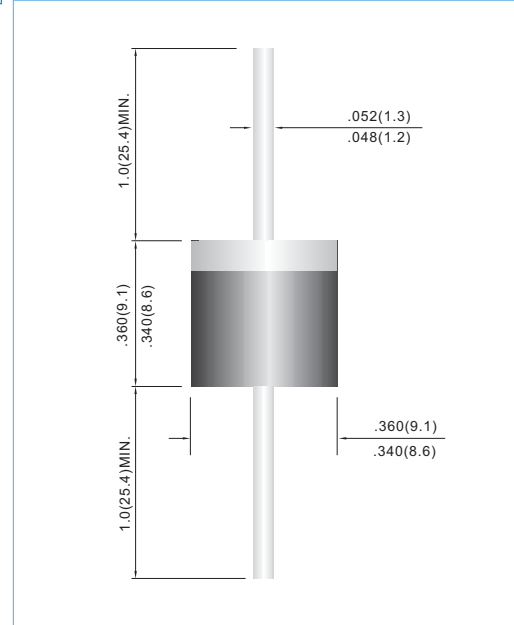

### DEVICES FOR BIPOLAR APPLICATIONS

For Bidirectional use C or CA Suffix for types 5KP5.0 thru types 5KP200  
Electrical characteristics apply in both directions.

### MAXIMUM RATINGS AND CHARACTERISTICS

Rating at 25°C ambient temperature unless otherwise specified.

Rating	Symbol	Value	Units
Peak Power Dissipation at $T_A=25^\circ\text{C}$ , $T_P=1\text{ms}$ (Note 1)	$P_{PK}$	5000	Watts
Steady State Power dissipation at $T_L = 75^\circ\text{C}$ Lead Lengths .375", (95mm) (Note 2)	$P_D$	8.0	Watts
Peak Forward Surge Current, 8.3ms Single Half Sine-Wave Superimposed on Rated Load (JECED Method) (Note 3)	$I_{FSM}$	400	Amps
Operating Junction and Storage Temperature Range	$T_J, T_{STG}$	-55 to +175	$^\circ\text{C}$

#### NOTES:

- 1.Non-repetitive current pulse, per Fig. 3 and derated above  $T_A=25^\circ\text{C}$  per Fig. 2.
- 2.Mounted on Copper Leaf area of 0.79in<sup>2</sup>(20mm<sup>2</sup>).
- 3.8.3ms single half sine-wave, duty cycle= 4 pulses per minutes maximum.



# 5KP SERIES

Part Number		V <sub>RRM</sub>	V <sub>BR</sub> @ I <sub>T</sub>			I <sub>r</sub> @ V <sub>RRM</sub>		V <sub>c</sub> @ I <sub>PP</sub>		Marking Code	
UNI-	BI-		Min. V	Max. V	I <sub>T</sub> mA	UNI- μA	BI- μA	V	A	UNI-	BI-
<b>5000W Transient Voltage Suppressor</b>											
5KP5.0	5KP5.0C	5	6.4	7.55	50	5000	10000	9.6	520	5KP5.0	5KP5.0C
5KP5.0A	5KP5.0CA	5	6.4	7.25	50	5000	10000	9.2	543	5KP5.0A	5KP5.0CA
5KP6.0	5KP6.0C	6	6.67	8.45	50	5000	10000	11.4	439	5KP6.0	5KP6.0C
5KP6.0A	5KP6.0CA	6	6.67	7.67	50	5000	10000	10.3	485	5KP6.0A	5KP6.0CA
5KP6.5	5KP6.5C	6.5	7.22	9.14	50	2000	4000	12.3	407	5KP6.5	5KP6.5C
5KP6.5A	5KP6.5CA	6.5	7.22	8.3	50	2000	4000	11.2	447	5KP6.5A	5KP6.5CA
5KP7.0	5KP7.0C	7	7.78	9.86	50	1000	2000	13.3	378	5KP7.0	5KP7.0C
5KP7.0A	5KP7.0CA	7	7.78	8.95	50	1000	2000	12	417	5KP7.0A	5KP7.0CA
5KP7.5	5KP7.5C	7.5	8.33	10.67	5	250	500	14.3	350	5KP7.5	5KP7.5C
5KP7.5A	5KP7.5CA	7.5	8.33	9.58	5	250	500	12.9	388	5KP7.5A	5KP7.5CA
5KP8.0	5KP8.0C	8	8.89	11.3	5	150	300	15	333	5KP8.0	5KP8.0C
5KP8.0A	5KP8.0CA	8	8.89	10.23	5	150	300	13.6	367	5KP8.0A	5KP8.0CA
5KP8.5	5KP8.5C	8.5	9.44	11.92	5	50	100	15.9	314	5KP8.5	5KP8.5C
5KP8.5A	5KP8.5CA	8.5	9.44	10.82	5	50	100	14.4	347	5KP8.5A	5KP8.5CA
5KP9.0	5KP9.0C	9	10	12.6	5	20	40	16.9	295	5KP9.0	5KP9.0C
5KP9.0A	5KP9.0CA	9	10	11.5	5	20	40	15.4	325	5KP9.0A	5KP9.0CA
5KP10	5KP10C	10	11.1	14.1	5	10	10	18.8	266	5KP10	5KP10C
5KP10A	5KP10CA	10	11.1	12.8	5	10	10	17	294	5KP10A	5KP10CA
5KP11	5KP11C	11	12.2	15.4	5	10	10	20.1	249	5KP11	5KP11C
5KP11A	5KP11CA	11	12.2	14	5	10	10	18.2	274	5KP11A	5KP11CA
5KP12	5KP12C	12	13.3	16.9	5	10	10	22	227	5KP12	5KP12C
5KP12A	5KP12CA	12	13.3	15.3	5	10	10	19.9	251	5KP12A	5KP12CA
5KP13	5KP13C	13	14.4	18.2	5	10	10	23.8	210	5KP13	5KP13C
5KP13A	5KP13CA	13	14.4	16.5	5	10	10	21.5	232	5KP13A	5KP13CA
5KP14	5KP14C	14	15.6	19.8	5	10	10	25.8	194	5KP14	5KP14C
5KP14A	5KP14CA	14	15.6	17.9	5	10	10	23.2	215	5KP14A	5KP14CA
5KP15	5KP15C	15	16.7	21.1	5	10	10	26.9	188	5KP15	5KP15C
5KP15A	5KP15CA	15	16.7	19.2	5	10	10	24.4	206	5KP15A	5KP15CA
5KP16	5KP16C	16	17.8	22.6	5	10	10	28.8	176	5KP16	5KP16C
5KP16A	5KP16CA	16	17.8	20.5	5	10	10	26	192	5KP16A	5KP16CA
5KPJ17	5KPJ17C	17	18.9	23.9	5	10	10	30.5	164	5KPJ17	5KPJ17C
5KP17A	5KP17CA	17	18.9	21.7	5	10	10	27.6	181	5KP17A	5KP17CA
5KP18	5KP18C	18	20	25.3	5	10	10	32.2	155	5KP18	5KP18C
5KP18A	5KP18CA	18	20	23.3	5	10	10	29.2	172	5KP18A	5KP18CA
5KP20	5KP20C	20	22.2	28.1	5	10	10	35.8	139	5KP20	5KP20C
5KP20A	5KP20CA	20	22.2	25.5	5	10	10	32.4	154	5KP20A	5KP20CA
5KP22	5KP22C	22	24.4	30.9	5	10	10	39.4	127	5KP22	5KP22C
5KP22A	5KP22CA	22	24.4	28	5	10	10	35.5	141	5KP22A	5KP22CA
5KP24	5KP24C	24	26.7	33.8	5	10	10	43	116	5KP24	5KP24C
5KP24A	5KP24CA	24	26.7	30.7	5	10	10	38.9	128	5KP24A	5KP24CA
5KP26	5KP26C	26	28.9	36.6	5	10	10	46.6	107	5KP26	5KP26C
5KP26A	5KP26CA	26	28.9	33.2	5	10	10	42.1	119	5KP26A	5KP26CA
5KP28	5KP28C	28	31.1	39.4	5	10	10	50	99	5KP28	5KP28C
5KP28A	5KP28CA	28	31.1	35.8	5	10	10	45.4	110	5KP28A	5KP28CA
5KP30	5KP30C	30	33.3	42.2	5	10	10	53.5	93	5KP30	5KP30C
5KP30A	5KP30CA	30	33.3	38.3	5	10	10	48.4	103	5KP30A	5KP30CA
5KP33	5KP33C	33	36.7	46.5	5	10	10	59	85	5KP33	5KP33C
5KP33A	5KP33CA	33	36.7	42.2	5	10	10	53.3	94	5KP33A	5KP33CA
5KP36	5KP36C	36	40	50.7	5	10	10	64.3	78	5KP36	5KP36C
5KP36A	5KP36CA	36	40	46	5	10	10	58.1	85	5KP36A	5KP36CA
5KP40	5KP40C	40	44.4	56.3	5	10	10	71.4	70	5KP40	5KP40C
5KP40A	5KP40CA	40	44.4	51.1	5	10	10	64.5	78	5KP40A	5KP40CA



# 5KP SERIES

Part Number		V <sub>RWM</sub>	V <sub>BR</sub> @ I <sub>T</sub>			I <sub>R</sub> @ V <sub>RWM</sub>		V <sub>C</sub> @ I <sub>PP</sub>		Marking Code	
			Min.	Max.	I <sub>T</sub>	UNI-	BI-	V	A	UNI-	BI-
UNI-	BI-	V	V	V	mA	µA	µA	V	A	UNI-	BI-
<b>5000W Transient Voltage Suppressor</b>											
5KP43	5KP43C	43	47.8	60.5	5	10	10	76.7	65	5KP43	5KP43C
5KP43A	5KP43CA	43	47.8	54.9	5	10	10	69.4	72	5KP43A	5KP43CA
5KP45	5KP45C	45	50	63.3	5	10	10	80.3	62	5KP45	5KP45C
5KP45A	5KP45CA	45	50	57.5	5	10	10	72.7	69	5KP45A	5KP45CA
5KP48	5KP48C	48	53.3	67.5	5	10	10	85.5	58	5KP48	5KP48C
5KP48A	5KP48CA	48	53.3	61.3	5	10	10	77.4	65	5KP48A	5KP48CA
5KP51	5KP51C	51	56.7	71.8	5	10	10	91.1	55	5KP51	5KP51C
5KP51A	5KP51CA	51	56.7	65.2	5	10	10	82.4	61	5KP51A	5KP51CA
5KP54	5KP54C	54	60	76	5	10	10	96.3	52	5KP54	5KP54C
5KP54A	5KP54CA	54	60	69	5	10	10	87.1	57	5KP54A	5KP54CA
5KP58	5KP58C	58	64.4	81.6	5	10	10	103	49	5KP58	5KP58C
5KP58A	5KP58CA	58	64.4	74.1	5	10	10	93.6	53	5KP58A	5KP58CA
5KP60	5KP60C	60	66.7	84.5	5	10	10	107	47	5KP60	5KP60C
5KP60A	5KP60CA	60	66.7	76.7	5	10	10	96.8	52	5KP60A	5KP60CA
5KP64	5KP64C	64	71.1	90.1	5	10	10	114	44	5KP64	5KP64C
5KP64A	5KP64CA	64	71.1	81.8	5	10	10	103	49	5KP64A	5KP64CA
5KP70	5KP70C	70	77.8	98.6	5	10	10	125	40	5KP70	5KP70C
5KP70A	5KP70CA	70	77.8	89.5	5	10	10	113	44	5KP70A	5KP70CA
5KP75	5KP75C	75	83.3	105.7	5	10	10	134	37	5KP75	5KP75C
5KP75A	5KP75CA	75	83.3	95.8	5	10	10	121	41	5KP75A	5KP75CA
5KP78	5KP78C	78	86.7	109.8	5	10	10	139	36	5KP78	5KP78C
5KP78A	5KP78CA	78	86.7	99.7	5	10	10	126	40	5KP78A	5KP78CA
5KP85	5KP85C	85	94.4	119.2	5	10	10	151	33	5KP85	5KP85C
5KP85A	5KP85CA	85	94.4	108.2	5	10	10	137	36	5KP85A	5KP85CA
5KP90	5KP90C	90	100	126.5	5	10	10	160	31	5KP90	5KP90C
5KP90A	5KP90CA	90	100	115.5	5	10	10	146	34	5KP90A	5KP90CA
5KP100	5KP100C	100	111	141	5	10	10	179	28	5KP100	5KP100C
5KP100A	5KP100CA	100	111	128	5	10	10	162	31	5KP100A	5KP100CA
5KP110	5KP110C	110	122	154.5	5	10	10	196	26	5KP110	5KP110C
5KP110A	5KP110CA	110	122	140.5	5	10	10	177	28	5KP110A	5KP110CA
5KP120	5KP120C	120	133	169	5	10	10	214	23	5KP120	5KP120C
5KP120A	5KP120CA	120	133	153	5	10	10	193	20	5KP120A	5KP120CA
5KP130	5KP130C	130	144	182.5	5	10	10	231	22	5KP130	5KP130C
5KP130A	5KP130CA	130	144	165.5	5	10	10	209	24	5KP130A	5KP130CA
5KP150	5KP150C	150	167	211.5	5	10	10	268	19	5KP150	5KP150C
5KP150A	5KP150CA	150	167	192.5	5	10	10	243	21	5KP150A	5KP150CA
5KP160	5KP160C	160	178	226	5	10	10	287	17	5KP160	5KP160C
5KP160A	5KP160CA	160	178	205	5	10	10	259	19	5KP160A	5KP160CA
5KP170	5KP170C	170	189	239.5	5	10	10	304	16	5KP170	5KP170C
5KP170A	5KP170CA	170	189	217.5	5	10	10	275	18	5KP170A	5KP170CA
5KP180	5KP180C	180	198	253.8	1	5	5	322	16	5KP180	5KP180C
5KP180A	5KP180CA	180	198	230.4	1	5	5	292	17	5KP180A	5KP180CA
5KP190	5KP190C	190	209	267.9	1	5	5	340	15	5KP190	5KP190C
5KP190A	5KP190CA	190	209	243.2	1	5	5	308	16	5KP190A	5KP190CA
5KP200	5KP200C	200	220	282	1	5	5	358	14	5KP200	5KP200C
5KP200A	5KP200CA	200	220	256	1	5	5	324	15	5KP200A	5KP200CA



# 5KP SERIES

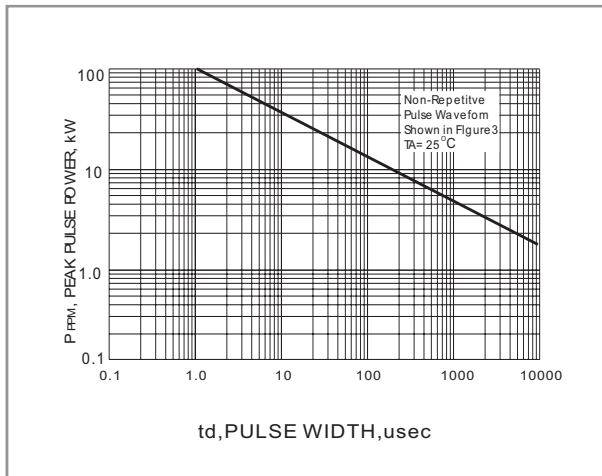

**Fig. 1 PEAK PULSE POWER RATING VERSUS PULSE TIME CURVE**

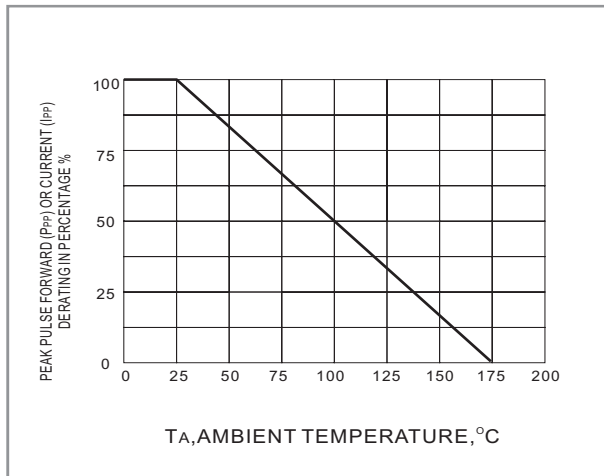

**Fig. 2 PULSE DERATING CURVE**

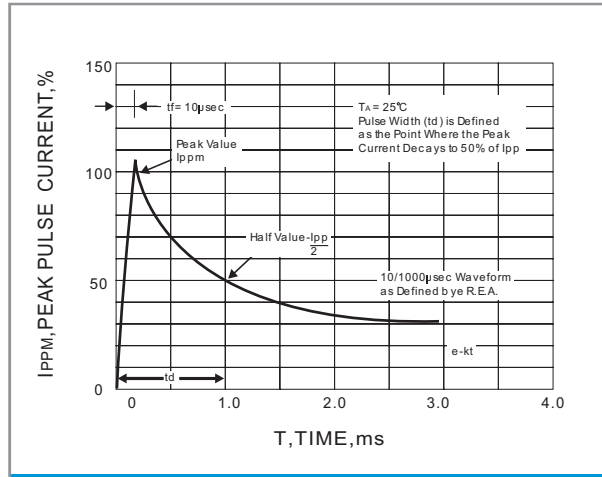

**Fig. 3 PULSE WAVEFORM**

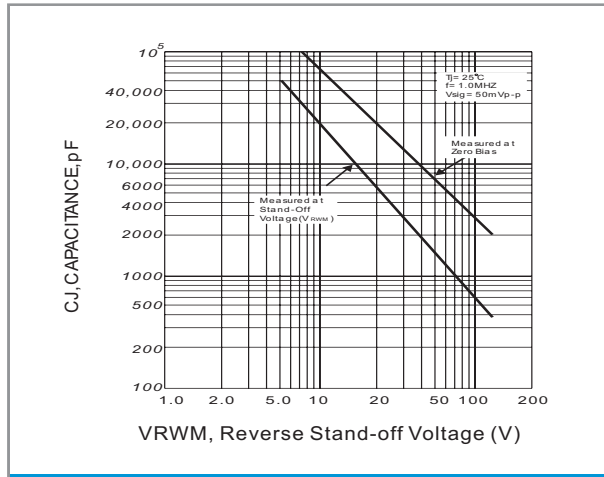

**Fig. 4 TYPICAL JUNCTION CAPACITANCE**

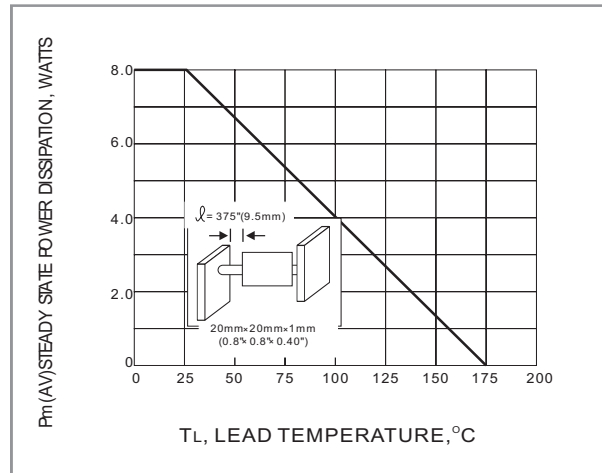

**Fig. 5 STEADY STATE POWER DERATING CURVE**

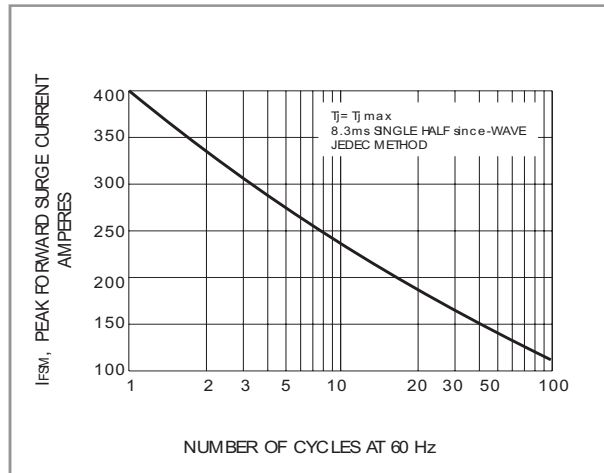

**Fig. 6 MAXIMUM NON-REPETITIVE PEAK FORWARD SURGE CURRENT UNIDIRECTIONAL**

PLEASE REFER THE TVS APPLICATION NOTE IN PANJIT WEBSITE

<http://www.panjit.com/protection-transient-voltage-suppressors.html>