

C&K 3 Series Thumbwheel Switches



Features/Benefits

- Most complete product offering in the industry
- Spacers available to fit most panel cutouts
- Front or rear mounting options

Typical Applications

- Test & measurement equipment
- Industrial equipment
- Computer devices

Specifications

CONTACT RATING:
 CARRY: 1 AMP continuous.
 SWITCH: 100 mA max.
 OPERATING VOLTAGE: 50 mV to 28 V DC or 120 V AC.
 ELECTRICAL LIFE: 100,000 actuations.
 CONTACT RESISTANCE: Below 100 m Ω typ. initial @
 2-4 V DC, 100 mA.
 INSULATION RESISTANCE: 10⁹ Ω min.
 DIELECTRIC STRENGTH: 500 Vrms min. @ sea level
 between common terminal and any output.
 OPERATING TEMPERATURE: -10°C to 65°C.

Materials

HOUSING: ABS plastic.
 THUMBWHEEL: ABS plastic.
 ROTOR CONTACTS: Precious metal on copper alloy.
 STATOR CONTACTS: Hard gold over nickel over copper
 on epoxy fiberglass.

NOTE: Specifications and materials listed above are for switches with standard options. For information on specific and custom switches, consult Customer Service Center.

* Note: All models listed are RoHS compliant. See Technical Data section of this catalog for RoHS compliant and compatible definitions and specifications.

Build-A-Switch

To order, simply select desired option from each category and place in the appropriate box. Available options are shown and described on pages N-9 thru N-12. For additional options not shown in catalog, consult Customer Service Center. Consult factory for illumination availability.

Thumbwheel & Pushwheel

Series

3 Thumbwheel switch

Number of Sections

0 Switch section
1 1 Switch section
2 2 Switch sections
3 3 Switch sections
4 4 Switch sections
5 5 Switch sections
6 6 Switch sections
7 7 Switch sections
8 8 Switch sections
9 More than 8 switch sections

Function Code

11 Decimal, SP, 10 position
14 Resistor decade
21 BCD, 10 position
23 Complement of BCD, 10 position
27 BCD, 10 position
31 BCD, 10 position
71 BCH, 16 position

Mounting Style

00 Snap-in, front mount
09 Snap-in, front mount*
10 Rear mount
19 Rear mount*
20 Rear mount
29 Rear mount*

Terminations

0 Type 0
1 Type 1, extended type 0
N Solder pins with .100" spacing**
P Solder pins with .156" spacing**
9 Any combination

Color/Marking/Stops

0 Matte black body, gloss black wheel, white marking

Seal

0 No seal
1 Sealed contacts
2 Dust lens
3 Sealed contacts & dust lens

*X9 mounting styles must be ordered with '0' number of sections.

** Note: Termination option N (RoHS compliant) replaced termination option 3 (Non-RoHS compliant). Termination option P (RoHS compliant) replaced termination option B (Non-RoHS compliant).

C&K 3 Series Thumbwheel Switches

SERIES

3 THUMBWHEEL SWITCHES

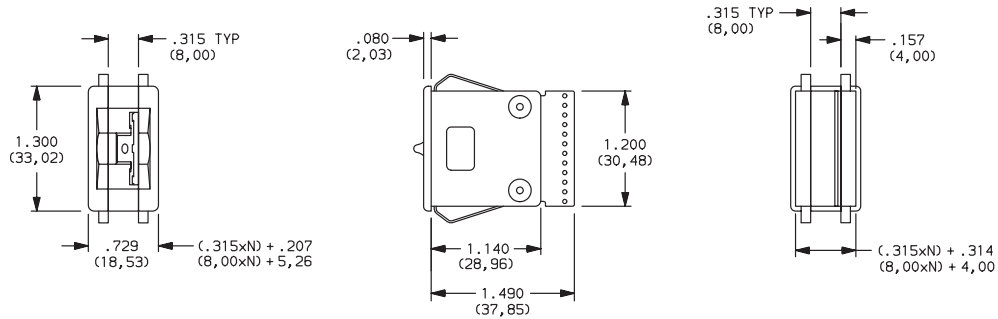

NUMBER OF SECTIONS

- 0** Switch section only, no assembly. Blank bodies are considered sections; endplates are not sections. Must be ordered with 09 or 19 mounting style options, see pages N-10 and N-11.
- 1-8** Number of switch sections in assembly, includes endplates.
- 9** More than 8 switch sections, specify on CONFIGURATION FORM, page N-15 and consult Customer Service Center.

NOTE: Endplates and blank sections available separately, see pages N-13 and N-14.

FUNCTION CODE

- 11** DECIMAL-1 POLE; 10 POSITION
- 14** RESISTOR DECADE; 1-2-2-2-2 CODE (RESISTORS NOT SUPPLIED)
- 21** BCD 1-2-4-8; 10 POSITION

W H E E L	SIGNALS CONNECTED TO COMMON SIGNAL C										C
	0	1	2	3	4	5	6	7	8	9	
0	●										●
1		●									●
2			●								●
3				●							●
4					●						●
5						●					●
6							●				●
7								●			●
8									●		●
9										●	●
	2	3	4	5	6	7	8	9	10	11	12
	TERM. LOCATION										

Available Terminations: 0, 1, N
See fig. 1, page N-12.

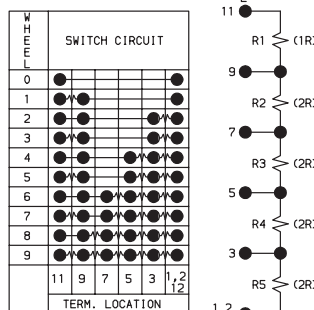

Available Terminations: 1
See fig. 1, page N-12.

W H E E L	SIGNALS CONN. TO COMM. SIG. C				C
	1	2	4	8	
0					●
1	●				●
2		●			●
3			●		●
4				●	●
5	●				●
6	●	●			●
7	●	●	●		●
8	●	●	●	●	●
9	●				●
	3	5	7	11	9
	TERM. LOCATION				

Available Terminations: 0, 1, N
See fig. 1, page N-12.

NOTE: For terminal location diagram, see page N-12.

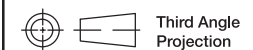

Dimensions are shown: Inch (mm)
Specifications and dimensions subject to change



C&K 3 Series Thumbwheel Switches

FUNCTION CODE

23 COMPLEMENT OF BCD 1-2-4-8;
10 POSITION

W H E E L	SIGNALS CONN. TO COMM. SIG. C			
	1	2	4	8
0	●	●	●	●
1	●	●	●	●
2	●	●	●	●
3	●	●	●	●
4	●	●	●	●
5	●	●	●	●
6	●	●	●	●
7	●	●	●	●
8	●	●	●	●
9	●	●	●	●
	3	9	11	5
	TERM. LOCATION			

Available Terminations: 0, 1, N
See fig. 1, page N-12.

27 BCD 1-2-4-8; 10 POSITION

W H E E L	SIGNALS CONN. TO COMM. SIG. C			
	1	2	4	8
0	●			●
1	●			●
2	●	●		●
3	●	●		●
4	●	●	●	●
5	●	●	●	●
6	●	●	●	●
7	●	●	●	●
8	●	●	●	●
9	●	●	●	●
	4	5	1	2
	TERM. LOCATION			

Available Terminations: P
See fig. 2, page N-12.

31 BCD 1-2-4-8; 10 POSITION

W H E E L	SIGNALS CONN. TO COMM. SIG. C			
	1	2	4	8
0	●			●
1	●			●
2	●	●		●
3	●	●		●
4	●	●	●	●
5	●	●	●	●
6	●	●	●	●
7	●	●	●	●
8	●	●	●	●
9	●	●	●	●
	2	3	11	9
	TERM. LOCATION			

Available Terminations: 0, 1, N
See fig. 1, page N-12.

71 BINARY CODED HEXADECIMAL,
16 POSITION

W H E E L	SIGNALS CONN. TO COMM. SIG. C			
	1	2	4	8
0	●			●
1	●			●
2	●	●		●
3	●	●		●
4	●	●	●	●
5	●	●	●	●
6	●	●	●	●
7	●	●	●	●
8	●	●	●	●
9	●	●	●	●
A	●	●	●	●
B	●	●	●	●
C	●	●	●	●
D	●	●	●	●
E	●	●	●	●
F	●	●	●	●
	3	5	7	11
	TERM. LOCATION			

Available Terminations: 0, 1, N
See fig. 1, page N-12.

NOTE: For terminal location diagram, see page N-12.

MOUNTING STYLE

Type 0 Snap-In Front Mount

Thumbwheel & Pushwheel

MOUNTING STYLE	DIM. 'A'
00	$(.315 \times N) + .326$ $(8.00 \times N) + (8.28)$

N = Number of sections.

Recommended panel thickness:
0.46-.125
(1.16-3.18)

PANEL MOUNTING

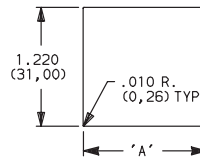

00 SWITCH ASSEMBLY W/ ENDPLATES--.315 (8,00) SECTION PITCH

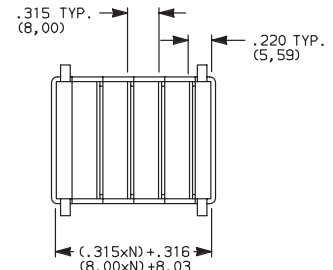
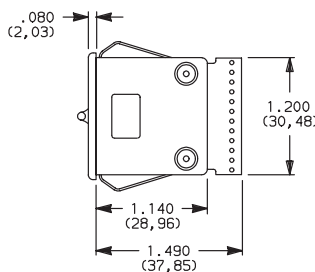
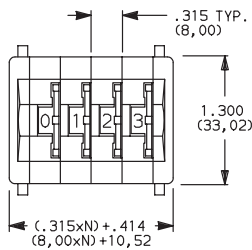

N = Number of sections.

09 SWITCH SECTION ONLY--UNASSEMBLED WITHOUT ENDPLATES OR SPACERS
(Must be ordered with number of sections option "0", see Page N-9.)

NOTE: Endplates, blank sections, spacers
and assembly hardware available separately, see pages N-13 and N-14.

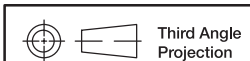

Third Angle
Projection

Dimensions are shown: Inch (mm)
Specifications and dimensions subject to change



C&K 3 Series Thumbwheel Switches

MOUNTING STYLE

Type 1 Rear Mount

MOUNTING STYLE	DIM. 'A'	DIM. 'B'
10	$(.350 \times N) + .340$ $(8,89 \times N) + (8,64)$	$(.350 \times N) + .560$ $(8,89 \times N) + (14,22)$

N = Number of sections.

Recommended panel thickness:
0.46-.125
(1,16-3,18)

PANEL MOUNTING

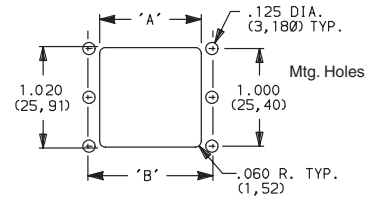

10 SWITCH ASSEMBLY W/ ENDPLATES--.350 (8,89) SECTION PITCH

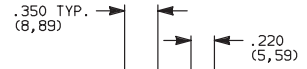
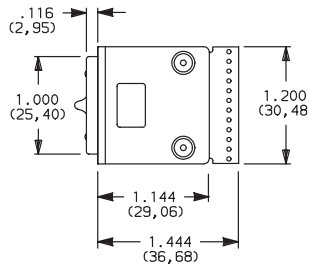
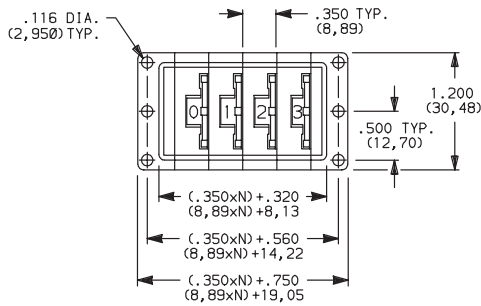

N = Number of sections.

19 SWITCH SECTION ONLY--UNASSEMBLED WITHOUT ENDPLATES OR SPACERS (Must be ordered with number of sections option "0", see Page N-9.)

Type 2 Rear Mount

20 SWITCH ASSEMBLY W/ ENDPLATES--.350 (8,89) SECTION PITCH

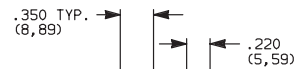
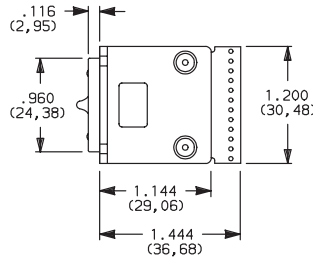
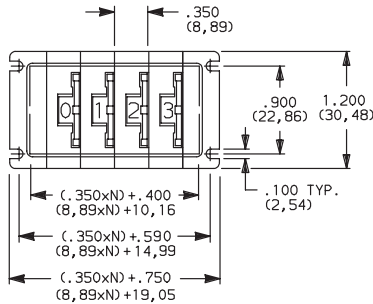

N = Number of sections.

29 SWITCH SECTION ONLY--UNASSEMBLED WITHOUT ENDPLATES OR SPACERS (Must be ordered with number of sections option "0", see Page N-9.)

Thumbwheel & Pushwheel



N

NOTE: Endplates, blank sections, spacers and assembly hardware available separately, see pages N-13 and N-14.

C&K 3 Series Thumbwheel Switches

TERMINATIONS

0 TYPE 0

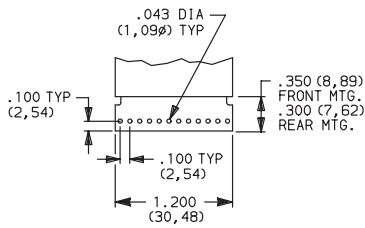

1 TYPE 1, EXTENDED TYPE 0

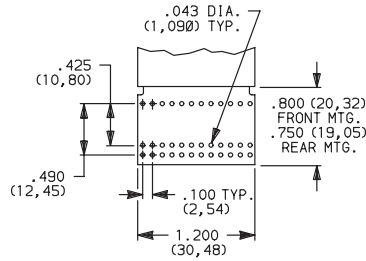

Signal traces cut except for common(s).

N SOLDER PINS WITH .100" SPACING

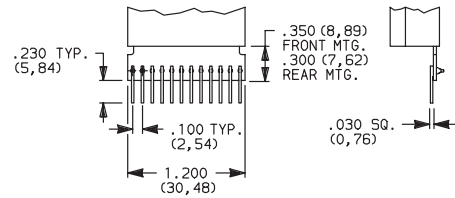

9 ANY COMBINATION OF TERMINATION CONFIGURATIONS OR SPECIAL TERMINATIONS.

Specify on configuration form, page N-15 and consult Customer Service Center.

P SOLDER PINS WITH .156" SPACING

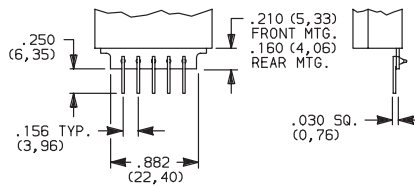

PC Board 1/32" (0,79) thick.

NOTE: All terminal holes shown may not be present for all function codes, consult Customer Service Center. Terminal connector available for termination options 0 & 1, see page N-14.

NOTE: Termination option N (RoHS compliant) replaced termination option 3 (Non-RoHS compliant). Termination option P (RoHS compliant) replaced termination option B (Non-RoHS compliant).

Terminal Location Numbers

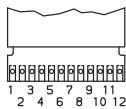

FIG. 1

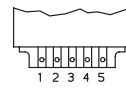
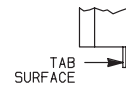

FIG. 2



NOTE: See function codes, pages N-9 and N-10, for signal locations.

COLOR/MARKING/STOPS

0 MATTE BLACK HOUSING (Gloss black wheel with white characters; no stops.)

NOTE: Stop pins are available separately, see page N-14.

SEAL

0 UNSEALED SWITCHING CONTACTS.

1 SEALED SWITCHING CONTACTS. (Sealing is by means of an o-ring rotary seal and a cured-in-place elastomer gasket. Switching contact area is protected from moisture, oil, and airborne contaminants.)

2 DUST LENS. (Protects the character face of the wheel from abrasion and dirt.)

3 SEALED SWITCHING CONTACTS AND DUST LENS

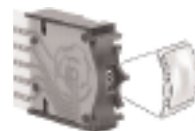

Dust Lens



Third Angle Projection

Dimensions are shown: Inch (mm)
Specifications and dimensions subject to change



C&K 3 Series Thumbwheel Switches

AVAILABLE HARDWARE

Blank sections, Type 0,
.315 THK.



PART NO.
413602000 W/RIB-BLACK
400502000 W/RIB & W/OUT SPRINGS-BLACK

Blank sections, Front mount, Type 0,
.315 THK.



PART NO.
413502000 PLAIN-BLACK
400702000 PLAIN & W/OUT SPRINGS-BLACK

Blank sections, Rear mount, Type 1,
.350 THK.



4006 4008

PART NO.
400602000 W/RIB-BLACK
400802000 PLAIN-BLACK

Blank sections, Rear mount, Type 2,
.350 THK.



4734 4733

PART NO.
473402000 W/RIB-BLACK
473302000 PLAIN-BLACK

End plates, Front mount, Type 0



PART NO.
413402000 BLACK
Two required for complete assembly.

End plates, Rear mount, Type 1



PART NO.
400402000 BLACK
Two required for complete assembly.

End plates, Rear mount, Type 2



PART NO.
473202000 BLACK
Two required for complete assembly.

Spacers, Front mount, Type 0 & 3, .078 THK.
(Makes section pitch 10mm)



PART NO.
410802000 BLACK

Stop pins



PART NO.
402900000

Thumbwheel & Pushwheel



N

C&K 3 Series Thumbwheel Switches

AVAILABLE HARDWARE

Terminal connector

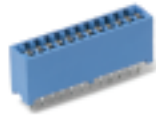

605A00000

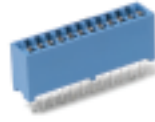

605A02000

PART NO.

605A00000 PC

605A02000 SOLDER LUG

Fits 0 & 1 terminations only.

Screws for field assembly of thumbwheel switches
(2 screws needed per assembly + 403500000 nuts)

SCREW PART NUMBER (0-80 UNF THD. SIZE)	NUMBER OF SECTIONS IN ASSEMBLY	
	FRONT MOUNTING	REAR MOUNTING
	MTG. STYLE - 00	MTG. STYLE - 10
412700000	1-2	1-2
412701000	3-4	3
412702000	5-7	4-6

Thumbwheel & Pushwheel

Nut



Two nuts required per assembly and screws.

PART NO.

403500000

Nut driver (For 403500000 nut)



PART NO.

406100652



C&K 3 Series Thumbwheel Switches

Configuration Form

GRAY SHADED AREAS TO BE FILLED IN BY CUSTOMER SERVICE.

CATALOG PART NO.

3

C&K PART NUMBER

C&K PART NUMBER

COMPANY NAME _____











CUSTOMER PRINT REVISION:

ADDRESS _____ TEL.# _____

CUSTOMER CONTACT _____ DATE _____

DETAILS:

ORIGINATED BY _____ SALES REP. _____

THUMBWHEEL SECTIONS	NO. OF SEC.	FUNCTION CODE – TERMINATIONS – COLOR/MARKING/STOPS/SEAL – ILLUMINATION <small>ENTER OPTION CODES IN APPROPRIATE BOXES. FUNCTION CODES INCLUDE BLANK SECTIONS (SEE PAGES M-9 & M-10).</small>	DESCRIBE IN APPROPRIATE ROW
	1	3 - <input type="text"/> <input type="text"/> - - <input type="text"/> <input type="text"/> <input type="text"/> <input type="text"/>	
	2	3 - <input type="text"/> <input type="text"/> - - <input type="text"/> <input type="text"/> <input type="text"/> <input type="text"/>	
	3	3 - <input type="text"/> <input type="text"/> - - <input type="text"/> <input type="text"/> <input type="text"/> <input type="text"/>	
	4	3 - <input type="text"/> <input type="text"/> - - <input type="text"/> <input type="text"/> <input type="text"/> <input type="text"/>	
	5	3 - <input type="text"/> <input type="text"/> - - <input type="text"/> <input type="text"/> <input type="text"/> <input type="text"/>	
	6	3 - <input type="text"/> <input type="text"/> - - <input type="text"/> <input type="text"/> <input type="text"/> <input type="text"/>	
	7	3 - <input type="text"/> <input type="text"/> - - <input type="text"/> <input type="text"/> <input type="text"/> <input type="text"/>	
	8	3 - <input type="text"/> <input type="text"/> - - <input type="text"/> <input type="text"/> <input type="text"/> <input type="text"/>	
	9	3 - <input type="text"/> <input type="text"/> - - <input type="text"/> <input type="text"/> <input type="text"/> <input type="text"/>	
	10	3 - <input type="text"/> <input type="text"/> - - <input type="text"/> <input type="text"/> <input type="text"/> <input type="text"/>	
	11	3 - <input type="text"/> <input type="text"/> - - <input type="text"/> <input type="text"/> <input type="text"/> <input type="text"/>	

QUALITY CONTROL INSTRUCTIONS

PRODUCTION APPROVAL DATE

Q.C. APPROVAL DATE

REV. INITIALS DATE

FOR SWITCHES WITH MORE THAN 11 SECTIONS, CONTINUE ON ADDITIONAL SHEETS.

SPECIAL INSTRUCTIONS OR SPECIFICATIONS:

SHEET ____ OF ____



Dimensions are shown: Inch (mm)
Specifications and dimensions subject to change

Thumbwheel & Pushwheel

