

SWITCHING REGURATOR APPLICATIONS

**Features**

- High Voltage:  $BV_{DSS}=80V(\text{Min.})$
- Low  $C_{rSS}$  :  $C_{rSS}=220pF(\text{Typ.})$
- Low gate charge :  $Qg=80nC(\text{Typ.})$
- Low  $R_{DS(on)}$  :  $R_{DS(on)}=17m\Omega(\text{Max.})$

**Ordering Information**

Type NO.	Marking	Package Code
STK7508P	STK7508	TO-220AB-3L

**Outline Dimensions**

unit : mm

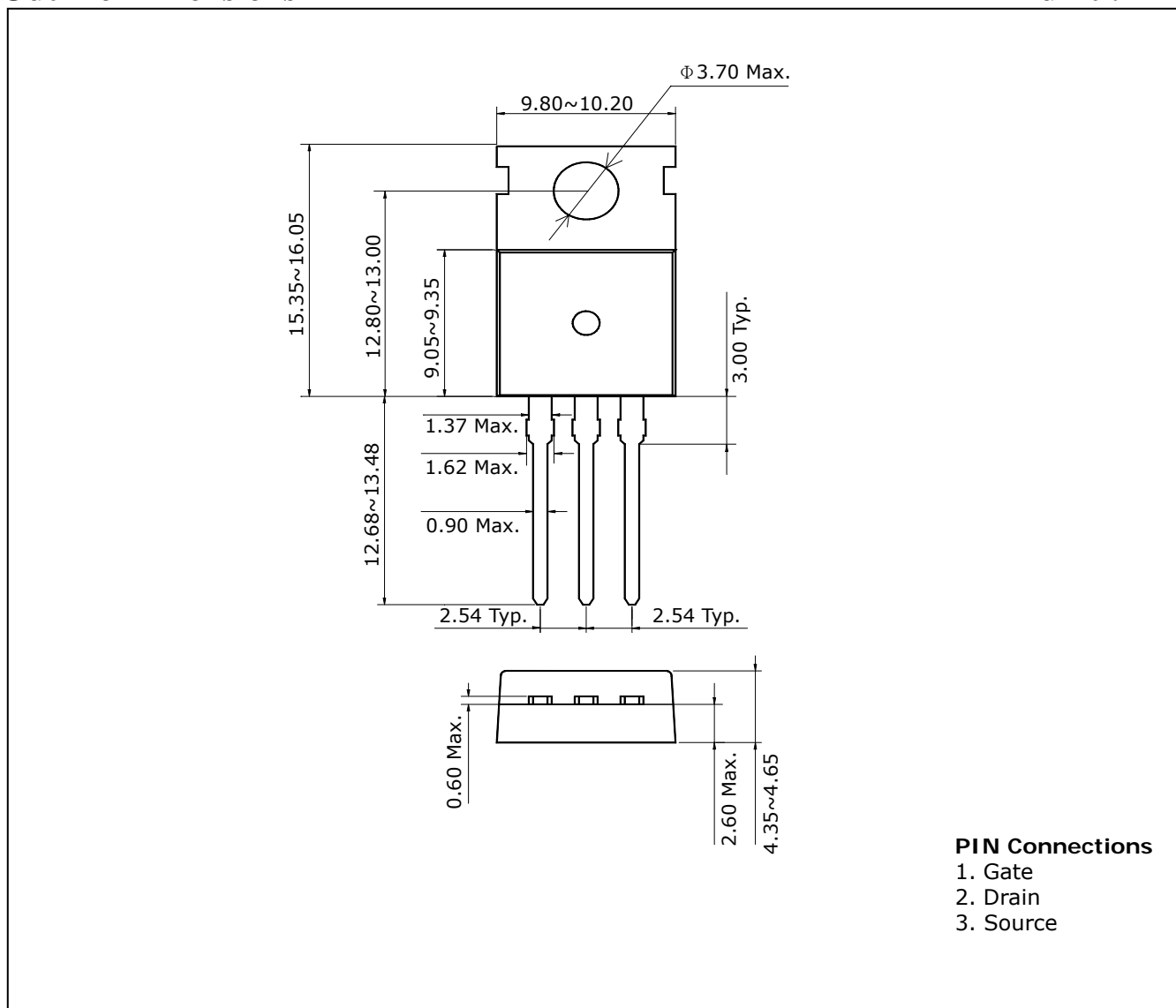

**PIN Connections**

1. Gate
2. Drain
3. Source

## Absolute maximum ratings (Tc=25°C)

Characteristic	Symbol	Rating	Unit
Drain-Source voltage	$V_{DSS}$	80	V
Gate-Source voltage	$V_{GSS}$	±20	V
Continuous Drain current (Tc=25°C)	$I_D$	75	A
Continuous Drain current (Tc=100°C)	$I_D$	54.3	A
Drain Current-Pulsed ①	$I_{DM}$	300	A
Power Dissipation (Tc=25°C)	$P_D$	220	W
Single Pulsed Avalanche Energy ②	$E_{AS}$	1310	mJ
Avalanche current ①	$I_{AR}$	75	A
Repetitive Avalanche Energy ①	$E_{AR}$	17.3	mJ
Junction temperature	$T_J$	175	°C
Storage temperature range	$T_{stg}$	-55~175	

## Thermal Resistance

Characteristic	Symbol	Typ.	Max	Units
Junction to Case	$R_{th(J-C)}$	-	0.68	°C/W
Junction to Ambient	$R_{th(J-a)}$	-	62.5	

## Electrical Characteristics (Tc=25°C)

Characteristic	Symbol	Test Condition	Min.	Typ.	Max.	Unit	
Drain-Source breakdown voltage	$BV_{DSS}$	$I_D=250\mu A, V_{GS}=0$	80	-	-	V	
Gate-Threshold voltage	$V_{GS(th)}$	$I_D=250\mu A, V_{DS}=V_{GS}$	2.0	-	4.0	V	
Drain-source leakage current	$I_{DSS}$	$V_{DS}=80V, V_{GS}=0V$	-	-	10	$\mu A$	
Gate-source leakage	$I_{GSS}$	$V_{DS}=0V, V_{GS}=\pm 20V$	-	-	$\pm 100$	nA	
Drain-Source on-resistance ③	$R_{DS(on)}$	$V_{GS}=10V, I_D=37.5A$	-	14	17	m $\Omega$	
Forward transfer admittance ③	$g_{fs}$	$V_{DS}=20V, I_D=37.5A$	-	15	-	S	
Input capacitance	$C_{iss}$	$V_{GS}=0V, V_{DS}=25V, f=1MHz$	-	2540	3210	pF	
Output capacitance	$C_{oss}$		-	950	1200		
Reverse transfer capacitance	$C_{rss}$		-	220	275		
Turn-on delay time	$t_{d(on)}$	$V_{DD}=40V, I_D=75A$ $R_G=25\Omega$	-	40	80	ns	
Rise time	$t_r$		-	230	460		
Turn-off delay time	$t_{d(off)}$		③④	-	170		340
Fall time	$t_f$		-	190	330		
Total gate charge	$Q_g$	$V_{DS}=60V, V_{GS}=10V,$ $I_D=75A$	-	80	105	nC	
Gate-source charge	$Q_{gs}$		③④	-	16		-
Gate-drain("Miller")charge	$Q_{gd}$		-	30	-		

## Source-Drain Diode Ratings and Characteristics (Tc=25°C)

Characteristic	Symbol	Test Condition	Min	Typ	Max	Units
Continuous source current	$I_S$	Integral reverse diode in the MOSFET	-	-	75	A
Pulsed-source current ①	$I_{SM}$		-	-	300	
Diode forward voltage ④	$V_{SD}$	$V_{GS}=0V, I_S=75A$	-	-	1.5	V
Reverse recovery time	$t_{rr}$	$I_S=75A$ $di_F/dt=100A/us$	-	90	-	ns
Reverse recovery charge	$Q_{rr}$		③	-	250	-

Note ;

- ① Repetitive Rating : Pulse Width Limited by Maximum Junction Temperature
- ②  $L=0.32mH, I_{AS}=75A, V_{DD}=25V, R_G=25\Omega$ , starting  $T_J=25^\circ C$
- ③ Pulse Test : Pulse Width < 300us, Duty cycle  $\leq 2\%$
- ④ Essentially independent of operating temperature

## Electrical Characteristic Curves

**Fig. 1  $I_D - V_{DS}$**

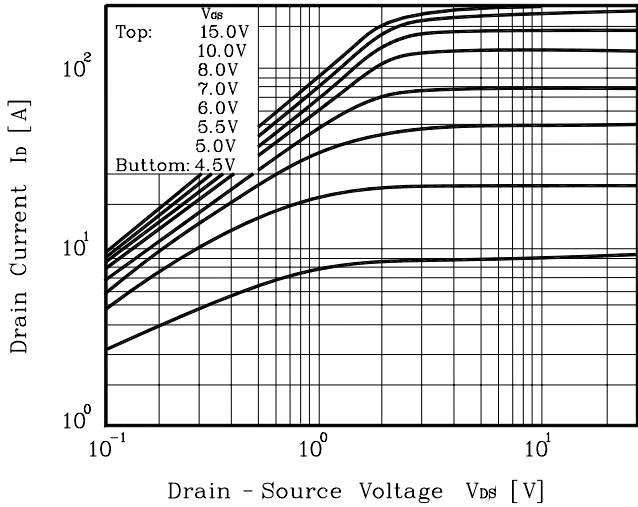

**Fig. 2  $I_D - V_{GS}$**

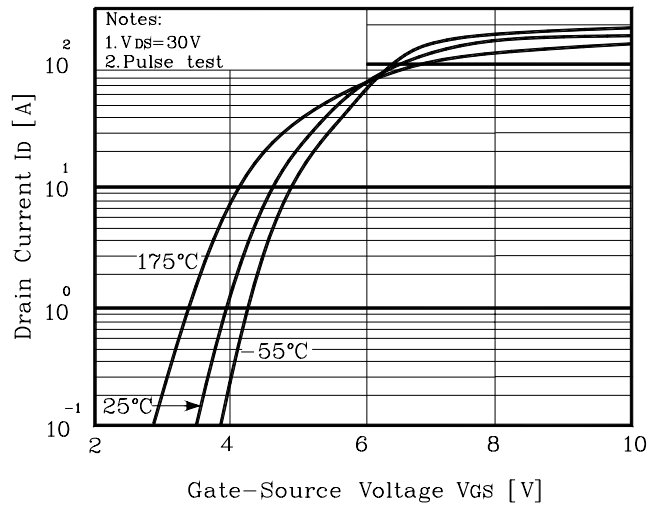

**Fig. 3  $R_{DS(on)} - I_D$**

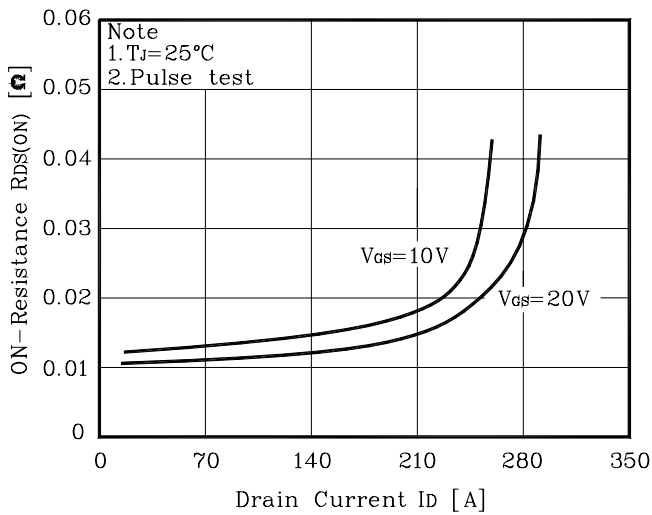

**Fig. 4  $I_S - V_{SD}$**

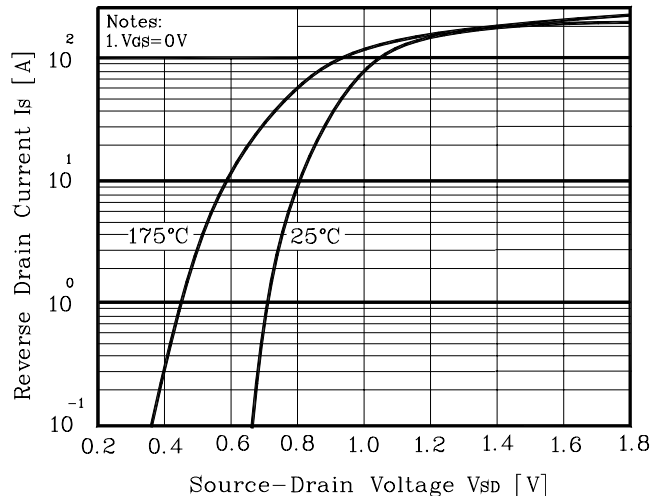

**Fig. 5 Capacitance -  $V_{DS}$**

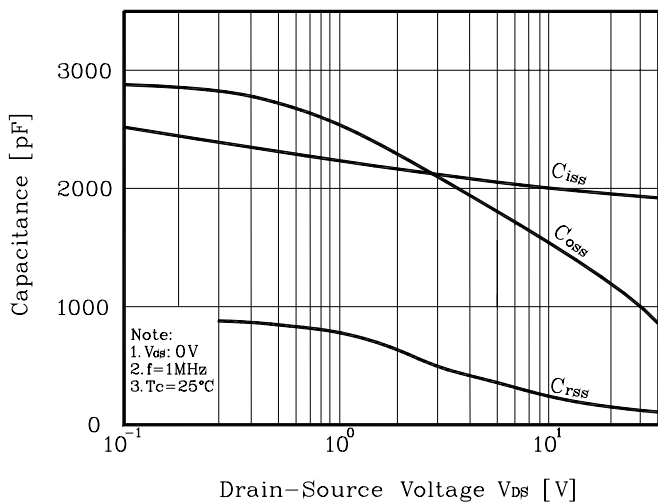

**Fig. 6  $V_{GS} - Q_G$**

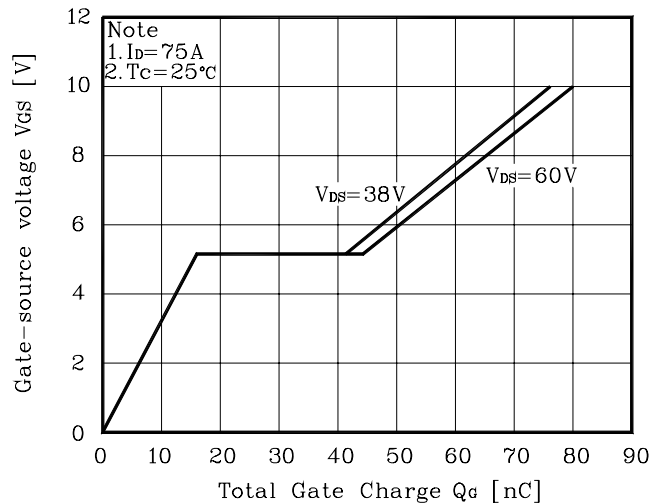

**Fig. 7  $V_{DSS} - T_J$**

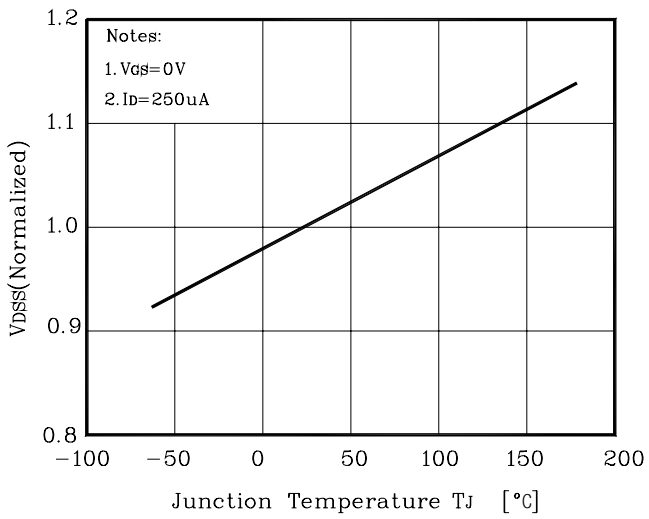

**Fig.8  $R_{DS(on)} - T_J$**

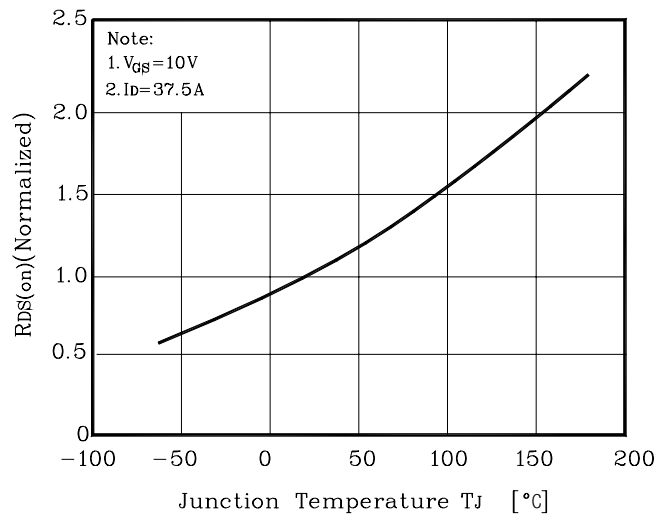

**Fig. 9  $I_D - T_C$**

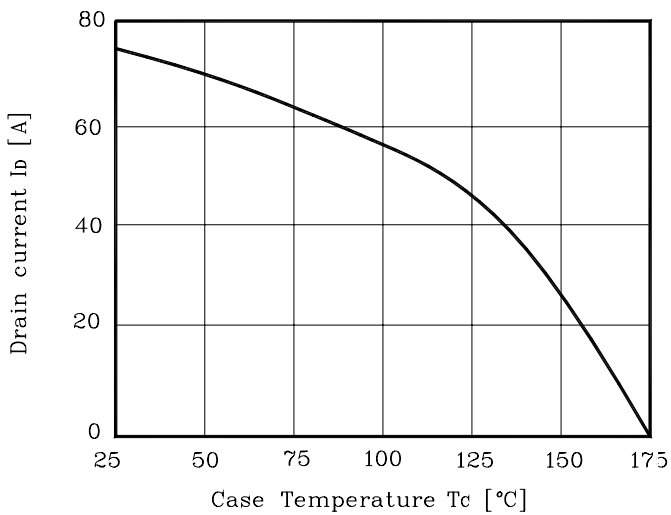

**Fig. 10 Safe Operating Area**

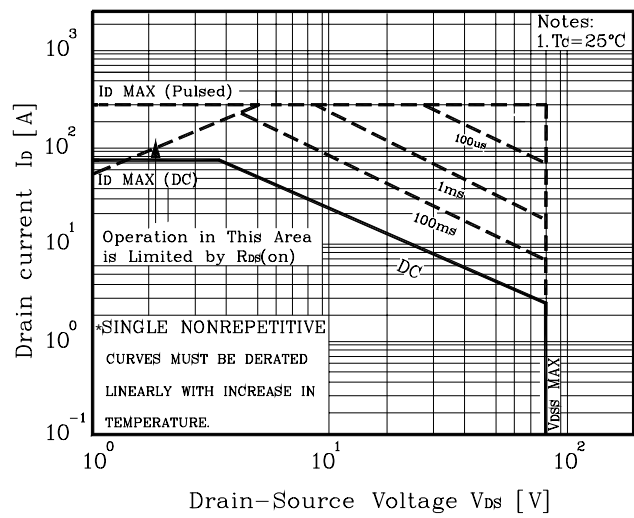

**Fig. 10 Gate Charge Test Circuit & Waveform**

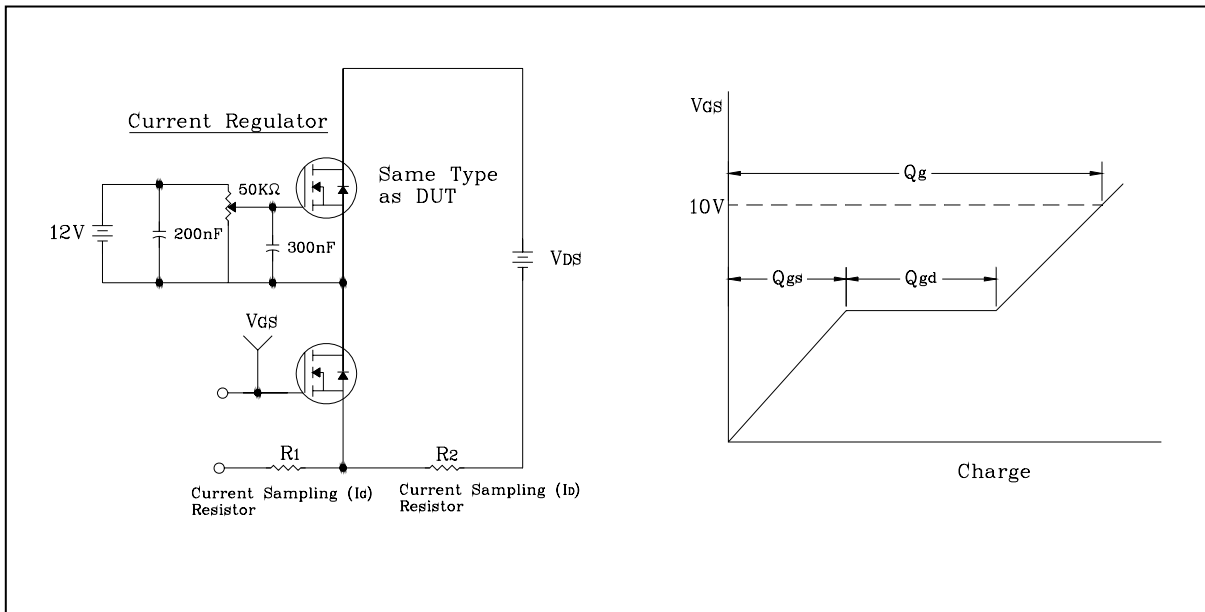

**Fig. 11 Resistive Switching Test Circuit & Waveform**

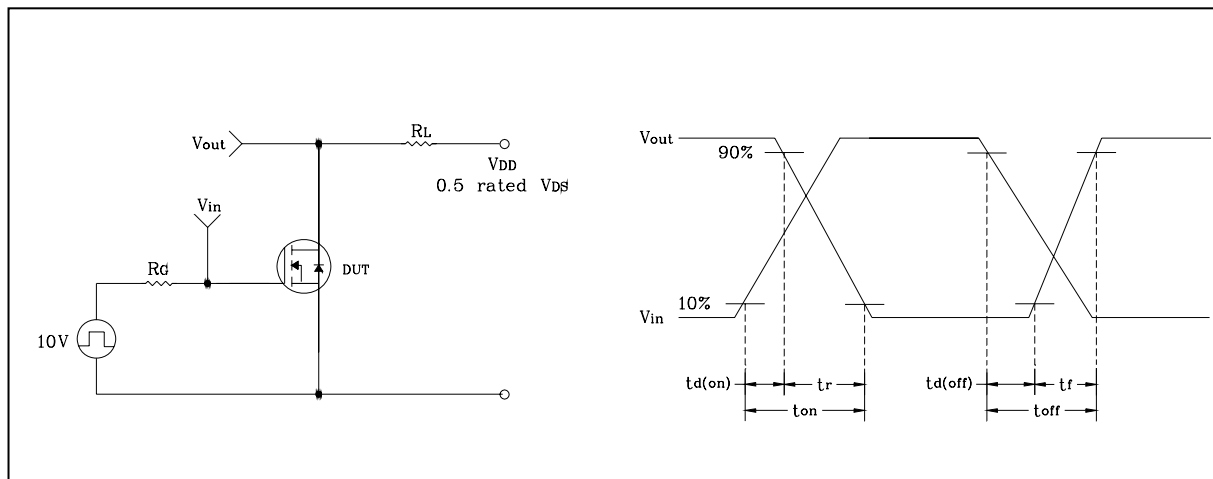

**Fig. 12 EAS Test Circuit & Waveform**

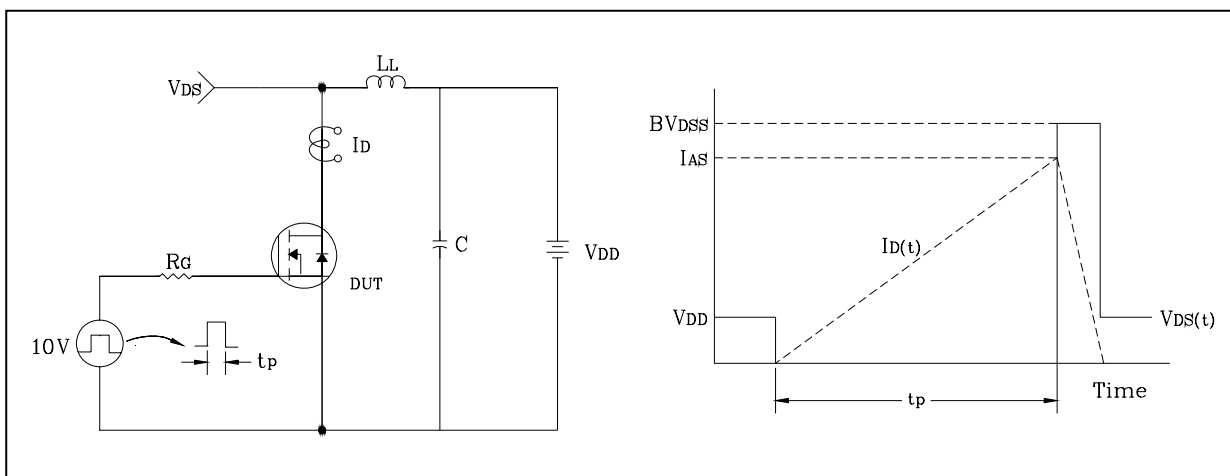
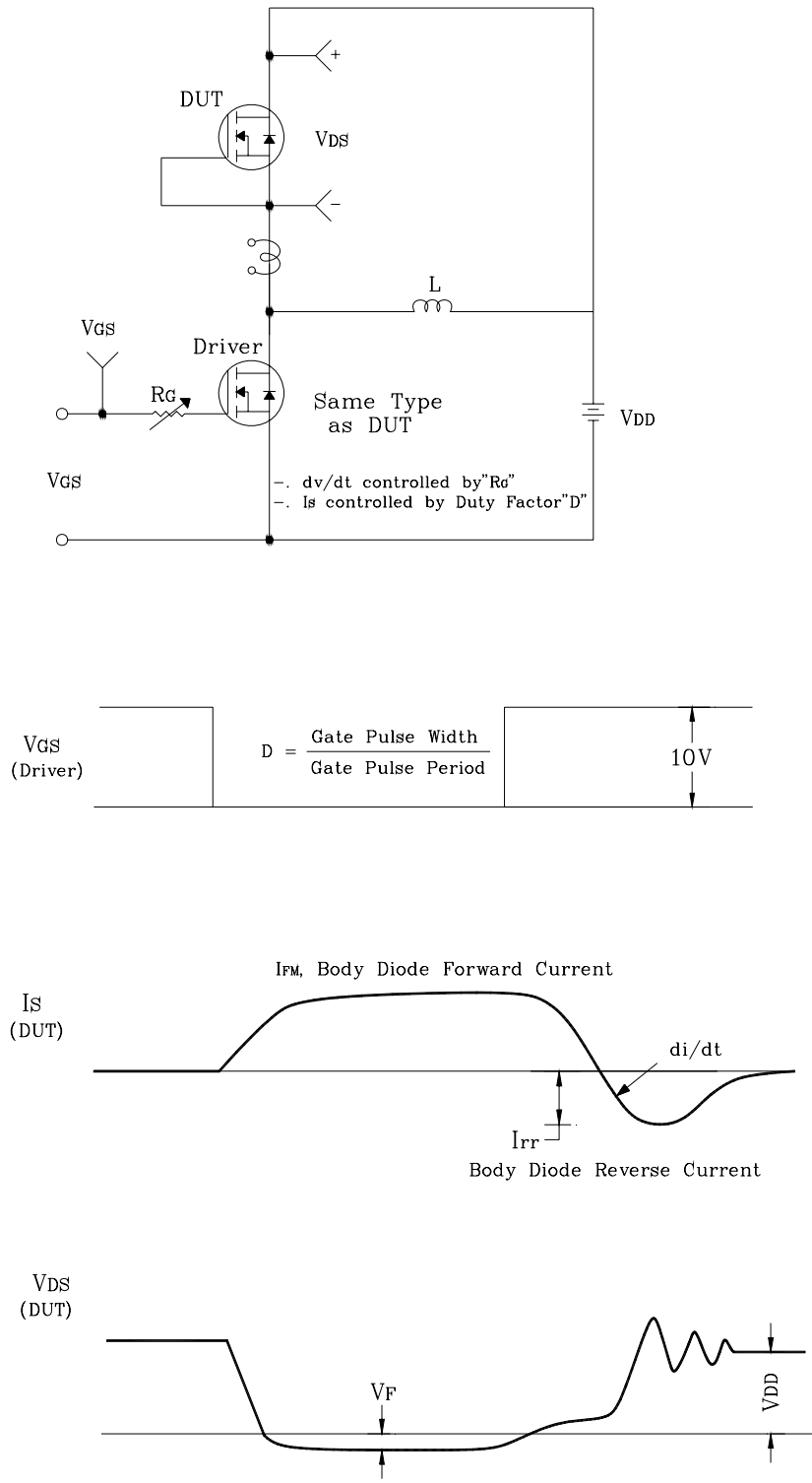

Fig. 13 Diode Reverse Recovery Time Test Circuit & Waveform



**The AUK Corp. products are intended for the use as components in general electronic equipment (Office and communication equipment, measuring equipment, home appliance, etc.).**

**Please make sure that you consult with us before you use these AUK Corp. products in equipments which require high quality and / or reliability, and in equipments which could have major impact to the welfare of human life(atomic energy control, airplane, spaceship, transportation, combustion control, all types of safety device, etc.). AUK Corp. cannot accept liability to any damage which may occur in case these AUK Corp. products were used in the mentioned equipments without prior consultation with AUK Corp..**

**Specifications mentioned in this publication are subject to change without notice.**