

SKM 75GB128DN



SEMITRANS™ 2N

SPT IGBT Module

SKM 75GB128DN

Preliminary Data

Features

- Homogeneous Si
- SPT = Soft-Punch-Through technology
- $V_{CE(sat)}$ with positive temperature coefficient
- High short circuit capability, self limiting to $6 \times I_C$

Typical Applications

- AC inverter drives
- UPS
- Electronic welders at $f_{sw} > 20$ kHz

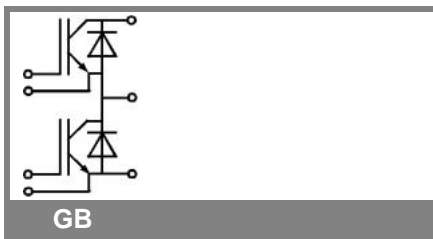

Absolute Maximum Ratings		$T_c = 25^\circ\text{C}$, unless otherwise specified	
Symbol	Conditions	Values	Units
IGBT			
V_{CES}		1200	V
I_C	$T_c = 25$ (80) $^\circ\text{C}$	100 (70)	A
I_{CRM}	$t_p = 1$ ms	100	A
V_{GES}		± 20	V
T_{vj} (T_{stg})	$T_{OPERATION} \leq T_{stg}$	- 40...+ 150 (125)	$^\circ\text{C}$
V_{isol}	AC, 1 min.	4000	V
Inverse diode			
I_F	$T_c = 25$ (80) $^\circ\text{C}$	75 (50)	A
I_{FRM}	$t_p = 1$ ms	100	A
I_{FSM}	$t_p = 10$ ms; sin.; $T_j = 150^\circ\text{C}$	550	A

Characteristics		$T_c = 25^\circ\text{C}$, unless otherwise specified			
Symbol	Conditions	min.	typ.	max.	Units
IGBT					
$V_{GE(th)}$	$V_{GE} = V_{CE}$, $I_C = 2$ mA	4,5	5,5	6,5	V
I_{CES}	$V_{GE} = 0$, $V_{CE} = V_{CES}$, $T_j = 25$ (125) $^\circ\text{C}$		0,1	0,3	mA
$V_{CE(TO)}$	$T_j = 25$ (125) $^\circ\text{C}$		1 (0,9)	1,15 (1,05)	V
r_{CE}	$V_{GE} = 15$ V, $T_j = 25$ (125) $^\circ\text{C}$		18 (24)	24 (30)	m Ω
$V_{CE(sat)}$	$I_C = 50$ A, $V_{GE} = 15$ V, chip level		1,9 (2,1)	2,35 (2,55)	V
C_{ies}	under following conditions		4,5		nF
C_{oes}	$V_{GE} = 0$, $V_{CE} = 25$ V, $f = 1$ MHz		0,6		nF
C_{res}			0,55		nF
L_{CE}				25	nH
$R_{CC'+EE'}$	res., terminal-chip $T_c = 25$ (125) $^\circ\text{C}$		0,75 (1)		m Ω
$t_{d(on)}$	$V_{CC} = 600$ V, $I_C = 50$ A		90		ns
t_r	$R_{Gon} = R_{Goff} = 15$ Ω , $T_j = 125^\circ\text{C}$		55		ns
$t_{d(off)}$	$V_{GE} \pm 15$ V		440		ns
t_f			40		ns
$E_{on} (E_{off})$			5,7 (4,7)		mJ
Inverse diode					
$V_F = V_{EC}$	$I_F = 50$ A; $V_{GE} = 0$ V; $T_j = 25$ (125) $^\circ\text{C}$		2 (1,8)	2,5	V
$V_{(TO)}$	$T_j = 25$ (125) $^\circ\text{C}$		1,1	1,2	V
r_T	$T_j = 25$ (125) $^\circ\text{C}$		18	26	m Ω
I_{RRM}	$I_F = 50$ A; $T_j = 125$ () $^\circ\text{C}$		80		A
Q_{rr}	$di/dt = 2100$ A/ μs		8,5		μC
E_{rr}	$V_{GE} = 0$ V		3,1		mJ
Thermal characteristics					
$R_{th(j-c)}$	per IGBT			0,3	K/W
$R_{th(j-c)D}$	per Inverse Diode			0,6	K/W
$R_{th(c-s)}$	per module			0,05	K/W
Mechanical data					
M_s	to heatsink M6	3		5	Nm
M_t	to terminals M5	2,5		5	Nm
w				160	g

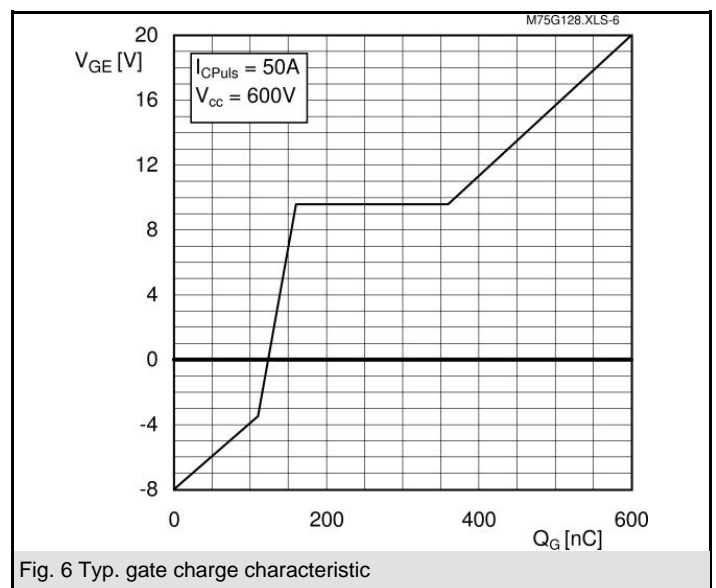
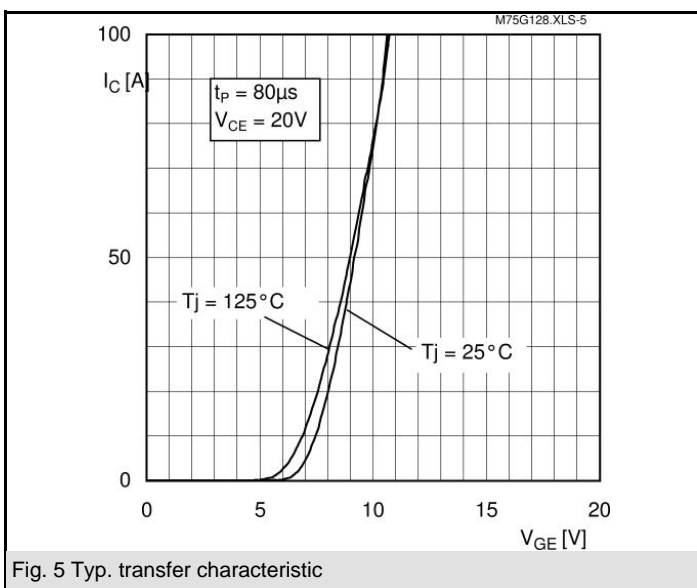
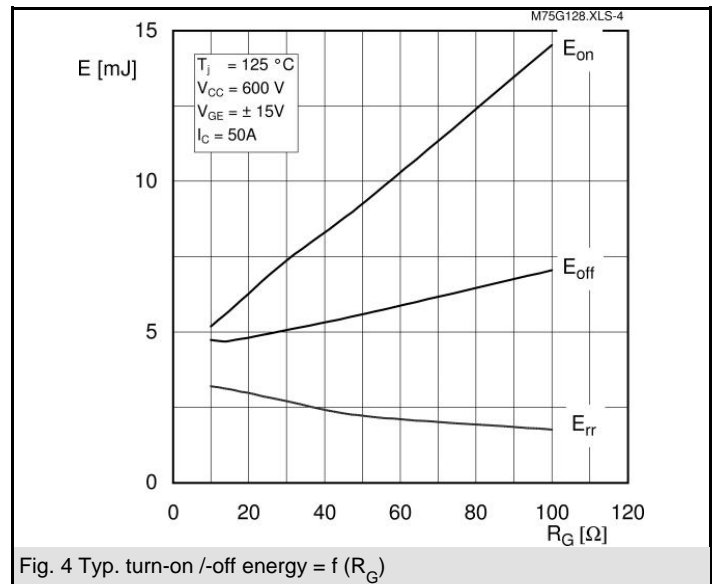
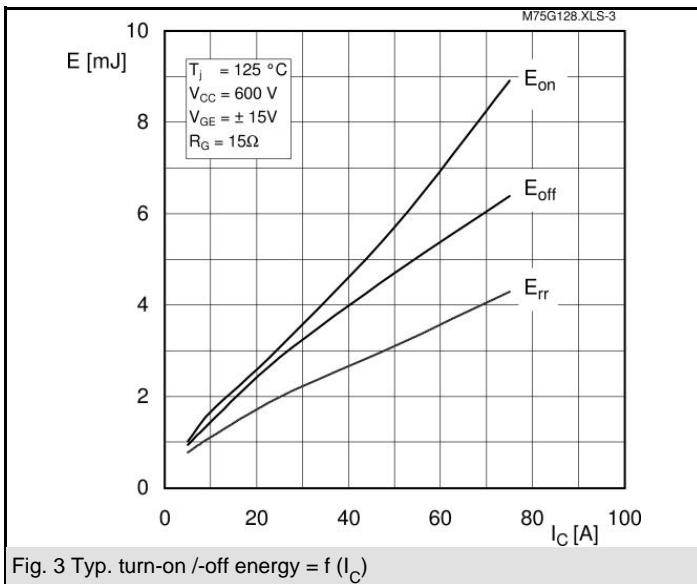
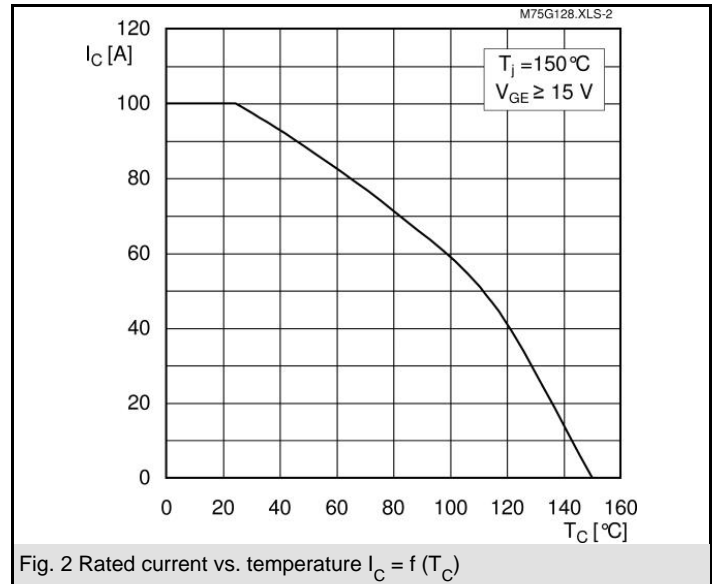
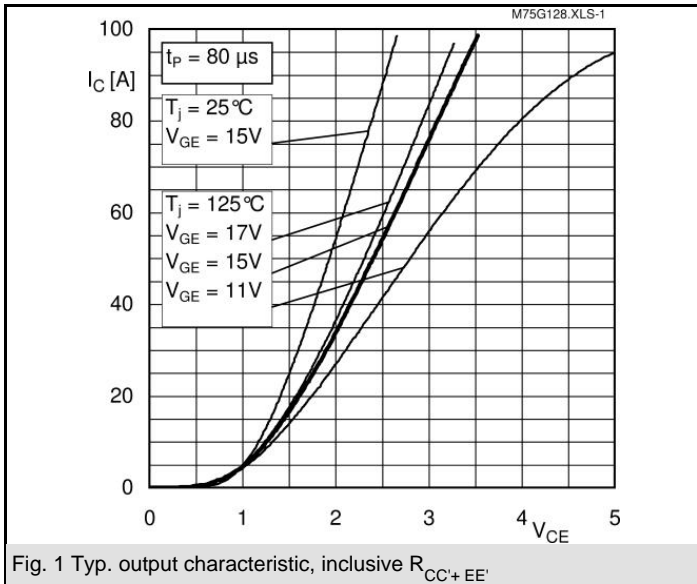

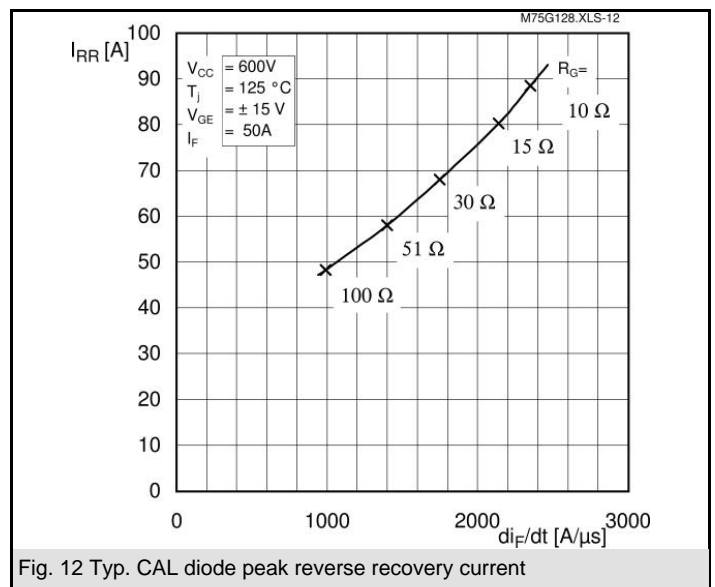
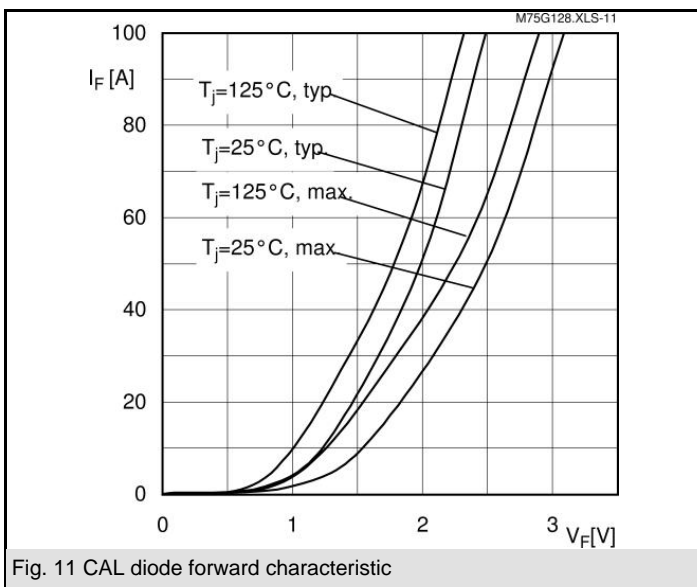
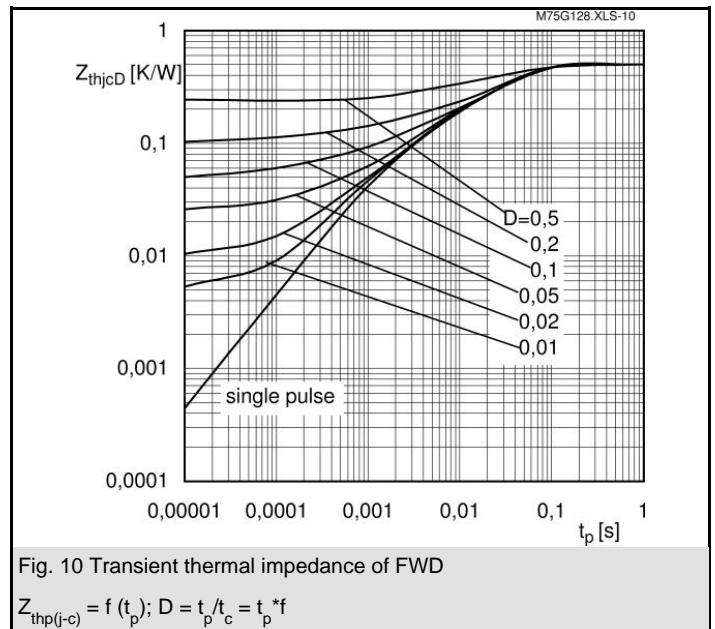
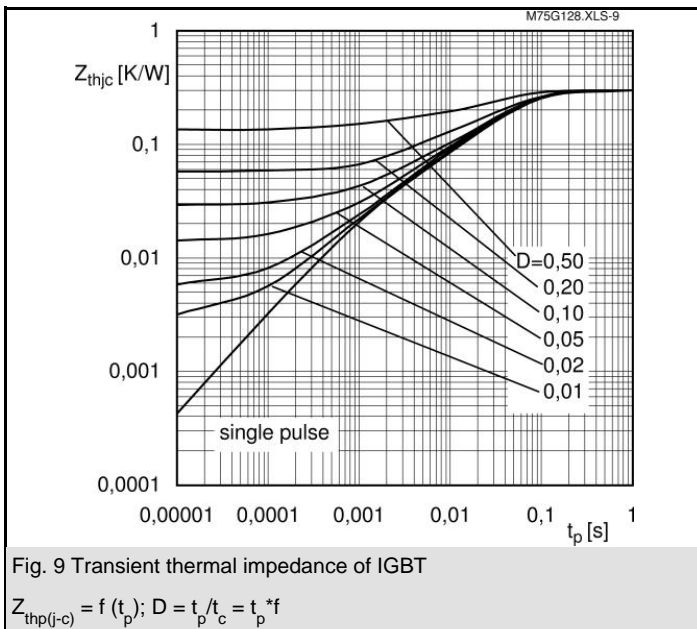
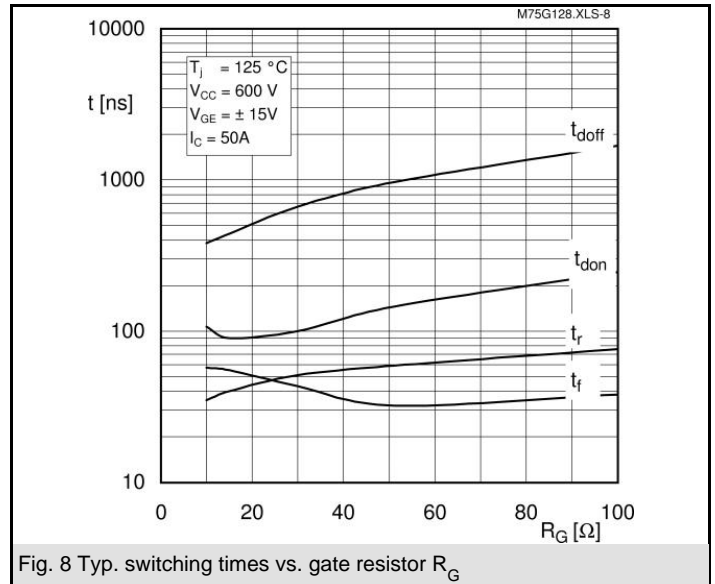
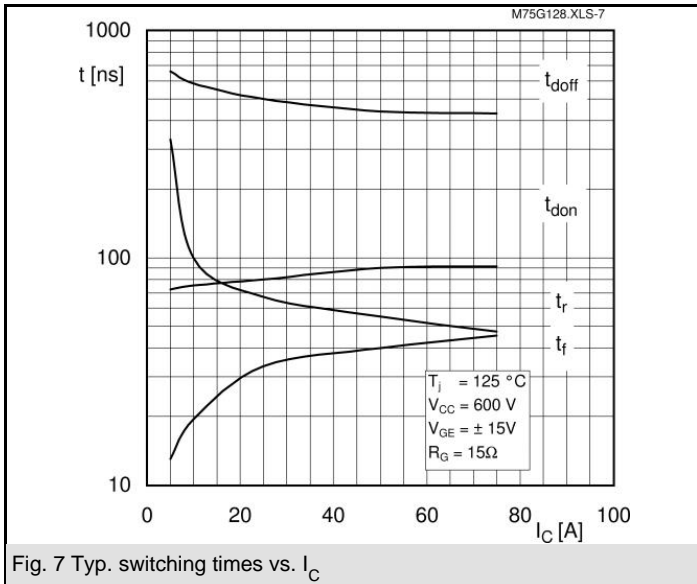

SKM 75GB128DN

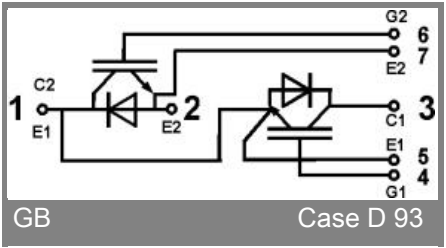
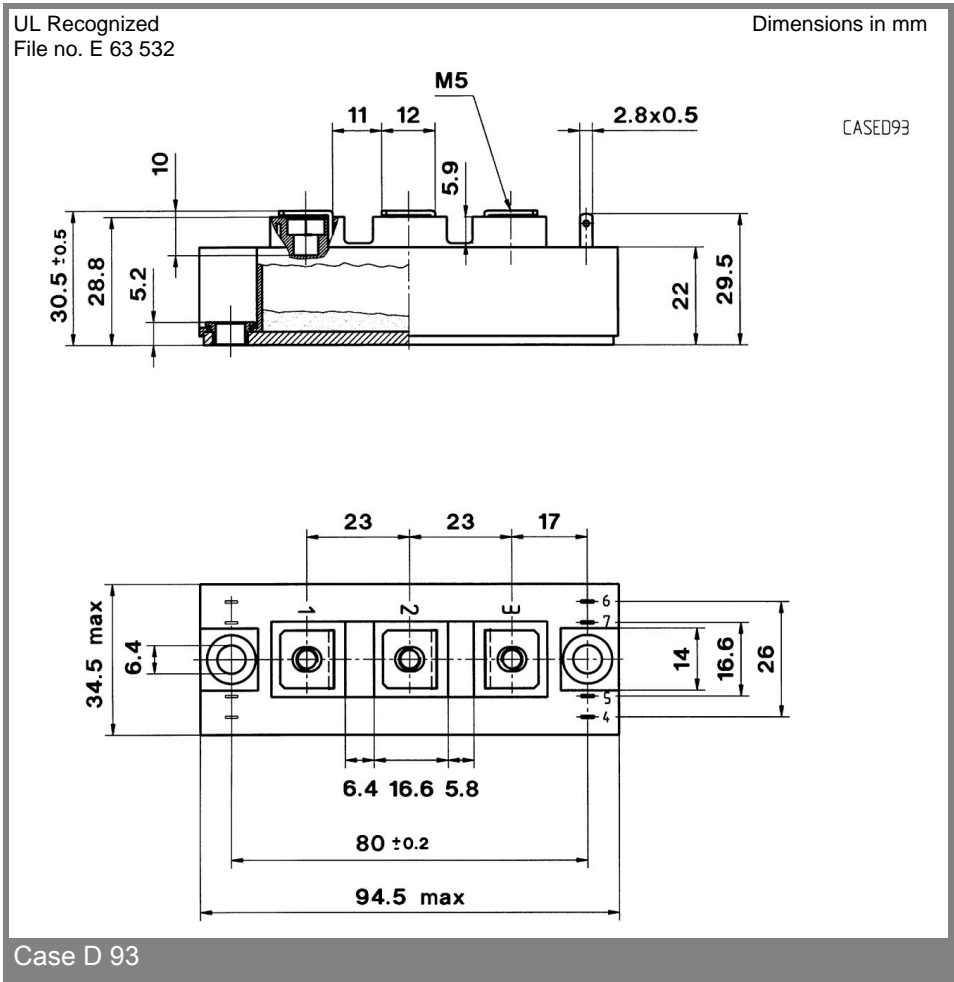
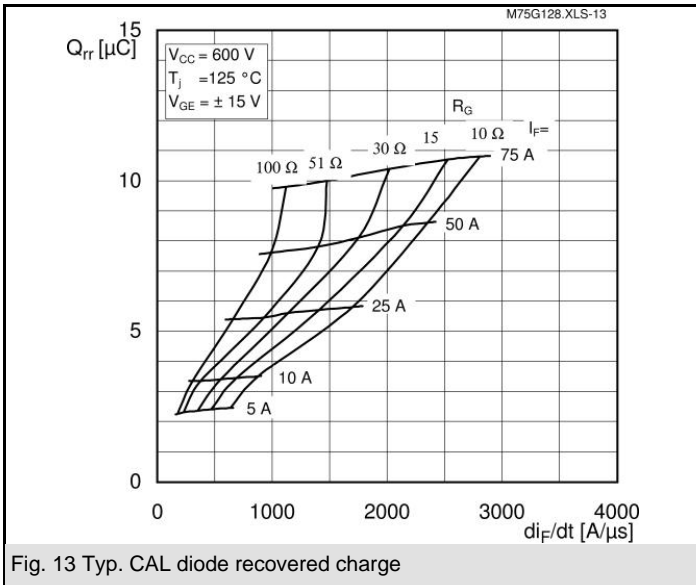

This is an electrostatic discharge sensitive device (ESDS), international standard IEC 60747-1, Chapter IX.

This technical information specifies semiconductor devices but promises no characteristics. No warranty or guarantee expressed or implied is made regarding delivery, performance or suitability.