

Typical Applications

The HMC646LP2(E) is ideal for:

- LNA Protection & T/R Switching
- TD-SCDMA / 3G Infrastructure
- Satellite Subscriber Terminals
- Private Mobile Radio & Public Safety Handsets
- Automotive Telematics

Features

- High Input P0.1 dB: +46 dBm Tx
- Low Insertion Loss: 0.4 dB
- High IIP3: +74 dBm
- Single Positive Control: 0/+3V to 0/+8V
- Failsafe operation; Tx 'On' when unpowered
- 2x2mm DFN SMT Package

Functional Diagram

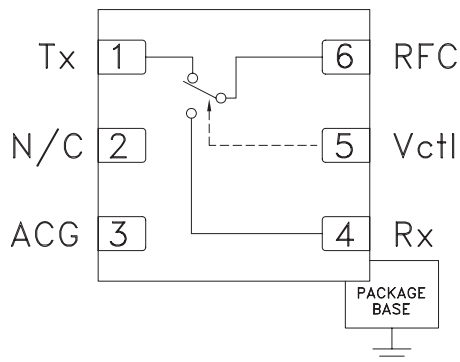

General Description

The HMC646LP2(E) is an SPDT switch in a leadless DFN surface mount plastic package for use in transmit / receive and LNA protection applications which require very low distortion and high power handling of up to 40 watts with less than 10% duty cycle. This robust switch can control signals from 100 - 2100 MHz* and is ideal for TD-SCDMA / 3G repeaters, PMR, automotive telematics, and satellite subscriber terminal applications. The design provides exceptional P0.1 dB of +46 dBm and +74 dBm IIP3 on the Transmit (Tx) port. The failsafe topology provides a low loss path from Tx to RFC, when no DC power is available.

Electrical Specifications, $T_A = +25^\circ\text{C}$, $V_{dd} = 5\text{V}$, $V_{ctl} = 0/+5\text{Vdc}$, 50 Ohm System*

| Parameter | Min. | Typ. | Max. | Min. | Typ. | Max. | Min. | Typ. | Max. | Units |
|--|--------------------------|------|------|-------------|------|------|-------------|------|------|-------|
| Frequency Range | 869 - 960 | | | 1525 - 1661 | | | 2010 - 2025 | | | MHz |
| Insertion Loss | Tx - RFC | 0.3 | 0.6 | | 0.6 | 0.9 | | 0.7 | 1.0 | dB |
| | RFC - Rx | 0.4 | 0.7 | | 0.8 | 1.1 | | 1.3 | 1.7 | dB |
| Isolation | Tx - RFC | 20 | 27 | | 15 | 22 | | 12 | 17 | dB |
| | RFC - Rx | 28 | 38 | | 20 | 30 | | 25 | 32 | dB |
| Return Loss | Tx - RFC | | 17 | | | 27 | | | 25 | dB |
| | RFC - Rx | | 25 | | | 20 | | | 12 | dB |
| Input Power for 0.1 dB Compression | Tx - RFC | | 44 | | | 46 | | | 46 | dBm |
| | RFC - Rx | | 20 | | | 20 | | | 20 | dBm |
| Input Third Order Intercept (Two-tone input power = +17 dBm each tone) | Tx - RFC | | 71 | | | 74 | | | 74 | dBm |
| | RFC - Rx | | 41 | | | 42 | | | 34 | dBm |
| Switching Characteristics | tRISE, tFALL (10/90% RF) | | 100 | | | 100 | | | 100 | ns |
| | tON, (50% CTL to 90% RF) | | 320 | | | 320 | | | 320 | ns |
| | tOFF (50% CTL to 10% RF) | | 320 | | | 320 | | | 320 | ns |

* Specifications and data reflect HMC646LP2 measured using the respective application circuits for each designated frequency band found herein



Insertion Loss vs. Temperature, Tx with 915 MHz Tuning

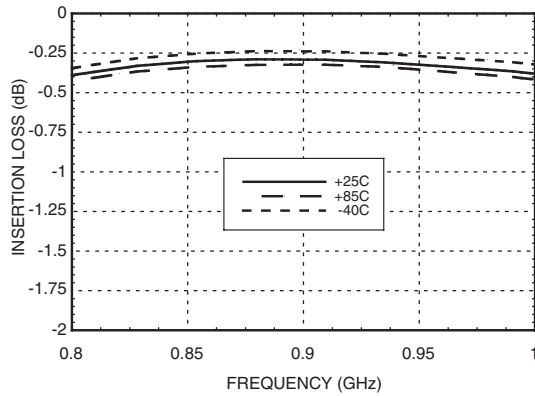

Insertion Loss vs. Temperature, Rx with 915 MHz Tuning

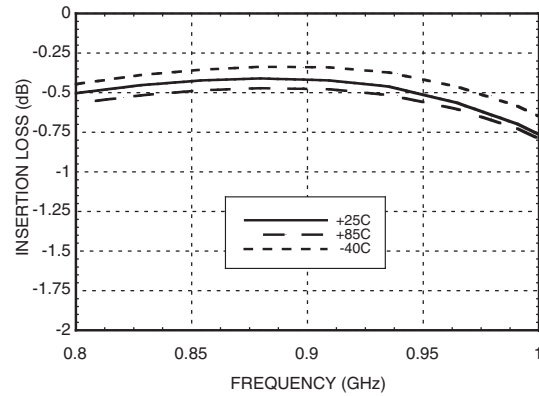

Isolation with 915 MHz Tuning

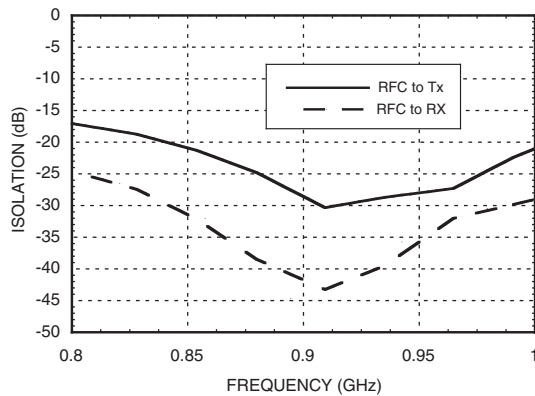

Return Loss with 915 MHz Tuning

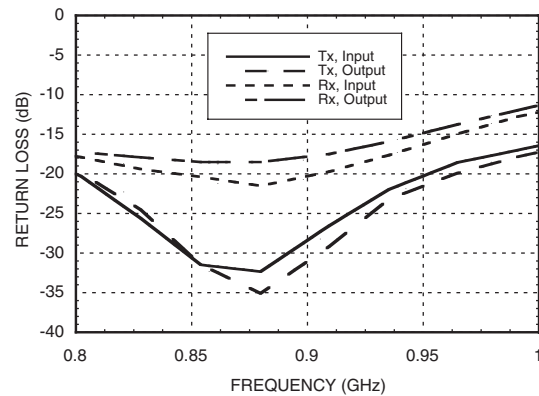

Input IP3 vs. Voltage with 915 MHz Tuning

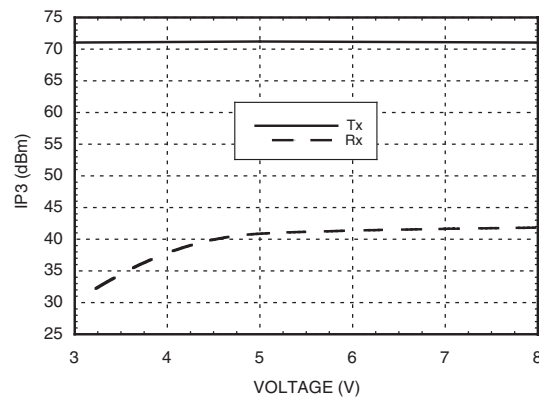



Insertion Loss vs. Temperature, Tx with 1600 MHz Tuning

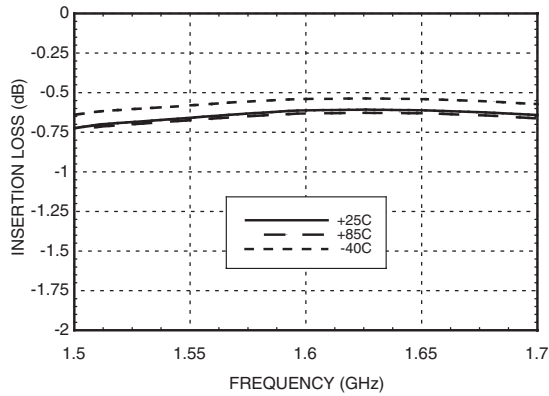

Insertion Loss vs. Temperature, Rx with 1600 MHz Tuning

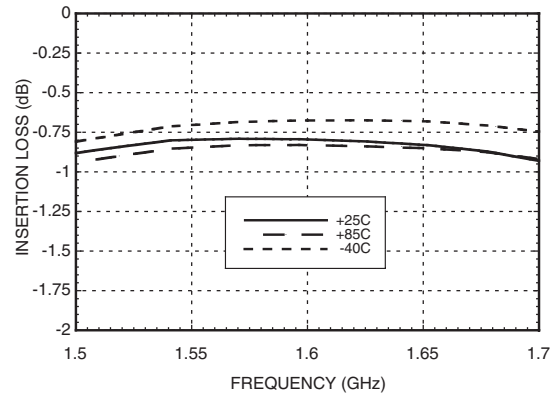

Isolation with 1600 MHz Tuning

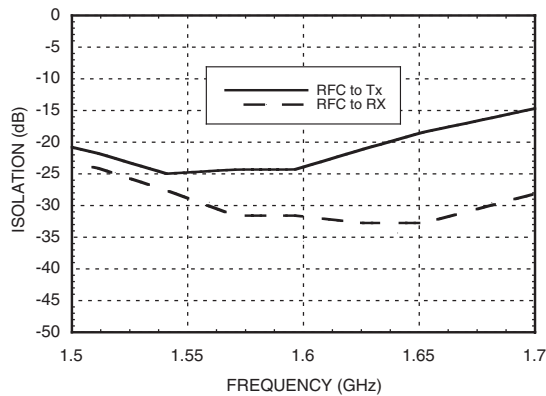

Return Loss with 1600 MHz Tuning

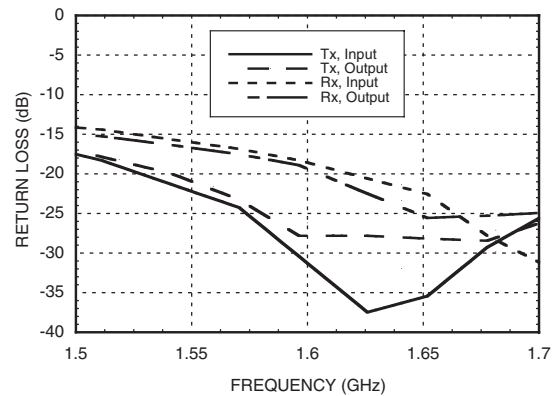

Input IP3 vs. Voltage with 1600 MHz Tuning

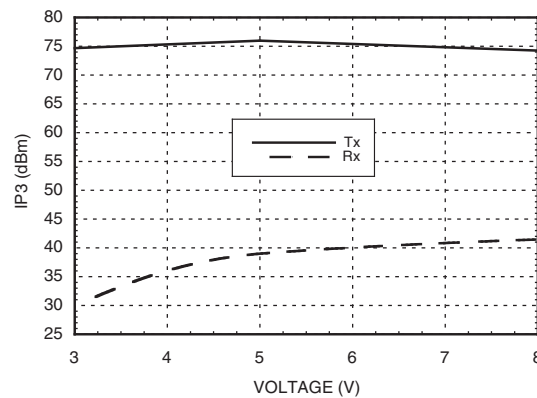



Insertion Loss vs. Temperature, Tx with 2015 MHz Tuning

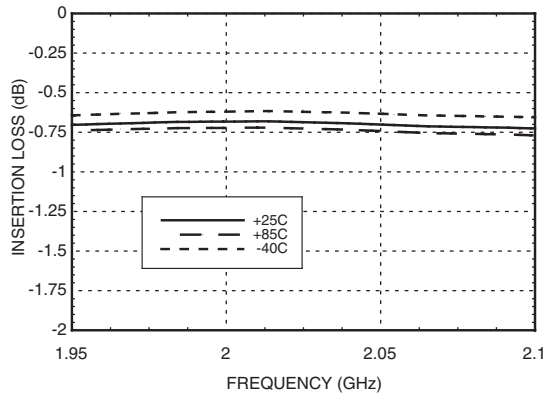

Insertion Loss vs. Temperature, Rx with 2015 MHz Tuning

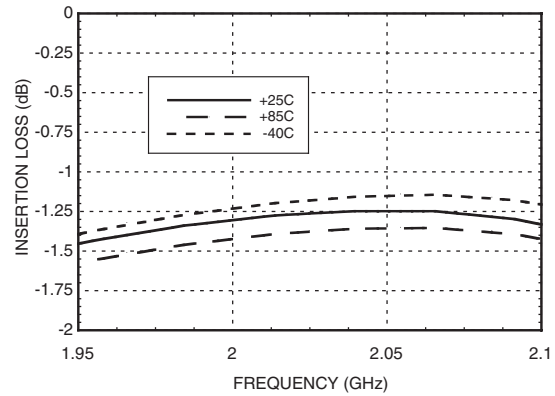

Isolation with 2015 MHz Tuning

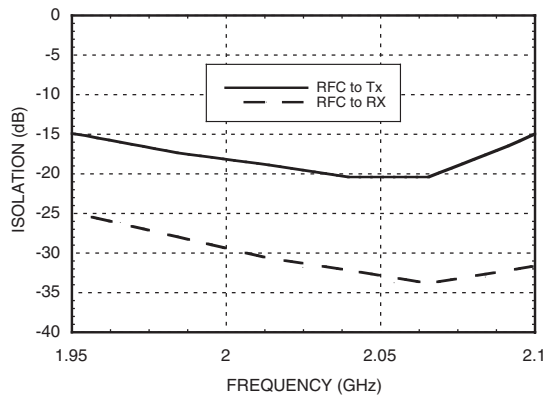

Return Loss with 2015 MHz Tuning

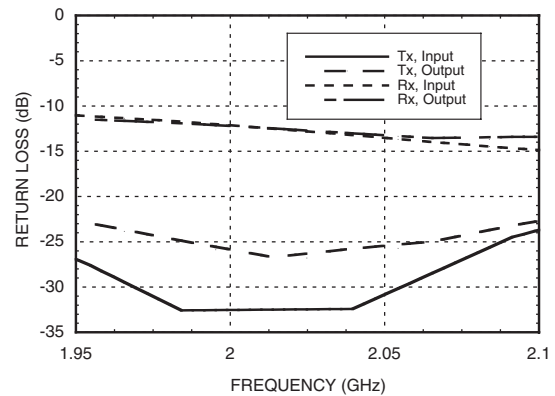

Input IP3 vs. Voltage with 2015 MHz Tuning

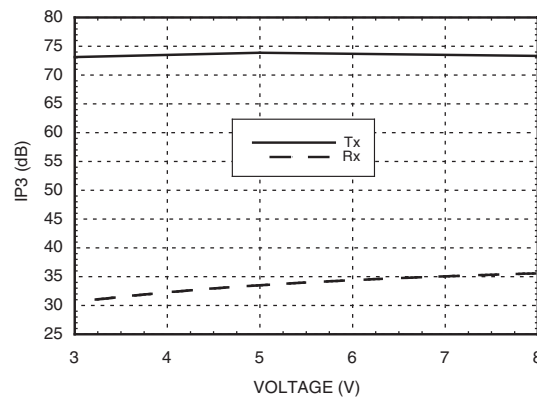

Absolute Maximum Ratings

| | | Vdd= 5V |
|------------------------------|---------|-----------------------|
| Max. CW Input Power | Tx Port | +44.00 dBm |
| | Rx Port | +36.75 dBm |
| Max Channel Temp. | | 150 °C |
| Thermal Resistance | Tx Port | 14.75 °C/W |
| | Rx Port | 14.75 °C/W |
| Continuous Dissipated Power | Tx Port | 4.4 W |
| | Rx Port | 4.4 W |
| Supply Voltage (Vdd) | | +10V Vdc |
| Control Voltage Range (Vctl) | | -0.2 to Vdd + 1.0 Vdc |
| Storage Temperature | | -65 to +150 °C |
| Operating Temperature | | -40 to +85 °C |

Truth Table

| Control Input | | Signal Path State | |
|---------------|-----|-------------------|-----------|
| Vctl | Vdd | RFC To Tx | RFC to Rx |
| 0.0 | Vdd | OFF | ON |
| Vdd | Vdd | ON | OFF |

Vdd = +3.0V to +8.0V
Control Input Voltage Tolerances are ± 0.2 Vdc.

DC blocking capacitors are required at ports RFC, Tx and Rx.



**ELECTROSTATIC SENSITIVE DEVICE
OBSERVE HANDLING PRECAUTIONS**

Outline Drawing

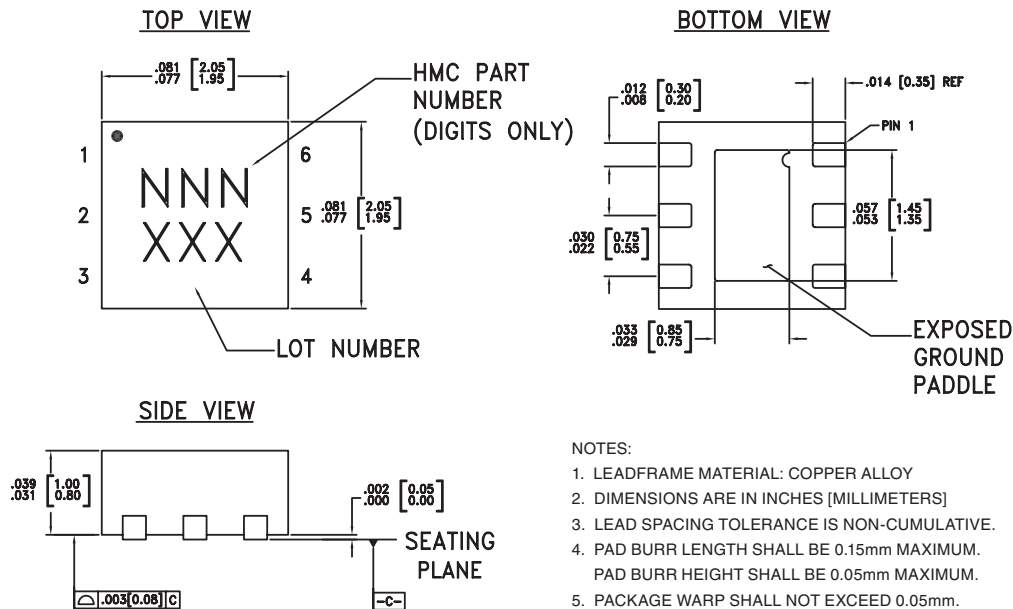

NOTES:

- LEADFRAME MATERIAL: COPPER ALLOY
- DIMENSIONS ARE IN INCHES [MILLIMETERS]
- LEAD SPACING TOLERANCE IS NON-CUMULATIVE.
- PAD BURR LENGTH SHALL BE 0.15mm MAXIMUM. PAD BURR HEIGHT SHALL BE 0.05mm MAXIMUM.
- PACKAGE WARP SHALL NOT EXCEED 0.05mm.
- ALL GROUND LEADS AND GROUND PADDLE MUST BE SOLDERED TO PCB RF GROUND.
- REFER TO HITTITE APPLICATION NOTE FOR SUGGESTED LAND PATTERN.

Package Information

| Part Number | Package Body Material | Lead Finish | MSL Rating | Package Marking ^[3] |
|-------------|---|---------------|---------------------|--------------------------------|
| HMC646LP2 | Low Stress Injection Molding Plastic | Sn/Pb Solder | MSL1 ^[1] | 646 XXX |
| HMC646LP2E | RoHS-compliant Low Stress Injection Molding Plastic | 100% matte Sn | MSL1 ^[2] | 646 XXX |

[1] Max peak reflow temperature of 235 °C



[2] Max peak reflow temperature of 260 °C

[3] 3-Digit lot number XXX

For price, delivery, and to place orders, please contact Hittite Microwave Corporation:
20 Alpha Road, Chelmsford, MA 01824 Phone: 978-250-3343 Fax: 978-250-3373
Order On-line at www.hittite.com

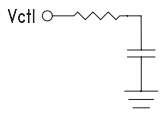

Pin Descriptions

| Pin Number | Function | Description | Interface Schematic |
|------------|----------|--|--|
| 1 | Tx | This pin is DC coupled and matched to 50 Ohms. | |
| 2 | N/C | Not Connected | |
| 3 | ACG | External capacitor to ground is required. See application circuit herein. | |
| 4 | Rx | This pin is DC coupled and matched to 50 Ohms. | |
| 5 | Vctl | See truth table. |  |
| 6 | RFC | This pin is DC coupled and matched to 50 Ohms. | |
| | GND | Package bottom has exposed metal paddle that must be connected to PCB RF ground. |  |

Application Circuit

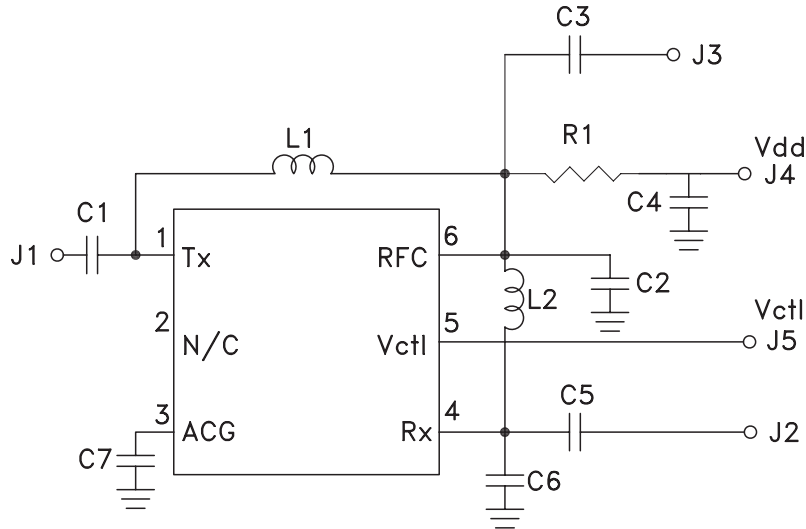

Components for Selected Frequencies

| Tuned Frequency | 915 MHz | 1600 MHz | 2015 MHz |
|-----------------------|---------|----------|----------|
| Evaluation PCB Number | 118098 | 118099 | 118100 |
| C1, C3, C5 [1] | 1000 pF | 330 pF | 330 pF |
| C2 | 2.7 pF | 1.5 pF | 1.1 pF |
| C4 | 1000 pF | 100 pF | 100 pF |
| C6 | 1.8 pF | 0.5 pF | 0.5 pF |
| C7 | 15 pF | 4.7 pF | 2.7 pF |
| L1 | 15 nH | 3.9 nH | 1.8 nH |
| L2 | 9 nH | 4.3 nH | 3.3 nH |
| R1 | 10 k | 10 k | 10 k |

[1] DC blocking capacitors

Evaluation PCB

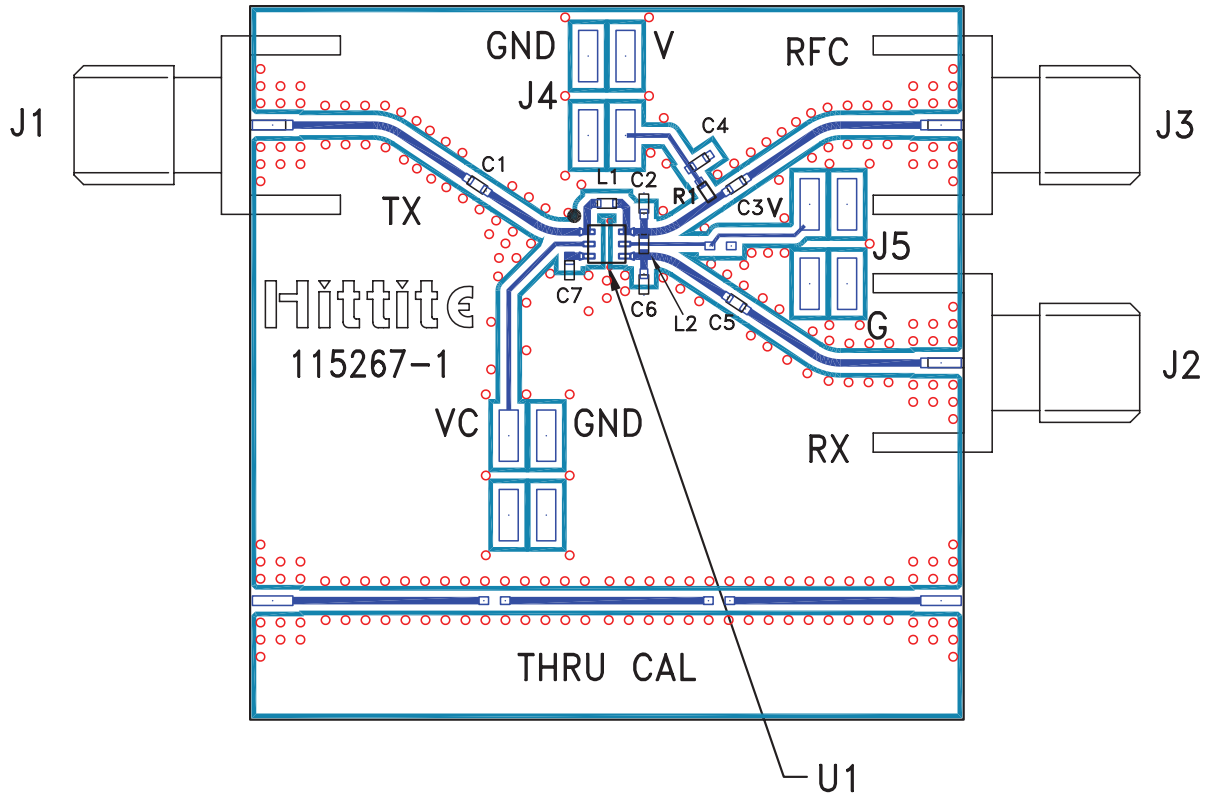

List of Materials for Evaluation PCB [1]

| Item | Description |
|-------------|----------------------------|
| J1 - J3 | PCB Mount SMA RF Connector |
| J4 - J5 | 2mm DC Header |
| C1 - C7 [2] | Capacitor, 0402 Pkg. |
| L1 - L2 [2] | Inductor, 0402 Pkg. |
| R1 [2] | Resistor, 0402 Pkg. |
| U1 | HMC646LP2(E) T/R Switch |
| PCB [3] | 110780 Evaluation PCB |

[1] When requesting an evaluation board, please reference the appropriate evaluation PCB number listed in the table "Components for Selected Frequencies."

[2] Please refer to 'Components for Selected Frequencies' table for values.

[3] Circuit Board Material: Rogers 4350

The circuit board used in the final application should be generated with proper RF circuit design techniques. Signal lines at the RF port should have 50 ohm impedance and the package ground leads and exposed paddle should be connected directly to the ground plane similar to that shown above. The evaluation circuit board shown above is available from Hittite Microwave Corporation upon request.