

FDMS9620S

Dual N-Channel PowerTrench® MOSFET

Q1: 30V, 16A, 21.5mΩ Q2: 30V, 18A, 13mΩ

Features

Q1: N-Channel

- Max $r_{DS(on)}$ = 21.5mΩ at $V_{GS} = 10V$, $I_D = 7.5A$
- Max $r_{DS(on)}$ = 29.5mΩ at $V_{GS} = 4.5V$, $I_D = 6.5A$

Q2: N-Channel

- Max $r_{DS(on)}$ = 13mΩ at $V_{GS} = 10V$, $I_D = 10A$
- Max $r_{DS(on)}$ = 17mΩ at $V_{GS} = 4.5V$, $I_D = 8.5A$
- Low Qg high side MOSFET
- Low $r_{DS(on)}$ low side MOSFET
- Thermally efficient dual Power 56 package
- Pinout optimized for simple PCB design
- RoHS Compliant



General Description

This device includes two specialized MOSFETs in a unique dual Power 56 package. It is designed to provide an optimal Synchronous Buck power stage in terms of efficiency and PCB utilization. The low switching loss "High Side" MOSFET is complemented by a Low Conduction Loss "Low Side" SyncFET.

Application

Synchronous Buck Converter for:

- Notebook System Power
- General Purpose Point of Load

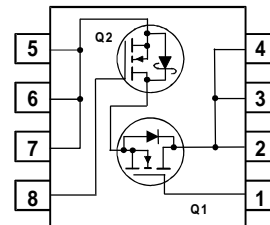
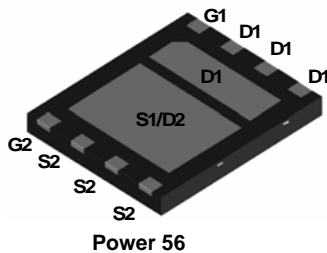

MOSFET Maximum Ratings $T_A = 25^\circ C$ unless otherwise noted

Symbol	Parameter	Q1	Q2	Units
V_{DS}	Drain to Source Voltage	30	30	V
V_{GS}	Gate to Source Voltage	± 20	± 20	V
I_D	Drain Current -Continuous (Package limited) $T_C = 25^\circ C$	16	18	A
	-Continuous (Silicon limited) $T_C = 25^\circ C$	21	44	
	-Continuous $T_A = 25^\circ C$ (Note 1a)	7.5	10	
	-Pulsed	60	60	
P_D	Power Dissipation for Single Operation $T_A = 25^\circ C$ (Note 1a)	2.5		W
	$T_A = 25^\circ C$ (Note 1b)	1		
T_J, T_{STG}	Operating and Storage Junction Temperature Range	-55 to +150		$^\circ C$

Thermal Characteristics

$R_{\theta JA}$	Thermal Resistance, Junction to Ambient	(Note 1a)	50	$^\circ C/W$
$R_{\theta JA}$	Thermal Resistance, Junction to Ambient	(Note 1b)	120	
$R_{\theta JC}$	Thermal Resistance, Junction to Case		8.2 3.1	

Package Marking and Ordering Information

Device Marking	Device	Package	Reel Size	Tape Width	Quantity
FDMS9620S	FDMS9620S	Power 56	13"	12mm	3000 units

Electrical Characteristics $T_J = 25^\circ\text{C}$ unless otherwise noted

Symbol	Parameter	Test Conditions	Type	Min	Typ	Max	Units
--------	-----------	-----------------	------	-----	-----	-----	-------

Off Characteristics

BV_{DSS}	Drain to Source Breakdown Voltage	$I_D = 250\mu\text{A}$, $V_{GS} = 0\text{V}$ $I_D = 1\text{mA}$, $V_{GS} = 0\text{V}$	Q1 Q2	30 30			V
$\frac{\Delta BV_{DSS}}{\Delta T_J}$	Breakdown Voltage Temperature Coefficient	$I_D = 250\mu\text{A}$, referenced to 25°C	Q1 Q2		23 23		mV/ $^\circ\text{C}$
I_{DSS}	Zero Gate Voltage Drain Current	$V_{DS} = 24\text{V}$, $V_{GS} = 0\text{V}$	Q1 Q2			1 500	μA
I_{GSS}	Gate to Source Leakage Current	$V_{GS} = \pm 20\text{V}$, $V_{DS} = 0\text{V}$	Q1 Q2			± 100 ± 100	nA nA

On Characteristics

$V_{GS(th)}$	Gate to Source Threshold Voltage	$V_{GS} = V_{DS}$, $I_D = 250\mu\text{A}$ $V_{GS} = V_{DS}$, $I_D = 1\text{mA}$	Q1 Q2	1 1	1.6 1.6	3 3	V
$\frac{\Delta V_{GS(th)}}{\Delta T_J}$	Gate to Source Threshold Voltage Temperature Coefficient	$I_D = 250\mu\text{A}$, referenced to 25°C $I_D = 1\text{mA}$, referenced to 25°C	Q1 Q2		-4 -4		mV/ $^\circ\text{C}$
$r_{DS(on)}$	Drain to Source On Resistance	$V_{GS} = 10\text{V}$, $I_D = 7.5\text{A}$ $V_{GS} = 4.5\text{V}$, $I_D = 6.5\text{A}$ $V_{GS} = 10\text{V}$, $I_D = 7.5\text{A}$, $T_J = 125^\circ\text{C}$	Q1		18 23 25	21.5 29.5 32	m Ω
		$V_{GS} = 10\text{V}$, $I_D = 10\text{A}$ $V_{GS} = 4.5\text{V}$, $I_D = 8.5\text{A}$ $V_{GS} = 10\text{V}$, $I_D = 10\text{A}$, $T_J = 125^\circ\text{C}$	Q2		9 13 14	13 17 22	
g_{FS}	Forward Transconductance	$V_{DS} = 10\text{V}$, $I_D = 7.5\text{A}$ $V_{DS} = 10\text{V}$, $I_D = 10\text{A}$	Q1 Q2		25 27		S

Dynamic Characteristics

C_{iss}	Input Capacitance	Q1: $V_{DS} = 15\text{V}$, $V_{GS} = 0\text{V}$, $f = 1\text{MHz}$	Q1 Q2		500 700	665 935	pF
C_{oss}	Output Capacitance	Q2: $V_{DS} = 15\text{V}$, $V_{GS} = 0\text{V}$, $f = 1\text{MHz}$	Q1 Q2		100 500	135 665	pF
C_{riss}	Reverse Transfer Capacitance	$V_{DS} = 15\text{V}$, $V_{GS} = 0\text{V}$, $f = 1\text{MHz}$	Q1 Q2		65 100	100 150	pF
R_g	Gate Resistance	$f = 1\text{MHz}$	Q1 Q2		0.9 1.8		Ω

Switching Characteristics

$t_{d(on)}$	Turn-On Delay Time	Q1: $V_{DD} = 15\text{V}$, $I_D = 1\text{A}$, $R_{GEN} = 6\Omega$	Q1 Q2		11 15	20 27	ns
t_r	Rise Time		Q1 Q2		7 13	14 24	ns
$t_{d(off)}$	Turn-Off Delay Time	Q2: $V_{DD} = 15\text{V}$, $I_D = 1\text{A}$, $R_{GEN} = 6\Omega$	Q1 Q2		23 27	37 44	ns
t_f	Fall Time		Q1 Q2		2.3 7	10 14	ns
Q_g	Total Gate Charge	Q1 $V_{DD} = 15\text{V}$, $V_{GS} = 10\text{V}$, $I_D = 7.5\text{A}$	Q1 Q2		10 18	14 25	nC
Q_{gs}	Gate to Source Gate Charge	Q2 $V_{DD} = 15\text{V}$, $V_{GS} = 10\text{V}$, $I_D = 10\text{A}$	Q1 Q2		0.7 1.5		nC
Q_{gd}	Gate to Drain "Miller" Charge		Q1 Q2		1.7 2.6		nC

Electrical Characteristics $T_J = 25^\circ\text{C}$ unless otherwise noted

Symbol	Parameter	Test Conditions	Type	Min	Typ	Max	Units
--------	-----------	-----------------	------	-----	-----	-----	-------

Drain-Source Diode Characteristics

I_S	Maximum Continuous Drain-Source Diode Forward Current		Q1 Q2			2.1 3.5	A
V_{SD}	Source to Drain Diode Forward Voltage	$V_{GS} = 0V, I_S = 2.1A$ (Note 2) $V_{GS} = 0V, I_S = 3.5A$ (Note 2)	Q1 Q2		0.7 0.5	1.2 1.0	V
t_{rr}	Reverse Recovery Time	Q1 $I_F = 7.5A, di/dt = 100A/\mu s$	Q1 Q2		13 14		ns
Q_{rr}	Reverse Recovery Charge	Q2 $I_F = 10A, di/dt = 300A/\mu s$	Q1 Q2		4 9		nC

Notes:

1: $R_{\theta JA}$ is determined with the device mounted on a 1in^2 pad 2 oz copper pad on a 1.5×1.5 in. board of FR-4 material. $R_{\theta JC}$ is guaranteed by design while $R_{\theta CA}$ is determined by the user's board design.



a. 50°C/W when mounted on a 1in^2 pad of 2 oz copper



b. 120°C/W when mounted on a minimum pad of 2 oz copper

2: Pulse Test: Pulse Width < $300\mu s$, Duty cycle < 2.0%.

Typical Characteristics (Q1 N-Channel) $T_J = 25^\circ\text{C}$ unless otherwise noted

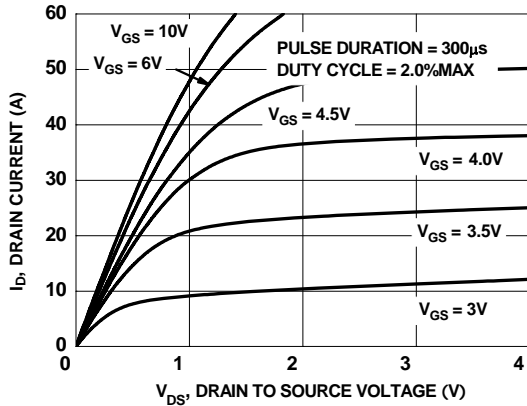

Figure 1. On Region Characteristics

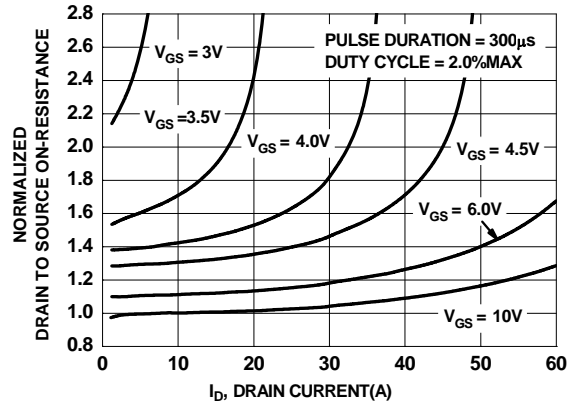

Figure 2. Normalized On-Resistance vs Drain Current and Gate Voltage

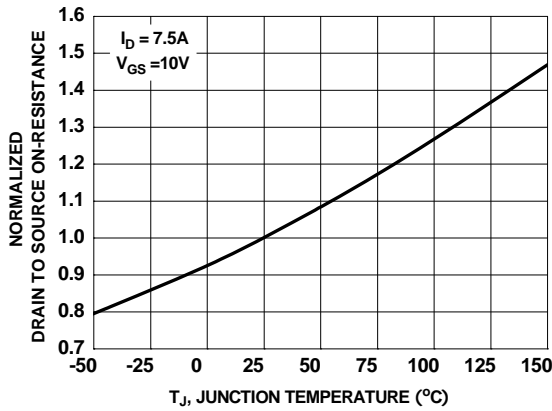

Figure 3. Normalized On Resistance vs Junction Temperature

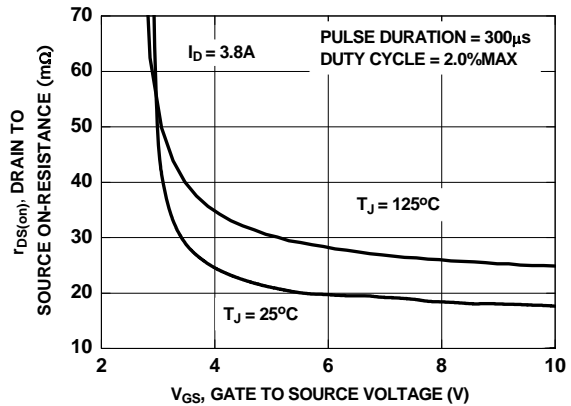

Figure 4. On-Resistance vs Gate to Source Voltage

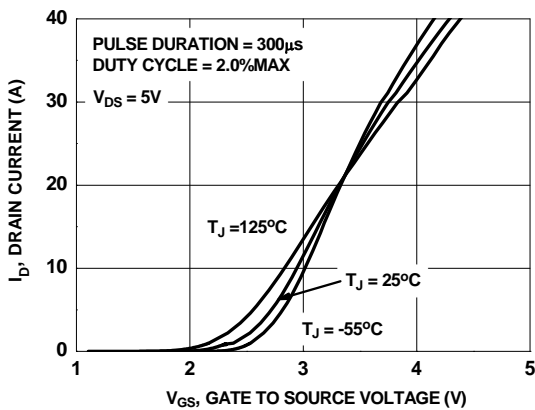

Figure 5. Transfer Characteristics

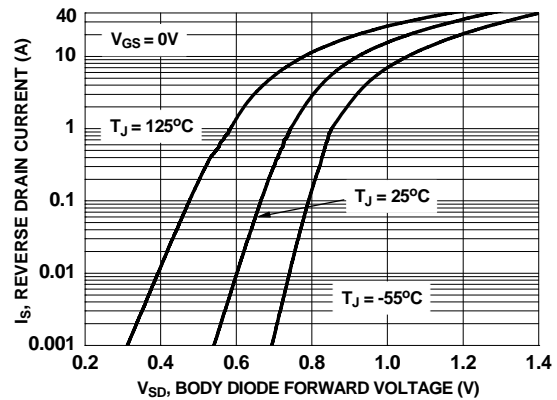

Figure 6. Source to Drain Diode Forward Voltage vs Source Current

Typical Characteristics (Q1 N-Channel) $T_J = 25^\circ\text{C}$ unless otherwise noted

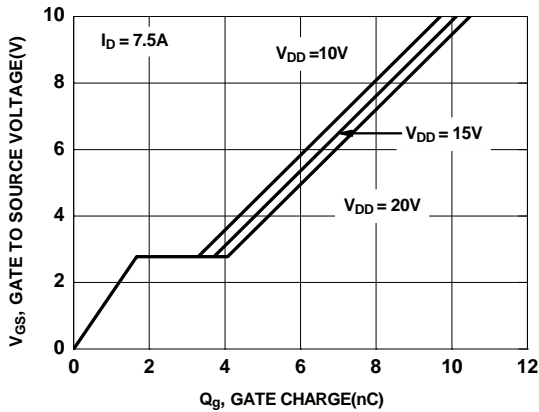

Figure 7. Gate Charge Characteristics

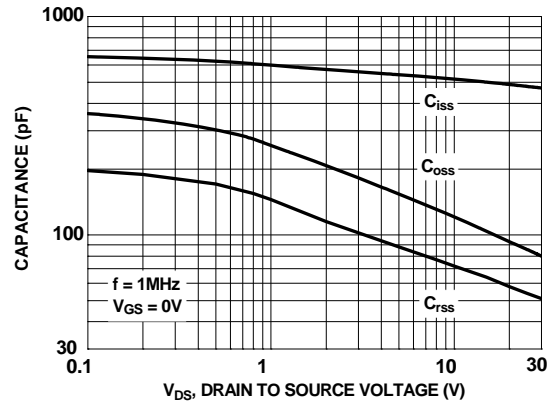

Figure 8. Capacitance vs Drain to Source Voltage

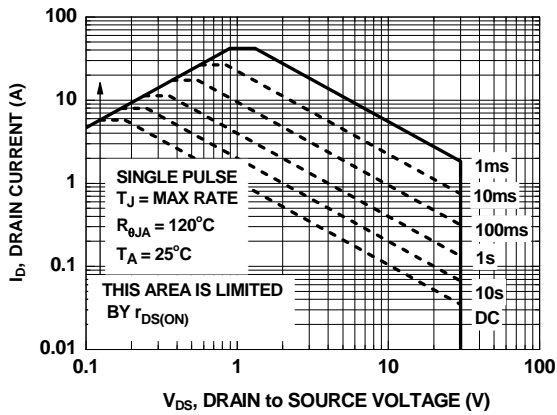

Figure 9. Forward Bias Safe Operating Area

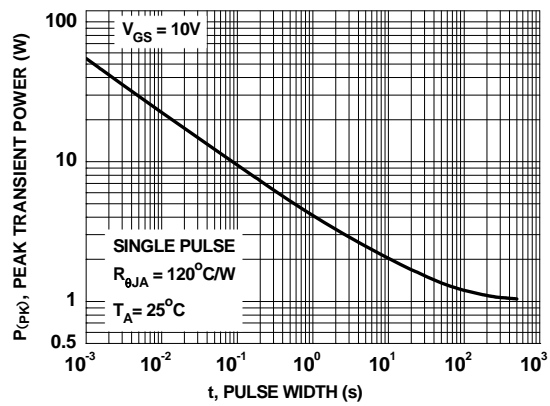

Figure 10. Single Pulse Maximum Power Dissipation

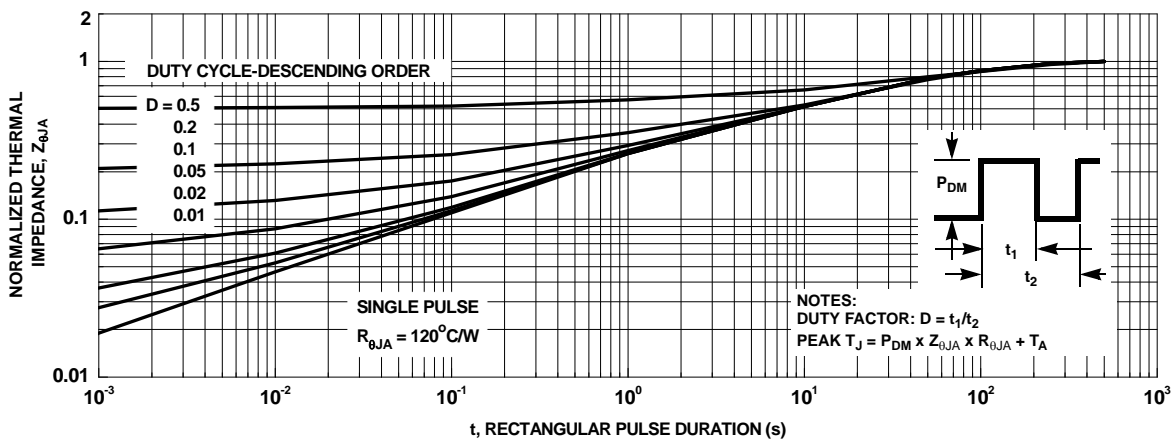

Figure 11. Transient Thermal Response Curve

Typical Characteristics (Q2 SyncFET)

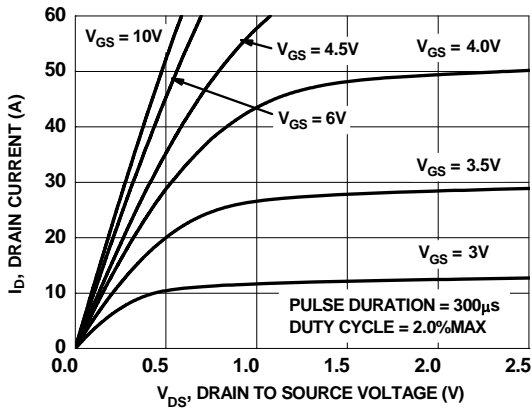

Figure 12. On-Region Characteristics

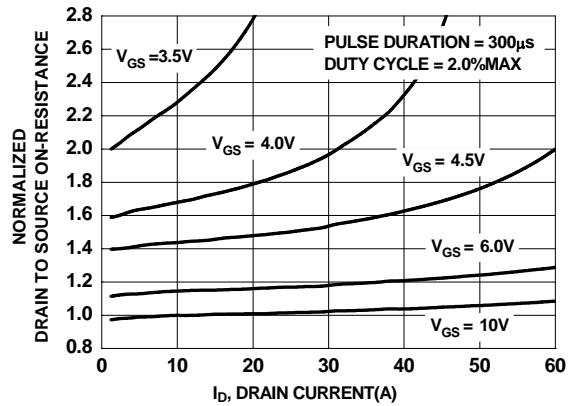

Figure 13. Normalized on-Resistance vs Drain Current and Gate Voltage

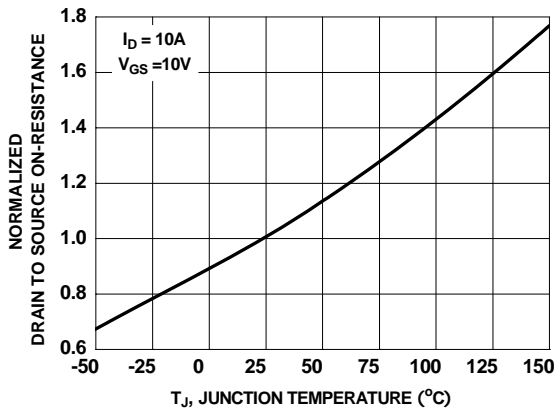

Figure 14. Normalized On-Resistance vs Junction Temperature

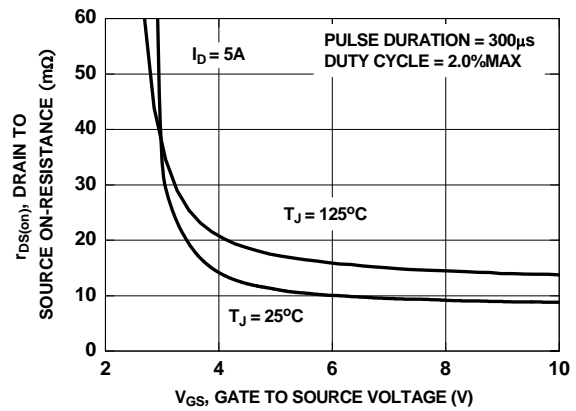

Figure 15. On-Resistance vs Gate to Source Voltage

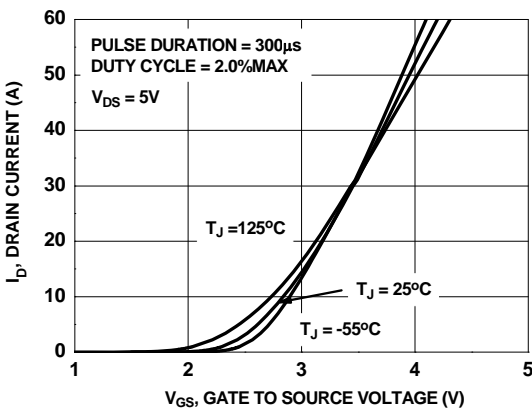

Figure 16. Transfer Characteristics

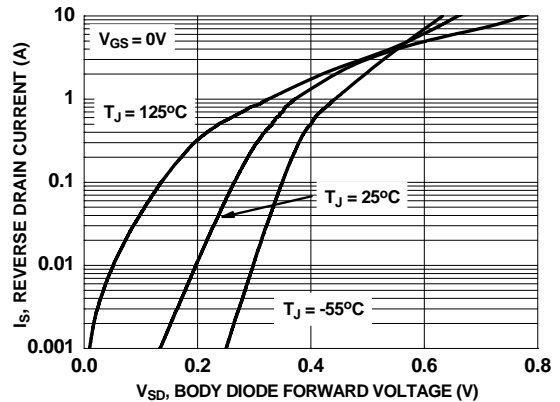

Figure 17. Source to Drain Diode Forward Voltage vs Source Current

Typical Characteristics

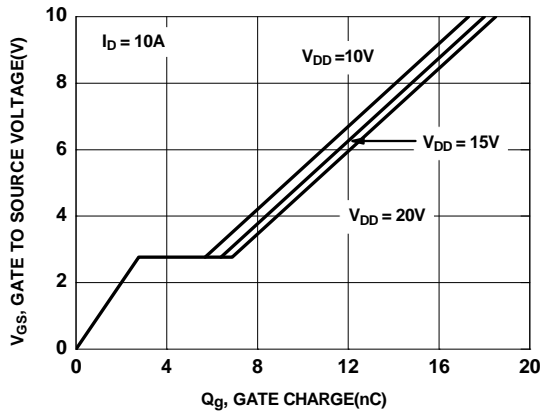

Figure 18. Gate Charge Characteristics

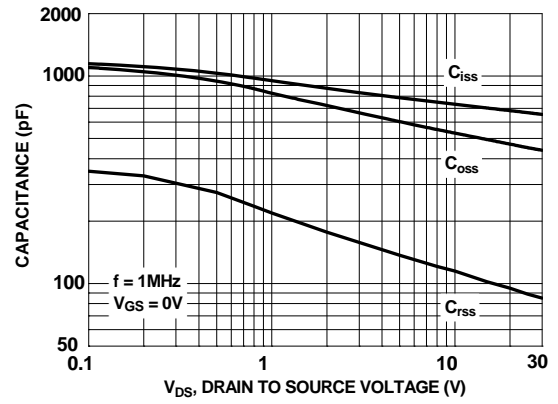
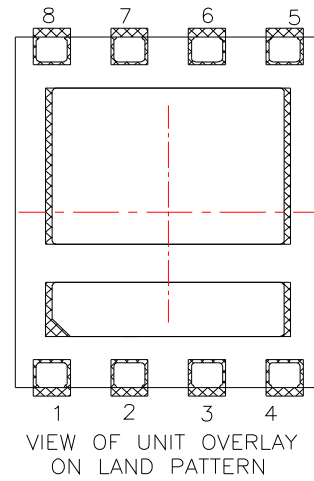
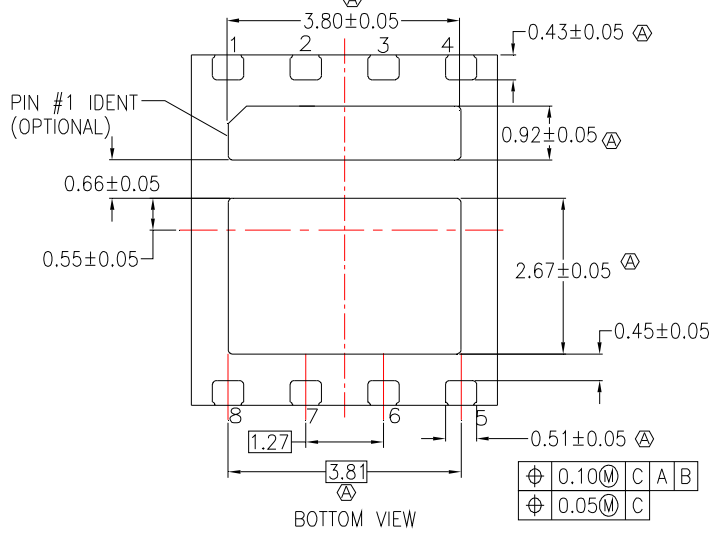
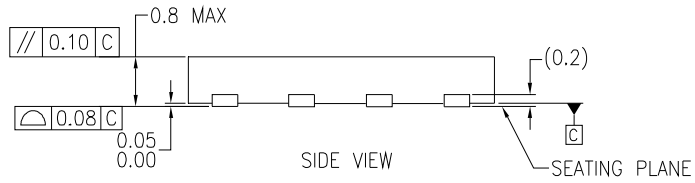
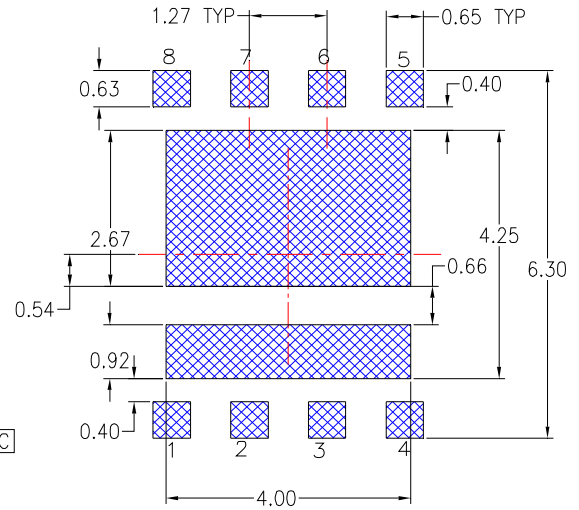
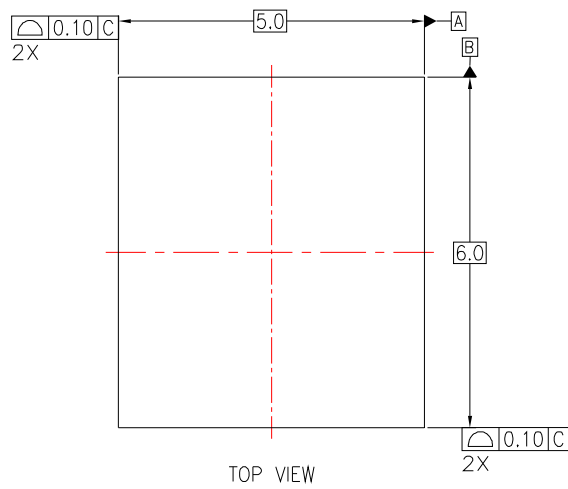

Figure 19. Capacitance vs Drain to Source Voltage

Dimensional Outline and Pad Layout



NOTES:

- Ⓐ DOES NOT FULLY CONFORM TO JEDEC REGISTRATION, MO-229, DATED 11/2001.
- B. DIMENSIONS ARE IN MILLIMETERS.
- C. DIMENSIONS AND TOLERANCES PER ASME Y14.5M, 1994

MLP08XrevA



TRADEMARKS

The following are registered and unregistered trademarks Fairchild Semiconductor owns or is authorized to use and is not intended to be an exhaustive list of all such trademarks.

ACEx®	<i>i-Lo</i> ™	Power-SPM™	TinyBoost™
Across the board. Around the world™	ImpliedDisconnect™	PowerTrench®	TinyBuck™
ActiveArray™	IntelliMAX™	Programmable Active Droop™	TinyLogic®
Bottomless™	ISOPLANAR™	QFET®	TINYOPTO™
Build it Now™	MICROCOUPLER™	QS™	TinyPower™
CoolFET™	MicroPak™	QT Optoelectronics™	TinyWire™
CROSSVOLT™	MICROWIRE™	Quiet Series™	TruTranslation™
CTL™	Motion-SPM™	RapidConfigure™	µSerDes™
Current Transfer Logic™	MSX™	RapidConnect™	UHC®
DOME™	MSXPro™	ScalarPump™	UniFET™
E ² C MOS™	OCX™	SMART START™	VCX™
EcoSPARK®	OCXPro™	SPM®	Wire™
EnSigna™	OPTOLOGIC®	STEALTH™	
FACT Quiet Series™	OPTOPLANAR®	SuperFET™	
FACT®	PACMAN™	SuperSOT™-3	
FAST®	PDP-SPM™	SuperSOT™-6	
FAST _r ™	POP™	SuperSOT™-8	
FPS™	Power220®	SyncFET™	
FRFET®	Power247®	TCM™	
GlobalOptoisolator™	PowerEdge™	The Power Franchise®	
GTO™	PowerSaver™	 ™	
HiSeC™			

DISCLAIMER

FAIRCHILD SEMICONDUCTOR RESERVES THE RIGHT TO MAKE CHANGES WITHOUT FURTHER NOTICE TO ANY PRODUCTS HEREIN TO IMPROVE RELIABILITY, FUNCTION OR DESIGN. FAIRCHILD DOES NOT ASSUME ANY LIABILITY ARISING OUT OF THE APPLICATION OR USE OF ANY PRODUCT OR CIRCUIT DESCRIBED HEREIN; NEITHER DOES IT CONVEY ANY LICENSE UNDER ITS PATENT RIGHTS, NOR THE RIGHTS OF OTHERS. THESE SPECIFICATIONS DO NOT EXPAND THE TERMS OF FAIRCHILD'S WORLDWIDE TERMS AND CONDITIONS, SPECIFICALLY THE WARRANTY THEREIN, WHICH COVERS THESE PRODUCTS.

LIFE SUPPORT POLICY

FAIRCHILD'S PRODUCTS ARE NOT AUTHORIZED FOR USE AS CRITICAL COMPONENTS IN LIFE SUPPORT DEVICES OR SYSTEMS WITHOUT THE EXPRESS WRITTEN APPROVAL OF FAIRCHILD SEMICONDUCTOR CORPORATION.

As used herein:

- Life support devices or systems are devices or systems which, (a) are intended for surgical implant into the body or (b) support or sustain life, and (c) whose failure to perform when properly used in accordance with instructions for use provided in the labeling, can be reasonably expected to result in a significant injury of the user.
- A critical component in any component of a life support, device, or system whose failure to perform can be reasonably expected to cause the failure of the life support device or system, or to affect its safety or effectiveness.

PRODUCT STATUS DEFINITIONS

Definition of Terms

Datasheet Identification	Product Status	Definition
Advance Information	Formative or In Design	This datasheet contains the design specifications for product development. Specifications may change in any manner without notice.
Preliminary	First Production	This datasheet contains preliminary data; supplementary data will be published at a later date. Fairchild Semiconductor reserves the right to make changes at any time without notice to improve design.
No Identification Needed	Full Production	This datasheet contains final specifications. Fairchild Semiconductor reserves the right to make changes at any time without notice to improve design.
Obsolete	Not In Production	This datasheet contains specifications on a product that has been discontinued by Fairchild Semiconductor. The datasheet is printed for reference information only.