

ZXMP3A16N8

30V P-CHANNEL ENHANCEMENT MODE MOSFET

SUMMARY

$V_{(BR)DSS} = -30V$; $R_{DS(ON)} = 0.040\Omega$; $I_D = -6.7A$

DESCRIPTION

This new generation of TRENCH MOSFETs from Zetex utilizes a unique structure that combines the benefits of low on-resistance with fast switching speed. This makes them ideal for high efficiency, low voltage, power management applications.

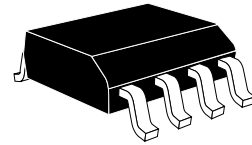

SO8

FEATURES

- Low on-resistance
- Fast switching speed
- Low threshold
- Low gate drive
- Low profile SOIC package

APPLICATIONS

- Disconnect switches
- Motor control

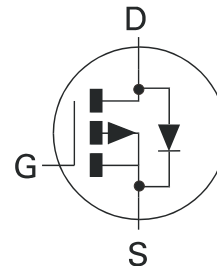

ORDERING INFORMATION

DEVICE	REEL SIZE	TAPE WIDTH	QUANTITY PER REEL
ZXMP3A16N8TA	7"	12mm	500 units
ZXMP3A16N8TC	13"	12mm	2500 units

DEVICE MARKING

- ZXMP
3A16

PINOUT

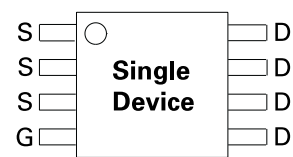

Top View

ZXMP3A16N8

ABSOLUTE MAXIMUM RATINGS.

PARAMETER	SYMBOL	LIMIT	UNIT
Drain-Source Voltage	V_{DSS}	-30	V
Gate Source Voltage	V_{GS}	± 20	V
Continuous Drain Current $V_{GS}=-10V$; $T_A=25^\circ C$ (b) $V_{GS}=-10V$; $T_A=70^\circ C$ (b) $V_{GS}=-10V$; $T_A=25^\circ C$ (a)	I_D	-6.7 -5.4 -5.6	A
Pulsed Drain Current (c)	I_{DM}	-26	A
Continuous Source Current (Body Diode) (b)	I_S	-3.2	A
Pulsed Source Current (Body Diode) (c)	I_{SM}	-26	A
Power Dissipation at $T_A=25^\circ C$ (a) Linear Derating Factor	P_D	1.9 15.2	W mW/ $^\circ C$
Power Dissipation at $T_A=25^\circ C$ (b) Linear Derating Factor	P_D	2.8 22.4	W mW/ $^\circ C$
Operating and Storage Temperature Range	$T_j; T_{stg}$	-55 to +150	$^\circ C$

THERMAL RESISTANCE

PARAMETER	SYMBOL	VALUE	UNIT
Junction to Ambient (a)	$R_{\theta JA}$	65	$^\circ C/W$
Junction to Ambient (b)	$R_{\theta JA}$	45	$^\circ C/W$

NOTES

(a) For a device surface mounted on 25mm x 25mm FR4 PCB with high coverage of single sided 1oz copper, in still air conditions

(b) For a device surface mounted on FR4 PCB measured at $t \leq 5$ secs.

(c) Repetitive rating 25mm x 25mm FR4 PCB, $D = 0.05$, pulse width $10\mu s$ - pulse width limited by maximum junction temperature. Refer to Transient Thermal Impedance graph.

ZXMP3A16N8

CHARACTERISTICS

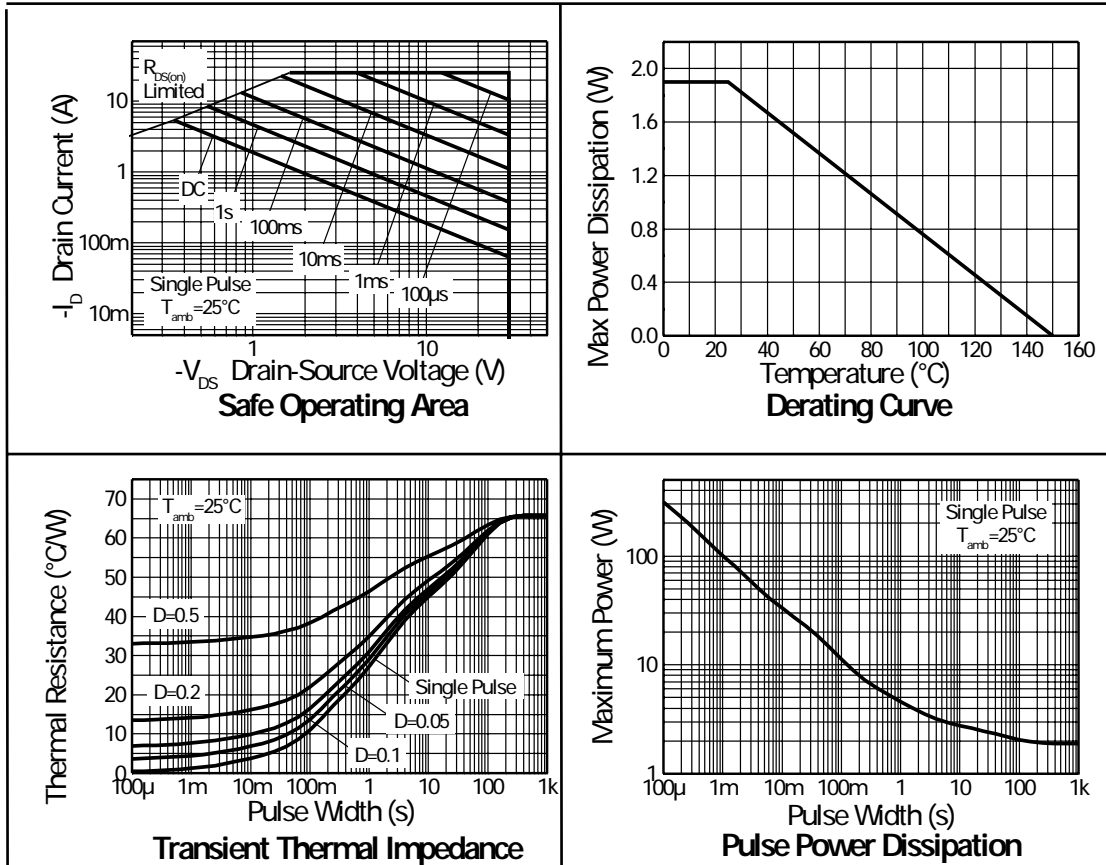

ZXMP3A16N8

ELECTRICAL CHARACTERISTICS (at $T_{amb} = 25^{\circ}\text{C}$ unless otherwise stated).

PARAMETER	SYMBOL	MIN.	TYP.	MAX.	UNIT	CONDITIONS.
STATIC						
Drain-Source Breakdown Voltage	$V_{(BR)DSS}$	-30			V	$I_D = -250\mu\text{A}, V_{GS} = 0\text{V}$
Zero Gate Voltage Drain Current	I_{DSS}			-1.0	μA	$V_{DS} = -30\text{V}, V_{GS} = 0\text{V}$
Gate-Body Leakage	I_{GSS}			100	nA	$V_{GS} = \pm 20\text{V}, V_{DS} = 0\text{V}$
Gate-Source Threshold Voltage	$V_{GS(th)}$	-1.0			V	$I_D = -250\mu\text{A}, V_{DS} = V_{GS}$
Static Drain-Source On-State Resistance (1)	$R_{DS(on)}$			0.040 0.070	Ω Ω	$V_{GS} = -10\text{V}, I_D = -4.2\text{A}$ $V_{GS} = -4.5\text{V}, I_D = -3.4\text{A}$
Forward Transconductance (1)(3)	g_{fs}		9.2		S	$V_{DS} = -15\text{V}, I_D = -4.2\text{A}$
DYNAMIC (3)						
Input Capacitance	C_{iss}		970		pF	$V_{DS} = -15\text{V}, V_{GS} = 0\text{V}, f = 1\text{MHz}$
Output Capacitance	C_{oss}		166		pF	
Reverse Transfer Capacitance	C_{rss}		116		pF	
SWITCHING(2) (3)						
Turn-On Delay Time	$t_{d(on)}$		1.95		ns	$V_{DD} = -15\text{V}, I_D = -1\text{A}$ $R_G = 6.0\Omega, V_{GS} = -10\text{V}$
Rise Time	t_r		3.82		ns	
Turn-Off Delay Time	$t_{d(off)}$		31.8		ns	
Fall Time	t_f		10.2		ns	
Gate Charge	Q_g		12.9		nC	$V_{DS} = -15\text{V}, V_{GS} = -5\text{V}, I_D = -4.2\text{A}$
Total Gate Charge	Q_g		24.9		nC	$V_{DS} = -15\text{V}, V_{GS} = -10\text{V}, I_D = -4.2\text{A}$
Gate-Source Charge	Q_{gs}		2.67		nC	
Gate-Drain Charge	Q_{gd}		3.86		nC	
SOURCE-DRAIN DIODE						
Diode Forward Voltage (1)	V_{SD}		-0.85	-0.95	V	$T_J = 25^{\circ}\text{C}, I_S = -3.6\text{A}, V_{GS} = 0\text{V}$
Reverse Recovery Time (3)	t_{rr}		21.2		ns	$T_J = 25^{\circ}\text{C}, I_F = -2\text{A}, di/dt = 100\text{A}/\mu\text{s}$
Reverse Recovery Charge (3)	Q_{rr}		18.7		nC	

NOTES

- (1) Measured under pulsed conditions. Width $\leq 300\mu\text{s}$. Duty cycle $\leq 2\%$.
 (2) Switching characteristics are independent of operating junction temperature.
 (3) For design aid only, not subject to production testing.



PROVISIONAL ISSUE A - JULY 2002

ZXMP3A16N8

CHARACTERISTICS

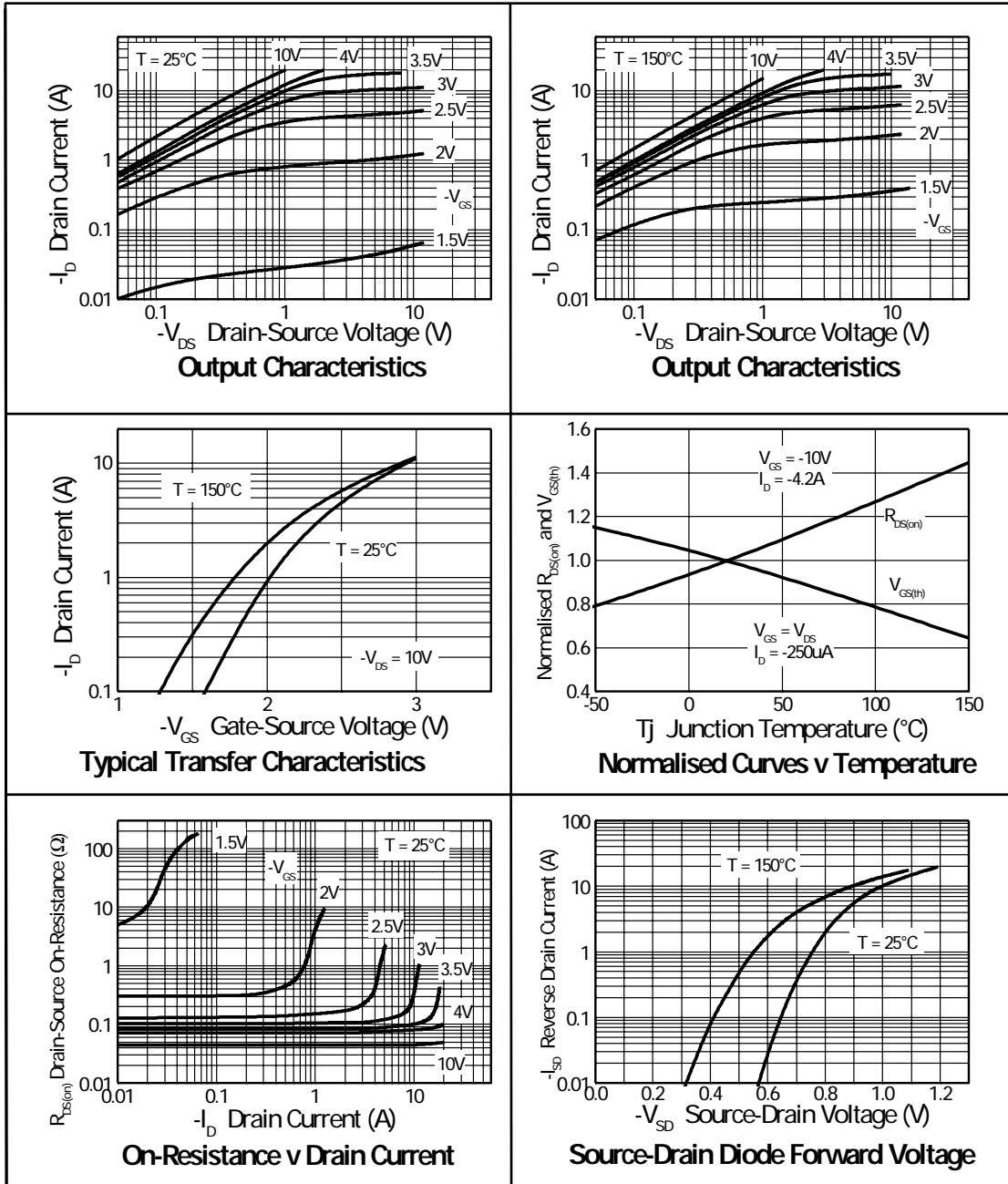

ZXMP3A16N8

CHARACTERISTICS

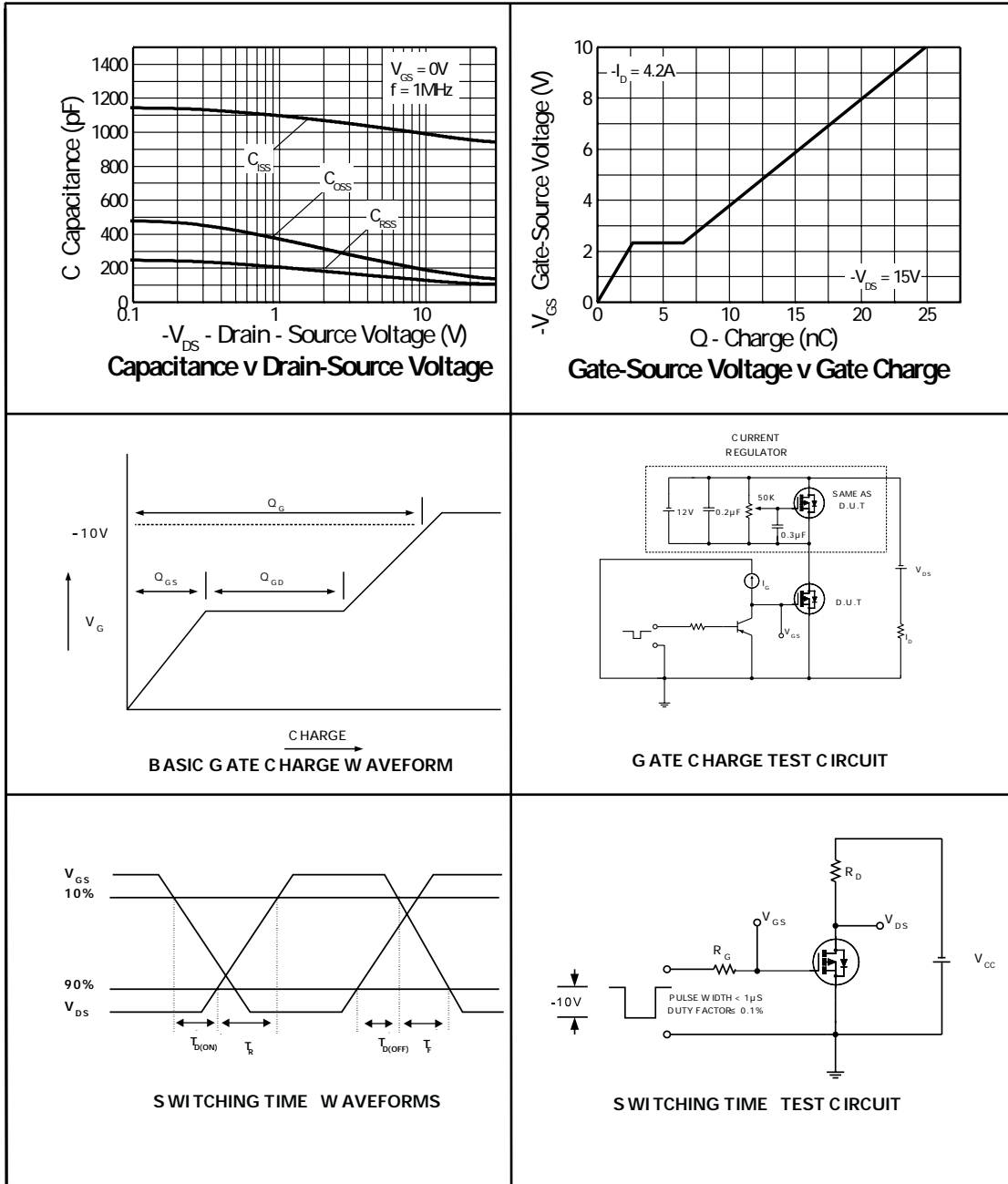

ZXMP3A16N8

PACKAGE OUTLINE

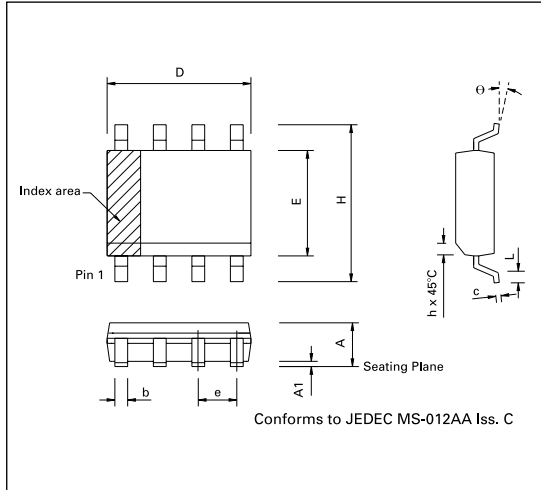

CONTROLLING DIMENSIONS ARE IN INCHES
APPROX IN MILLIMETRES

PACKAGE DIMENSIONS

DIM	INCHES		MILLIMETRES	
	MIN	MAX	MIN	MAX
A	0.053	0.069	1.35	1.75
A1	0.004	0.010	0.10	0.25
D	0.189	0.197	4.80	5.00
H	0.228	0.244	5.80	6.20
E	0.150	0.157	3.80	4.00
L	0.016	0.050	0.40	1.27
e	0.050 BSC		1.27 BSC	
b	0.013	0.020	0.33	0.51
c	0.008	0.010	0.19	0.25
θ	0°	8°	0°	8°
h	0.010	0.020	0.25	0.50

© Zetex plc 2002

Europe

Zetex plc
Fields New Road
Chadderton
Oldham, OL9 8NP
United Kingdom
Telephone (44) 161 622 4422
Fax: (44) 161 622 4420
uk.sales@zetex.com

Zetex GmbH
Streitfeldstraße 19
D-81673 München

Germany
Telefon: (49) 89 45 49 49 0
Fax: (49) 89 45 49 49 49
europe.sales@zetex.com

Americas

Zetex Inc
700 Veterans Memorial Hwy
Hauppauge, NY11788

USA
Telephone: (631) 360 2222
Fax: (631) 360 8222
usa.sales@zetex.com

Asia Pacific

Zetex (Asia) Ltd
3701-04 Metroplaza, Tower 1
Hing Fong Road
Kwai Fong
Hong Kong
Telephone: (852) 26100 611
Fax: (852) 24250 494
asia.sales@zetex.com

These offices are supported by agents and distributors in major countries world-wide.

This publication is issued to provide outline information only which (unless agreed by the Company in writing) may not be used, applied or reproduced for any purpose or form part of any order or contract or be regarded as a representation relating to the products or services concerned. The Company reserves the right to alter without notice the specification, design, price or conditions of supply of any product or service.

For the latest product information, log on to www.zetex.com

PROVISIONAL ISSUE A - JULY 2002