

ADJUSTABLE PRECISION ZENER SHUNT REGULATOR

ZR431L

Issue 1 - NOVEMBER 1998

DEVICE DESCRIPTION

The ZR431L is a three terminal adjustable shunt regulator offering excellent temperature stability and output current handling capability up to 25mA. The output voltage may be set to any chosen voltage between 1.24 and 10 volts by selection of two external divider resistors.

The devices can be used as a replacement for zener diodes in many applications requiring an improvement in zener performance.

The ZR431L is particularly used in the feedback control loop of switch mode power supplies. In this application the device 1.24 volt reference enables the generation of low voltage supplies, typically 3.3 volts or 3 volts.

FEATURES

- Surface mount SOT23 package
- TO92 package
- 2.5% and 1% tolerance
- Maximum temperature coefficient 50 ppm/°C
- Temperature compensated for operation over the full temperature range
- Programmable output voltage
- 100µA to 25mA current sink capability
- Low output noise

APPLICATIONS

- Shunt regulator
- Series regulator
- Voltage monitor
- Over voltage/ under voltage protection
- Switch mode power supplies

SCHEMATIC DIAGRAM

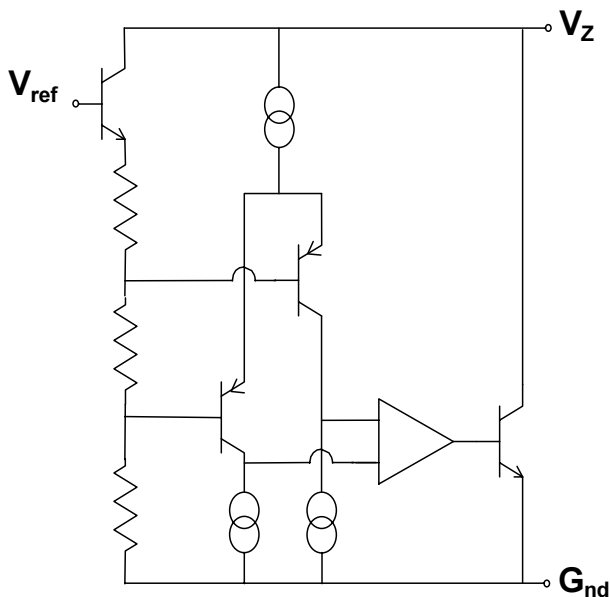

ZR431L

ABSOLUTE MAXIMUM RATING

Cathode Voltage (V _Z)	10V
Cathode Current	50mA
Operating Temperature	-40 to 85°C
Storage Temperature	-55 to 125°C

Power Dissipation (T_{amb}=25°C,
T_{jmax}=150°C)

SOT23	330mW
T092	600mW

Recommended Operating Conditions

	Min	Max
Cathode Voltage	V _{REF}	10V
Cathode Current	100μA	25mA

ELECTRICAL CHARACTERISTICS TEST CONDITIONS (Unless otherwise stated): T_{amb}=25°C

PARAMETER	SYMBOL	VALUE			UNITS	CONDITIONS
		MIN	TYP	MAX		
Reference Voltage 2.5% 1.0%	V _{ref}	1.209 1.228	1.24 1.24	1.271 1.252	V	I _L =10mA (Fig1), V _Z =V _{ref}
Deviation of Reference Input Voltage over Temperature	V _{dev}		4.0	8.0	mV	I _L =10mA, V _Z =V _{ref} T _a =full range (Fig1)
Ratio of the change in Reference Voltage to the Change in Cathode Voltage	$\frac{\Delta V_{ref}}{\Delta V_Z}$		0.5	2.0	mV/V	V _Z from V _{ref} to 10V I _Z =10mA (Fig2)
Reference Input Current	I _{ref}	0.02	0.11	0.4	μA	R1=10k, R2=OC, I _L =10mA (Fig2)
Deviation of Reference Input Current over Temperature	ΔI _{ref}		0.02	0.2	μA	R1=10k, R2=O/C, I _L =10mA T _a =full range (Fig2)
Minimum Cathode Current for Regulation	I _{Zmin}		30	100	μA	
Off-state Current	I _{Zoff}		10	30	μA	V _Z =10V, V _{ref} =0V (Fig3)
Dynamic Output Impedance	R _Z		0.25	2	Ω	V _Z =V _{ref} (Fig1), f=0Hz, I _L =10mA

Deviation of reference input voltage, V_{dev}, is defined as the maximum variation of the reference input voltage over the full temperature range.

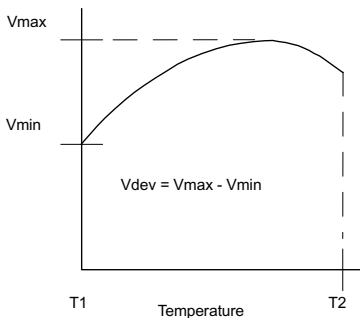

The average temperature coefficient of the reference input voltage, V_{ref} is defined as:

$$V_{ref} (ppm/^{\circ}C) = \frac{V_{dev} \times 1000000}{V_{ref} (T1 - T2)}$$

The dynamic output impedance, R_Z, is defined as:

$$R_Z = \frac{\Delta V_Z}{\Delta I_Z}$$

When the device is programmed with two external resistors, R1 and R2, (fig 2), the dynamic output impedance of the overall circuit, R', is defined as:

$$R' = R_Z \left(1 + \frac{R1}{R2}\right)$$

ZR431L

CONNECTION DIAGRAMS

SOT23 Package Suffix – F

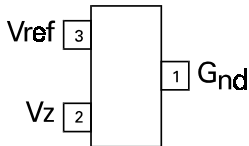

TO92 Package Suffix – C

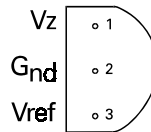

ORDERING INFORMATION

Part Number	Package	Tol %	Part Mark
ZR431LF02	SOT23	2.5	43L
ZR431LF01	SOT23	1	43M
ZR431LC02	TO92	2.5	ZR431L02
ZR431LC01	TO92	1	ZR431L01

ZR431L

TYPICAL CHARACTERISTICS

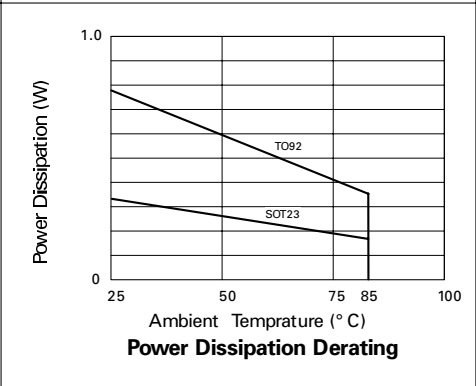
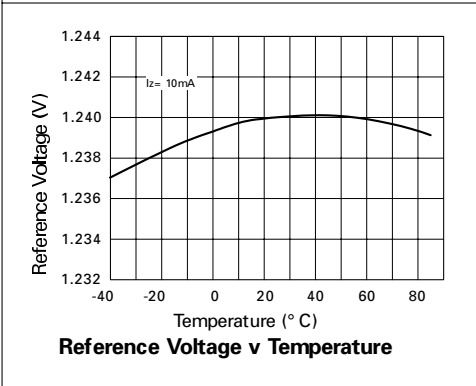
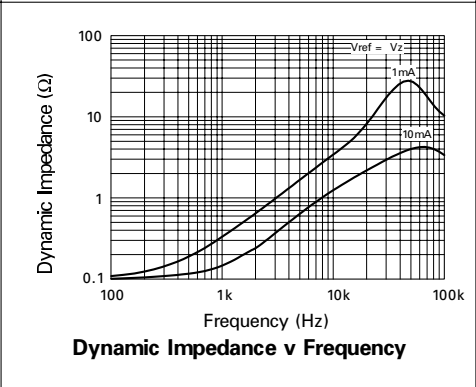
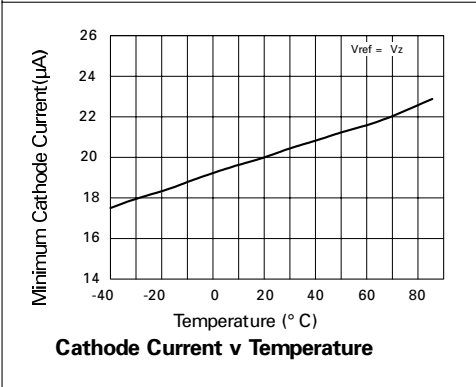
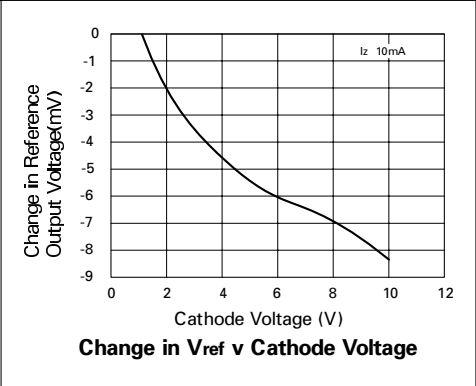
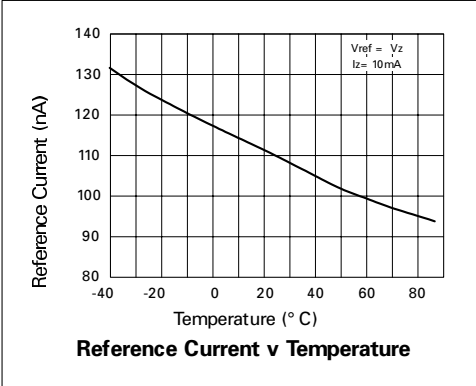

ZR431L

DC TEST CIRCUITS

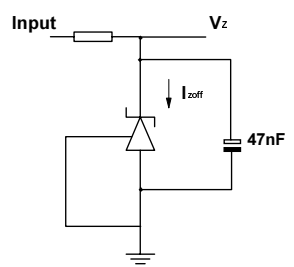
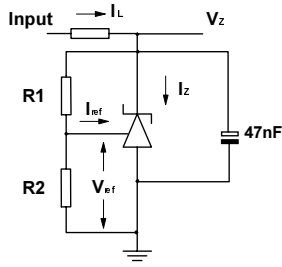
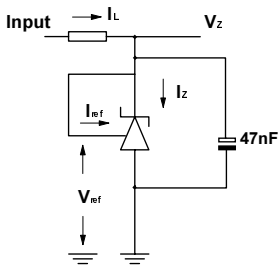

ZR431L

APPLICATION CIRCUITS

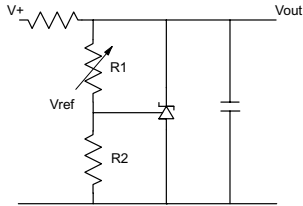

$$V_{out} = \left(1 + \frac{R1}{R2}\right) V_{ref}$$

SHUNT REGULATOR

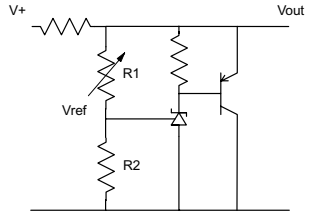

$$V_{out} = \left(1 + \frac{R1}{R2}\right) V_{ref}$$

HIGHER CURRENT SHUNT REGULATOR

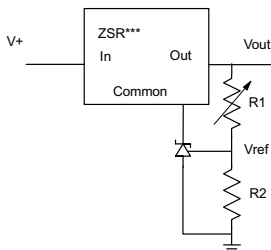

$$V_{out_MIN} = V_{ref} + V_{reg}$$

$$V_{out} = \left(1 + \frac{R1}{R2}\right) V_{ref}$$

OUTPUT CONTROL OF A THREE TERMINAL FIXED REGULATOR

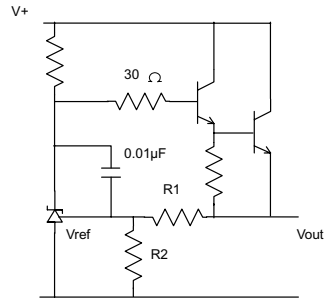

$$V_{out} = \left(1 + \frac{R1}{R2}\right) V_{ref}$$

SERIES REGULATOR

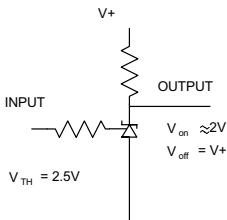

$$V_{TH} = 2.5V$$

SINGLE SUPPLY COMPARATOR WITH TEMPERATURE COMPENSATED THRESHOLD

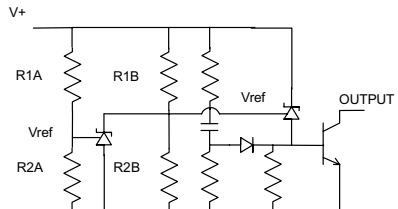

$$\text{Low limit} = \left(1 + \frac{R1B}{R2B}\right) V_{ref}$$

$$\text{High limit} = \left(1 + \frac{R1A}{R2A}\right) V_{ref}$$

OVER VOLTAGE / UNDER VOLTAGE PROTECTION CIRCUIT

TYPICAL CHARACTERISTICS

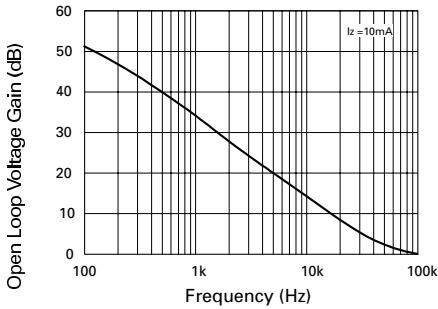

Gain v Frequency

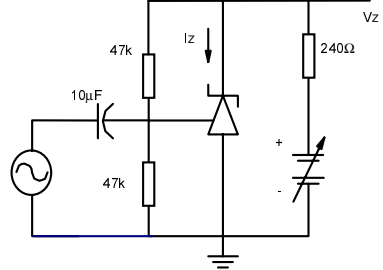

Test Circuit for Open Loop Voltage Gain

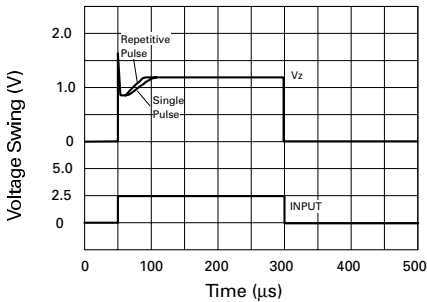

Pulse Response

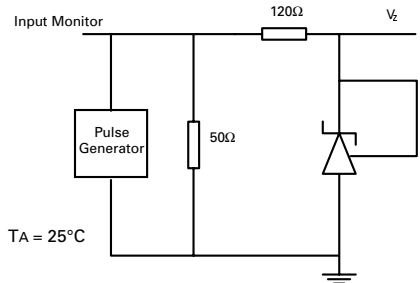

Test Circuit for Pulse Response

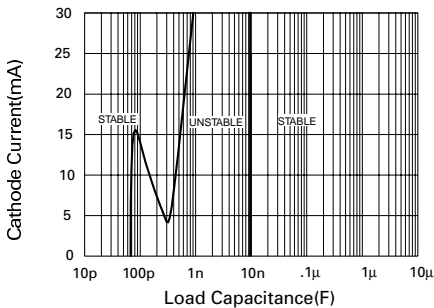

Stability Boundary Conditions

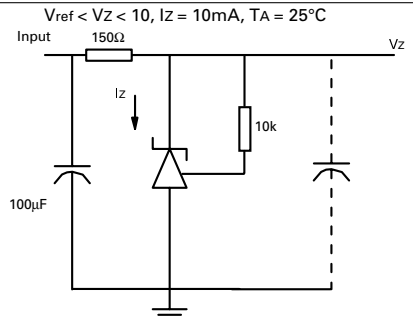

Test Circuit for Stability Boundary Conditions