

# High Efficiency PWM Step-Down DC-DC Converter

## General Description

The RT9201 is a high-efficiency pulse-width-modulated (PWM) step-down DC-DC converter. Capable of delivering 600mA output current over a wide input voltage range from 2.5 to 5.5V, the RT9201 is ideally suited for portable electronic devices that are powered from 1-cell Li-ion battery or from other power sources within the range such as cellular phones, PDAs and handy-terminals.

Four operational modes are available: PWM, PSM, Low-Dropout and shut-down modes. Internal synchronous rectifier with low  $R_{DS(ON)}$  dramatically reduces conduction loss at PWM mode. No external Schottky diode is required in practical application. The RT9201 automatically turns off the synchronous rectifier while the inductor current is low and enters discontinuous PWM mode. This can increase efficiency at light load condition. The RT9201 enters PSM (pulse-skipping mode) at extremely light load condition. The equivalent switching frequency is reduced to increase the efficiency in PSM. The RT9201 enters Low-Dropout mode when normal PWM cannot provide regulated output voltage by continuously turning on the upper P-MOSFET. RT9201 enters shut-down mode and consumes less than 0.1 $\mu$ A when EN pin is pulled low.

The switching ripple is easily smoothed-out by small package filtering elements due to a fixed operation frequency of 800kHz. This along with small VDFN package provides small PCB area application. Other features include soft start, 0.8V internal reference voltage with 1% accuracy, over temperature protection, and over current protection.

## Marking Information

For marking information, contact our sales representative directly or through a Richtek distributor located in your area, otherwise visit our website for detail.

## Features

- | **+2.5V to +5.5V Input Range**
- | **Adjustable Output From 0.85V to  $V_{IN}$**
- | **600mA Output Current**
- | **95% Efficiency**
- | **No Schottky Diode Required**
- | **85mA Quiescent Current**
- | **100% Duty Cycle in Low-Dropout Mode**
- | **800kHz Fixed-Frequency PWM Operation**
- | **Pulse-skipping Mode Operation During Light load**
- | **RoHS Compliant and 100% Lead (Pb)-Free**

## Applications

- | Cellular Telephones
- | Wireless Modems
- | Personal Information Appliances
- | Portable Instruments
- | Distributed Power Systems
- | Battery-Powered Equipment  
(1 Li-Ion or 3 NiMH/NiCd)

## Pin Configurations

(TOP VIEW)

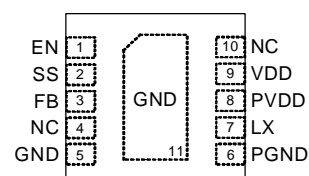

VDFN-10L 3x3

## Ordering Information

- RT9201 □ □
- Package Type  
QV : VDFN-10L 3x3 (V-Type)
  - Operating Temperature Range  
P : Pb Free with Commercial Standard  
G : Green (Halogen Free with Commercial Standard)

Note :

Richtek Pb-free and Green products are :

- } RoHS compliant and compatible with the current requirements of IPC/JEDEC J-STD-020.
- } Suitable for use in SnPb or Pb-free soldering processes.
- } 100% matte tin (Sn) plating.

## Typical Application Circuit

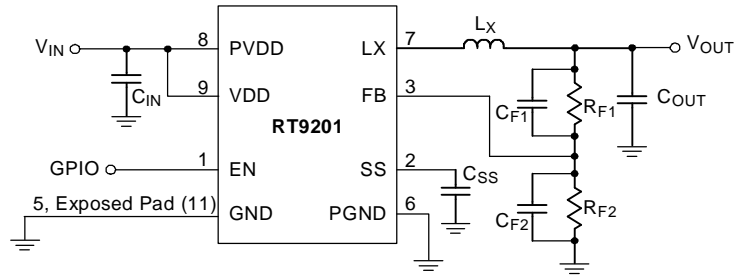

$$V_{OUT} = 0.8 \times \frac{R_{F1} + R_{F2}}{R_{F2}}$$

Recommended using lower ESR capacitor

Recommended component selection for typical application circuit.

V <sub>OUT</sub> (V)	V <sub>IN</sub> (V)	R <sub>F1</sub> (Ω)	C <sub>F1</sub> (pF)	R <sub>F2</sub> (Ω)	C <sub>F2</sub> (pF)	L <sub>X</sub> (mH)	C <sub>SS</sub> (pF)	C <sub>IN</sub> (uF)	C <sub>OUT</sub> (uF)
0.85	2.5 to 4.0	24k	330	390k	10	4.7	330	10	22 or (10 x 2)
1.375	2.5 to 5.0	280k	33	390k	10	4.7	330	10	22 or (10 x 2)
1.5	2.5 to 5.5	343k	22	390k	10	6.8	470	10	22 or (10 x 2)
1.8	2.5 to 5.5	487k	15	390k	10	6.8	470	10	22 or (10 x 2)
2.5	3.5 to 5.5	820k	10	390k	10	10	680	10	22 or (10 x 2)
3.3	4.5 to 5.5	1.2M	5.6	390k	10	10	1000	10	22 or (10 x 2)

### Suggested Inductors

Component Supplier	Series	Inductance (μH)	ESR (mΩ)	Current Rating (mA)	Dimensions (mm)
ABC	SH4018	4.7	82	1500	4.8x4.8x1.8
		6.8	100	1150	
		10	150	1000	
	SR0302	4.7	150	1200	3x2.8x2.5
		6.8	180	1000	
		10	250	800	
TDK	SLF6028	4.7	28	1600	6x6x2.8
		6.8	35	1500	
		10	53	1300	
Coilcraft	DO1606	4.7	150	1100	6.5x5.23x2
		6.8	200	1000	
		10	300	900	

Suggested Capacitors For C<sub>IN</sub> and C<sub>OUT</sub>

Component Supplier	Part No.	Capacitance (uF)	Case Size
TDK	C2012X5R0J106M	10	0805
	C3225X5R0J226M	22	1210
Panasonic	ECJ2FB0J106M	10	0805
	ECJHVB0J226M	22	1206
TAIYO YUDEN	JMK212BJ106M	10	0805
	JMK212BJ226MG	22	0805
	JMK316BJ226ML	22	1206

**Function Block Diagram**

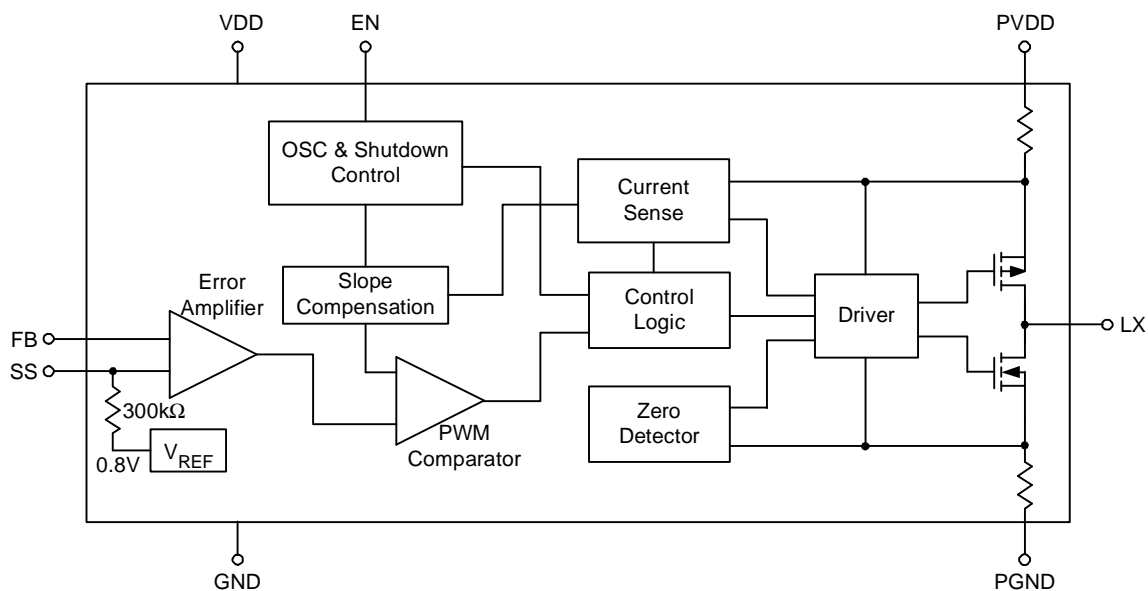

**Functional Pin Description**

Pin No.	Pin Name	Pin Function
1	EN	Tie this pin to 1.4V or higher to enable the device. Tie below 0.4V to shut-down.
2	SS	Soft Start, connect a capacitor from this pin to GND.
3	FB	Feedback Input pin. Connect a resistive voltage divider from the output voltage to FB to GND.
4, 10	NC	No Connection.
5	GND	Analog Ground.
6	PGND	Power Ground.
7	LX	Switch node. Drains of the internal P-Channel and N-Channel MOSFET switches. Connect an inductor to LX pins together as close as possible.
8	PVDD	Main Power Supply Pin.
9	VDD	Device Input Power Pin.
Exposed Pad (11)	GND	The exposed pad must be soldered to a large PCB and connected to GND for maximum power dissipation.

## Absolute Maximum Ratings (Note 1)

Input Voltage -----	6V
Power Dissipation, $P_D$ @ $T_A = 25^\circ\text{C}$	
VDFN-10L 3x3 -----	2.1W
Junction Temperature -----	150°C
Storage Temperature Range -----	-65°C to 150°C
Package Thermal Resistance	
VDFN-10L 3x3, $\theta_{JA}$ -----	47°C/W
Lead Temperature (Soldering, 10 sec.) -----	260°C
Storage Temperature Range -----	-65°C to 150°C
ESD Susceptibility (Note 2)	
HBM (Human Body Mod) -----	2kV
MM (Machine Mode) -----	200V

## Recommended Operating Conditions (Note 3)

Supply Input Voltage -----	2.5V to 5.5V
Junction Temperature Range -----	-40°C to 125°C

## Electrical Characteristics

( $V_{IN} = 3.6\text{V}$ ,  $V_{OUT} = 2.5\text{V}$ ,  $EN = V_{IN}$ ,  $L_X = 10\mu\text{H}$ ,  $C_{IN} = 10\mu\text{F}$ ,  $C_{OUT} = 22\mu\text{F}$ ,  $T_A = 25^\circ\text{C}$ , unless otherwise specified)

Parameter	Symbol	Test Conditions	Min	Typ	Max	Units
Input Voltage Range	$V_{IN}$		2.5	--	5.5	V
Adjustable Output Range	$V_{OUT}$	(Note 4)	0.85	--	$V_{IN}$	V
Reference Voltage	$V_{REF}$	$I_L = 300\text{mA}$	--	0.8	--	V
Cross Regulation	$\Delta V_{CROSS}$	$V_{IN} = 2.5\text{V to } 5.5\text{V}$ , $I_L = 600\text{mA to } 0\text{mA}$	-3	--	+3	%
FB Input Current	$I_{FB}$	$V_{FB} = V_{IN}$	-50	--	50	nA
PMOSFET $R_{ON}$	$P_{RDS(ON)}$	$I_{LX} = 200\text{mA}$	0.2	0.37	0.43	$\Omega$
NMOSFET $R_{ON}$	$N_{RDS(ON)}$	$I_{LX} = 200\text{mA}$	0.2	0.3	0.35	$\Omega$
P-Channel Current Limit	$I_{P(LM)}$	$R_L = 0.1\ \Omega$ , $V_{FB} = V_{REF} - 0.15$	0.8	1.17	1.6	A
Quiescent Current	$I_Q$	$I_{LX} = 0\text{mA}$ , $V_{FB} = V_{REF} + 0.15$	40	85	140	$\mu\text{A}$
Shutdown Current	$I_{Q(SD)}$	$EN = 0\text{V}$ , $V_{IN} = 5.5\text{V}$	0.01	2	7	$\mu\text{A}$
Oscillator Frequency	$f_{OSC}$	$I_{OUT} = 100\text{mA}$	600	800	1k	kHz
EN Input High Threshold	$V_{IH}$	$V_{IN} = 2.5\text{V to } 5.5\text{V}$	1.5	--	--	V
EN Input Low Threshold	$V_{IL}$	$V_{IN} = 2.5\text{V to } 5.5\text{V}$	--	--	0.4	V
Thermal Shutdown Temperature	$T_{SD}$		125	150	--	$^\circ\text{C}$
Maximum Duty Cycle		$V_{IN} = V_{OUT}$	100	--	--	%
Minimum On Time		No Load	0.1	0.2	0.3	$\mu\text{s}$
LX Leakage Current		$EN = 0\text{V}$ , $V_{IN} = 5.5\text{V}$ , $V_{LX} = 0\text{V}$ or $V_{LX} = 5.5\text{V}$	-20	1	20	$\mu\text{A}$

**Note 1.** Stresses listed as the above "Absolute Maximum Ratings" may cause permanent damage to the device. These are for stress ratings. Functional operation of the device at these or any other conditions beyond those indicated in the operational sections of the specifications is not implied. Exposure to absolute maximum rating conditions for extended periods may remain possibility to affect device reliability.

**Note 2.** Devices are ESD sensitive. Handling precaution recommended.

**Note 3.** The device is not guaranteed to function outside its operating conditions.

**Note 4.** Guarantee the  $V_{OUT}$  range from 0.85V to  $V_{IN}$  base on  $V_{OUT} > 0.3V_{IN}$ .

## Typical Operating Characteristics

**Frequency vs. Temperature**

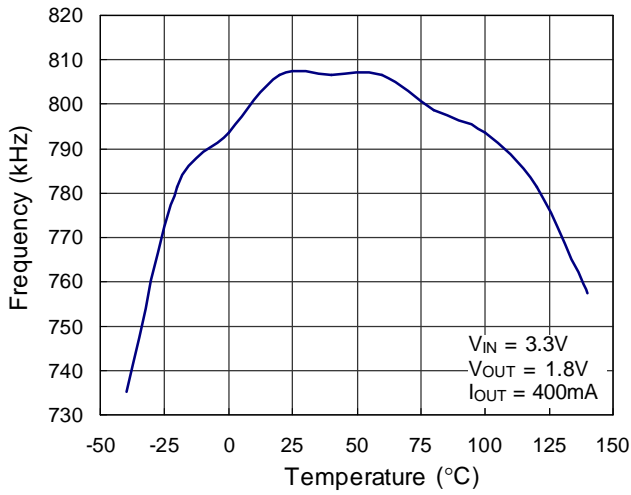

**Frequency vs. Input Voltage**

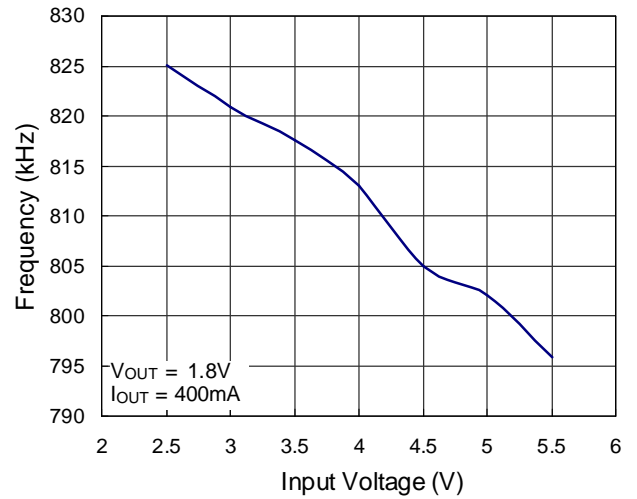

**Output Voltage vs. Temperature**

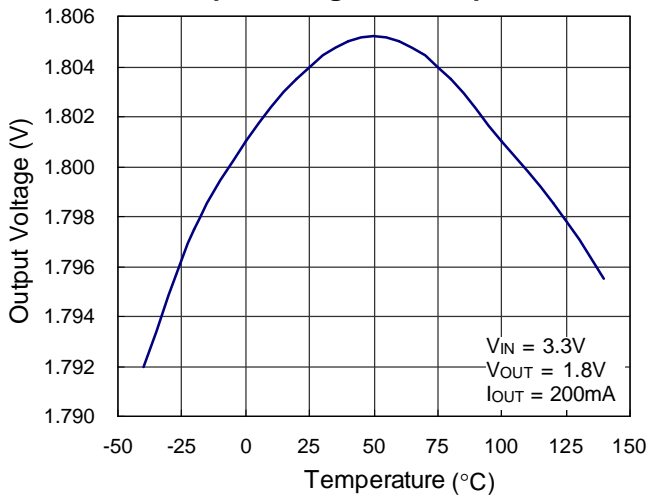

**V<sub>FB</sub> vs. Temperature**

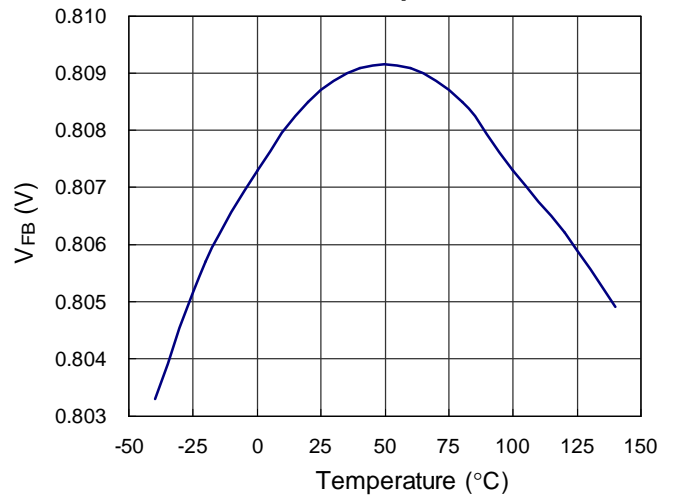

**Efficiency vs. Temperature**

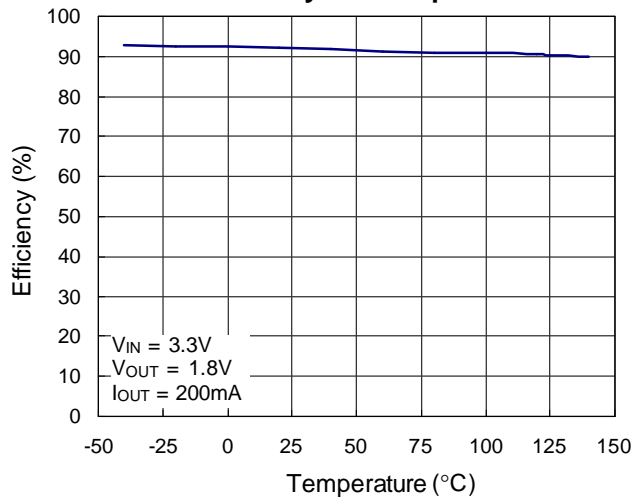

**Efficiency vs. Output Current**

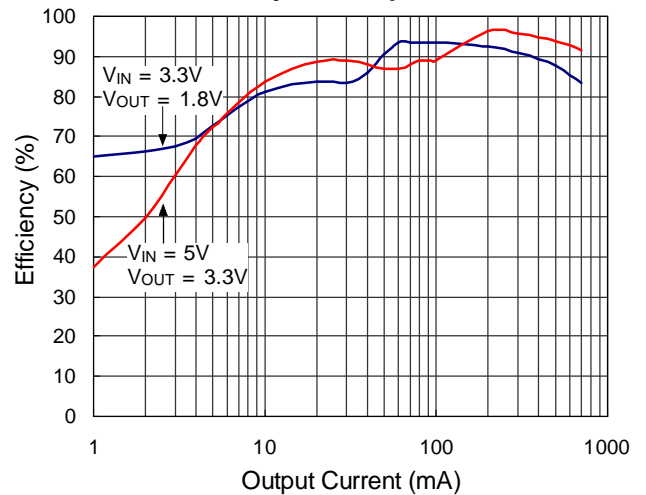

Output Voltage vs. Output Current

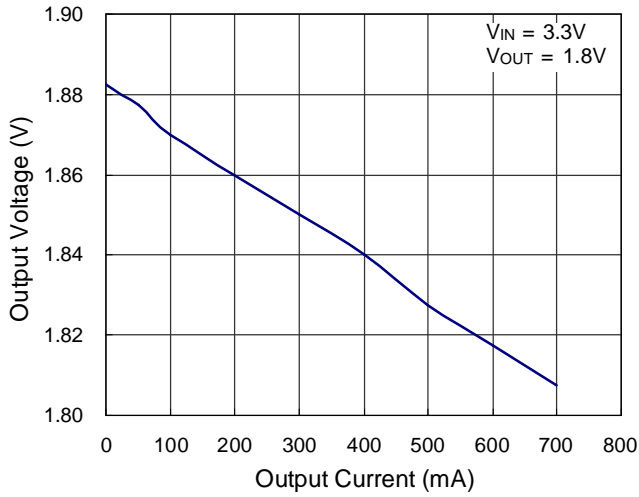

Output Voltage vs. Output Current

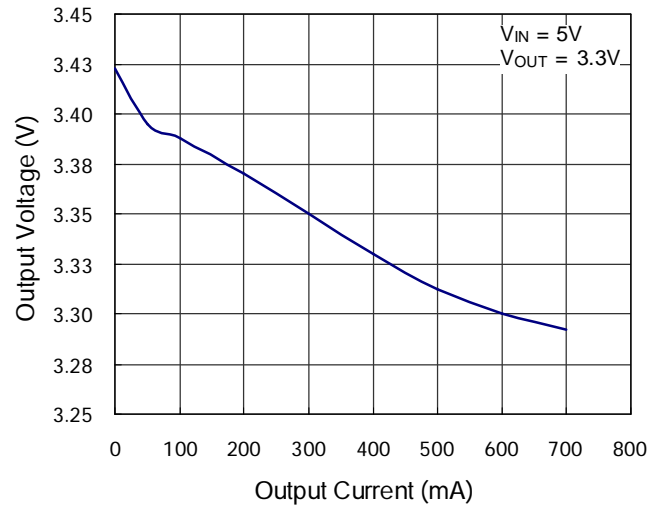

Minimum On-Time vs. Input Voltage

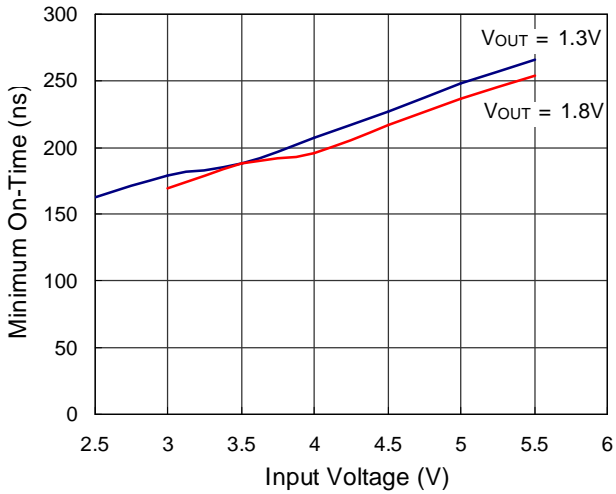

Minimum On-Time vs. Temperature

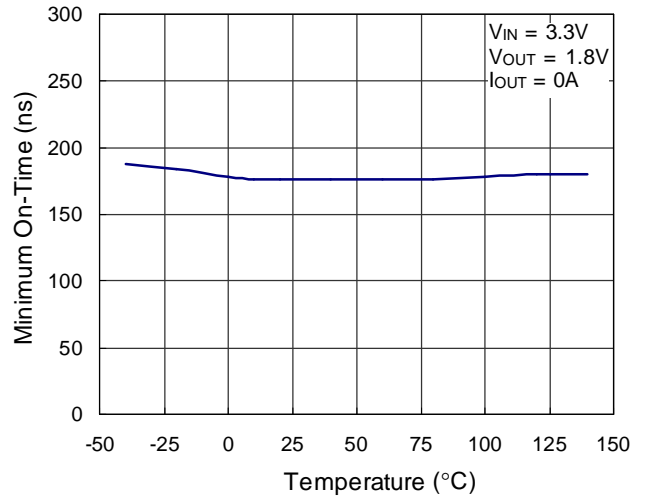

Current Limit vs. Input Voltage

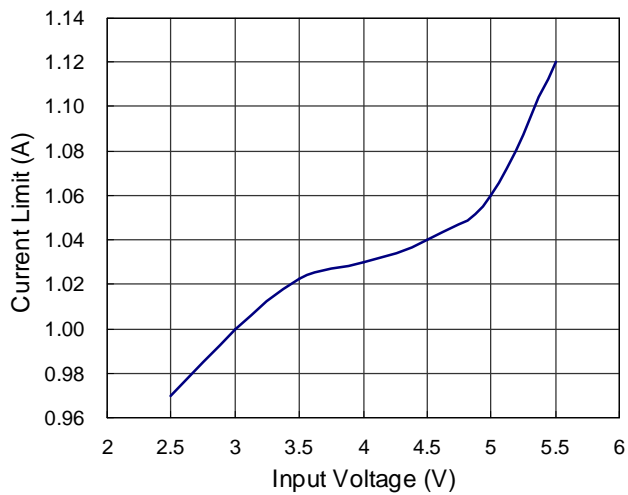

Load Transient Response

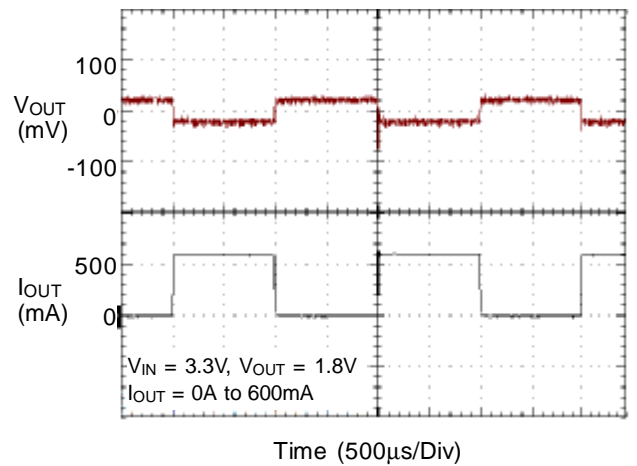

Load Transient Response

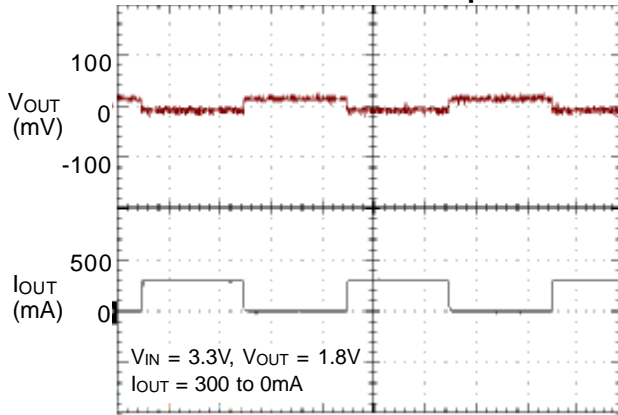

Time (500 $\mu$ s/Div)

Load Transient Response

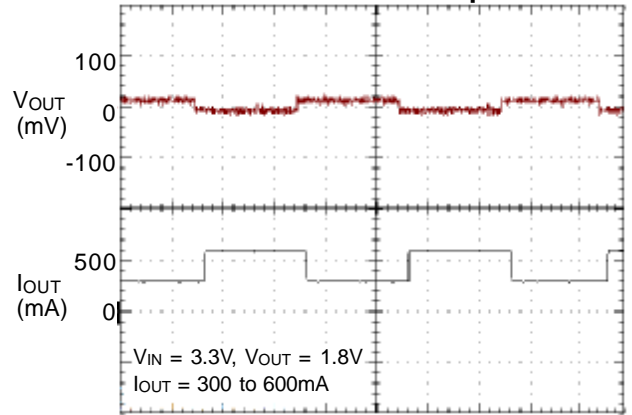

Time (500 $\mu$ s/Div)

Ripple & Noise

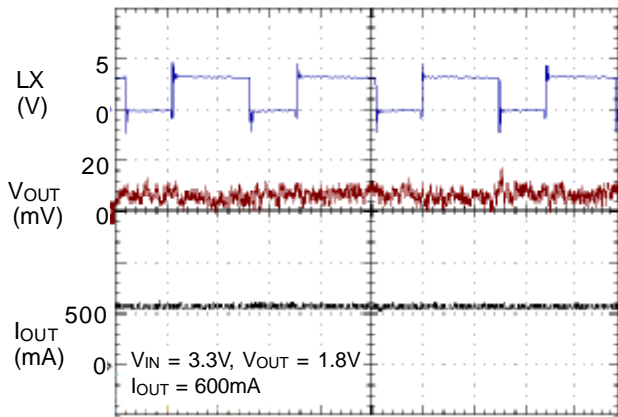

Time (500ns/Div)

Load Transient Response

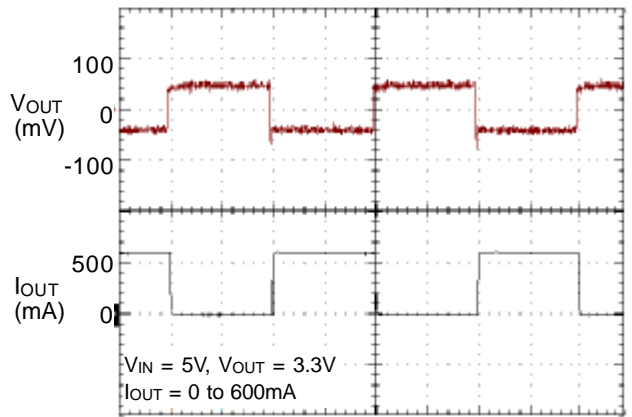

Time (500 $\mu$ s/Div)

Load Transient Response

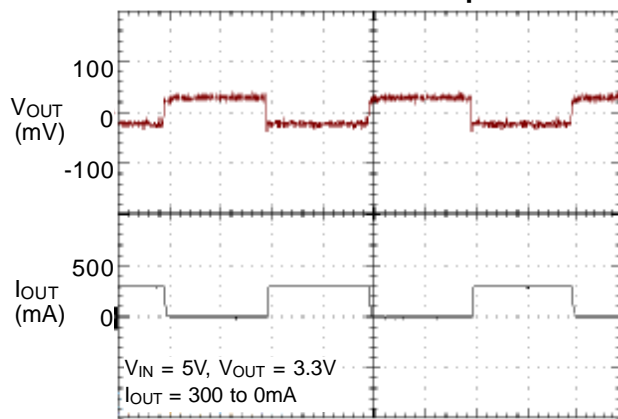

Time (500 $\mu$ s/Div)

Load Transient Response

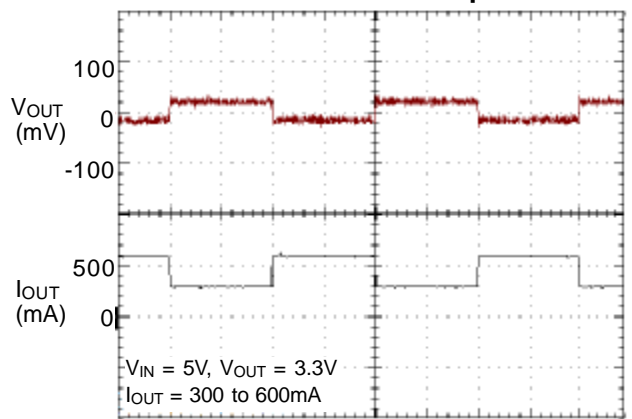

Time (500 $\mu$ s/Div)



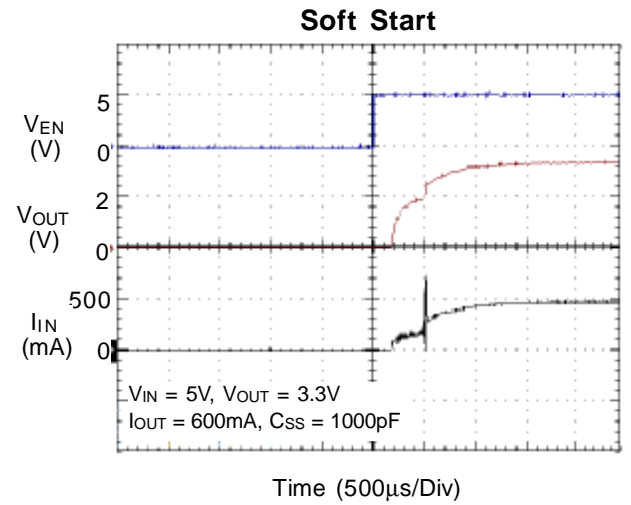
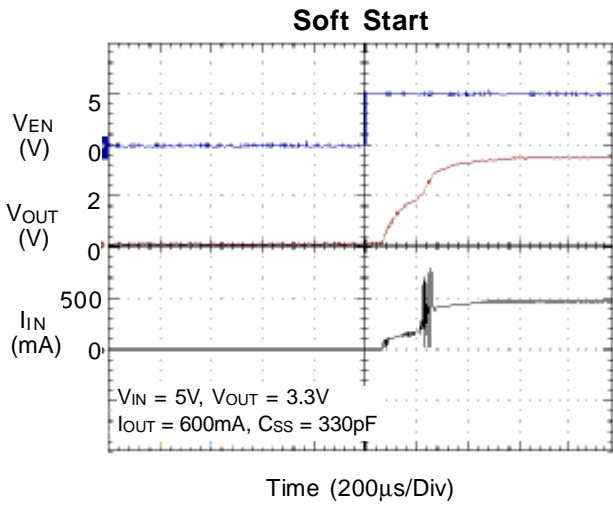
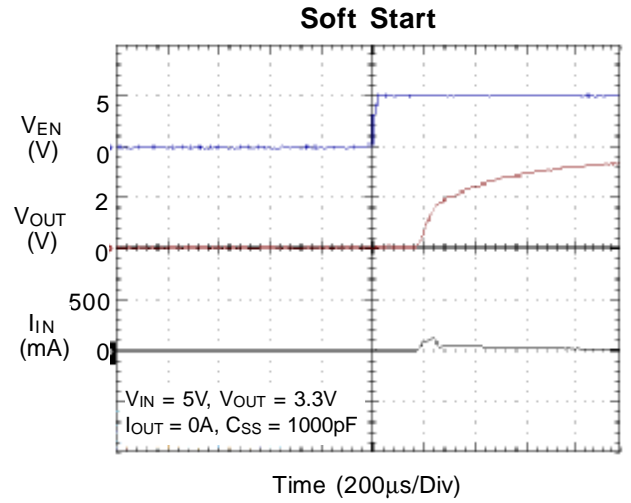
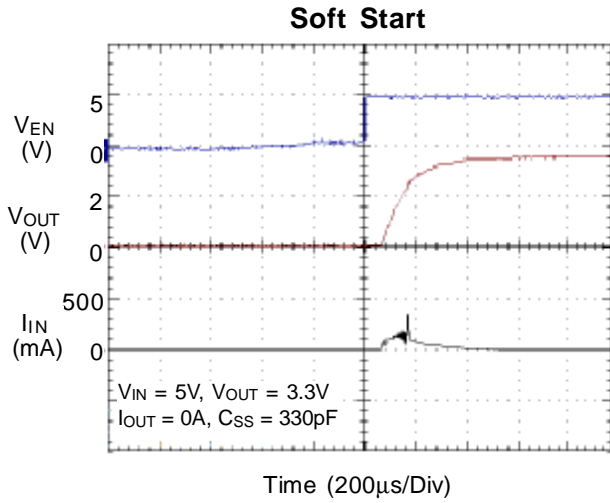

## Application Information

RT9201 is a high-efficiency pulse-width-modulated (PWM) step-down DC-DC converter. Capable of delivering 600mA output current over a wide input voltage range from 2.5V to 5.5V, the RT9201 is ideally suited for portable electronic devices that are powered from 1-cell Li-ion battery or from other power sources within the range such as cellular phones, PDAs and handy-terminals.

### Chip Enable/Disable and Soft Start

Four operational modes are available: PWM, PSM, Low-Drop-Out and shut-down modes. Pulling EN pin lower than 0.4V shuts down the RT9201 and reduces its quiescent current to 0.1 $\mu$ A.

Pulling EN pin higher than 1.4V enables the RT9201 and initiates the softstart cycle. A softstart capacitor connected to SS pin along with the internal 300k $\Omega$  resistor determines  $V_{REF}$  ramp-up speed and the softstart behavior. A softstart capacitor between 330pF to 1000pF is recommended for smooth start-up of RT9201.

### PWM Operation

During normal operation, the RT9201 regulates output voltage by switching at a constant frequency and then transferring the power to the load in each cycle by PWM. The RT9201 uses a slope-compensated, current-mode PWM controller capable of achieving 100% duty cycle. At each rising edge of the internal oscillator, the Control Logic cell sends a PWM ON signal to the Driver cell to turn on internal PMOSFET. This allows current to ramp up through the inductor to the load, and stores energy in a magnetic field. The switch remains on until either the current-limit is tripped or the PWM comparator signals for the output in regulation. After the switch is turned off, the inductor releases the magnetic energy and forces current through the NMOSFET synchronous rectifier to the output-filter capacitor and load. The output-filter capacitor stores charge when the inductor current is above the average output current and releases charge when the inductor current is below the average current to smooth the output voltage across the load.

A Zero Detector monitors inductor current by sensing

voltage drop across the NMOSFET synchronous rectifier when it turns on. The NMOSFET turns off and allows the converter entering discontinuous conduction mode when the inductor current decreases to zero. The zero current deflection on threshold is about 50mA. This reduces conduction loss and increase power conversion efficiency at light load condition.

### PSM Operation

The minimum on-time of RT9201 is approximately 200ns. Consequently, the converter will enter pulse-skipping-mode (PSM) during extreme light load condition or when modulation index ( $V_{OUT}/V_{IN}$ ) is extreme low. This could reduce switching loss and further increase power conversion efficiency.

For example :  $V_{IN} = 3.8V$ ,  $V_{OUT} = 2.5V$  &  $I_{LOAD} = 4mA$

### Low Dropout Mode Operation

The maximum on-time can exceed one oscillator cycle, which permits operation up to 100% duty cycle. As the input voltage drops, the duty cycle increases until the PMOSFET is held on continuously. Dropout voltage in 100% duty cycle is the output current multiplied by the on-resistance of the internal switch and inductor, around 300mV ( $I_{OUT} = 600mA$ ).

When the converter operates around the boundary of Low-Dropout-Mode and PWM, sub-harmonic oscillation and large ripple may occur at output voltage as shown in Figure 1. Figure 2 illustrates the boundary of stable PWM and Low-Dropout-Mode operations for typical output voltages. Above each boundary is the stable PWM mode region with respect to that output voltage. To prevent sub-harmonic oscillation, please make sure that  $V_{IN}$  and  $V_{OUT}$  locate in the stable PWM operation region. If the input voltage range must cross the boundary region, increasing output capacitors with low ESR can alleviate the output ripple voltage.

**Sub-Harmonic at Boundary Condition**

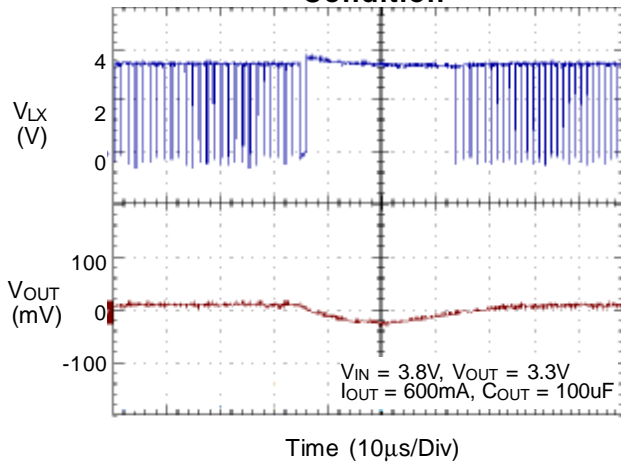

Figure 1

**Boundary of PWM and Low-Dropout Mode**

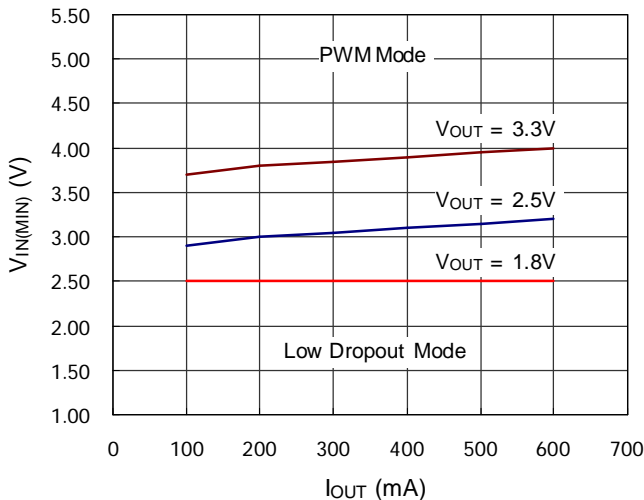

Figure 2

**Over Current Protection**

The RT9201 continuously monitors the inductor current by sensing the voltage across the PMOSFET when it turns on. When the inductor current is higher than current limit threshold (1A typical), OCP activates and forces the PMOSFET turning off to limit inductor current cycle by cycle.

The current limit is set to 50% level of normal condition when the output voltage is lower than its 50% normal level. This can minimize the power loss and protect the device when over current or output short circuit occurs. Once output voltage drops below to its 50% normal level

due to over current or short circuit, it can build up only when output current is lower 50% of normal current limit threshold.

**Output Voltage Setting and Feedback Network**

The output voltage can be set from  $V_{REF}$  to  $V_{IN}$  by a voltage divider as:

$$V_{OUT} = V_{REF} \times \frac{R_{F1} + R_{F2}}{R_{F2}}$$

The internal  $V_{REF}$  is 0.8V with 1% accuracy. In practical application, keep  $R_{F2} = 390k\Omega$  and  $C_{F2} = 10pF$  respectively and choose appropriate  $R_{F1}$  and  $C_{F1}$  according to the required output voltage. Make sure that the product of  $R_{F1}$  and  $C_{F1}$  is about 8200kΩ-pF. The following table shows recommended feedback network as well as inductor for some typical output voltages.

Table 1. Component Selection for Typical Application

$V_{OUT}$ (V)	$R_{F1}$ ( $\Omega$ )	$C_{F1}$ (pF)	$R_{F2}$ ( $\Omega$ )	$C_{F2}$ (pF)	$L_X$ ( $\mu H$ )	$C_{SS}$ (pF)
0.85	24k	330	390k	10	4.7	330
1.5	343k	22	390k	10	6.8	470
2.5	820k	10	390k	10	10	680
3.3	1.2M	5.6	390k	10	10	1000

**Inductor Selection**

The output inductor is suggested as the above table for optimal performance. Make sure that the inductor will not saturate over the operation conditions including temperature range, input voltage range, and maximum output current. If possible, choose an inductor with rated current higher than 1A so that it will not saturate even under circuit condition.

**Input Capacitor Selection**

The input capacitor can filter the input peak current and noise at input voltage source. The capacitor with low ESR (effective series resistance) provides the small drop voltage to stabilize the input voltage during the transient loading. For input capacitor selection, the ceramic capacitors larger than 10µF is recommend. The capacitor must conform to the RMS current requirement. The maximum RMS ripple current is calculated as :

$$I_{RMS} = I_{OUT(MAX)} \frac{\sqrt{V_{OUT}(V_{IN} - V_{OUT})}}{V_{IN}}$$

## Output Capacitor Selection

The capacitor's ESR determines the output ripple voltage and the initial voltage drop following a high slew-rate transient's edge. Typically, if the ESR requirement is satisfied, the capacitance is adequate to filtering. The output ripple voltage can be calculated as :

$$\Delta V_{OUT} = \Delta I_C \left( ESR + \frac{1}{8 \times C_{OUT} \times f_{OSC}} \right)$$

The ceramic capacitor with low ESR value provides the low output ripple and low size profile. Connect a 22μF ceramic capacitor at output terminal for good performance and place the input and output capacitors as close as possible to the device.

## Layout Considerations

Follow the PCB layout guidelines for optimal performance of RT9201.

1. For the main current paths as indicated in bold lines in Figure 3, keep their traces short and wide.
2. Put the input capacitor as close as possible to the device pins (PVDD and PGND).
3. LX node is with high frequency voltage swing and should be kept small area. Keep analog components away from LX node to prevent stray capacitive noise pick-up.
4. Connect feedback network behind the output capacitors. Keep the loop area small. Place the feedback components near the RT9201.
5. Connect all analog grounds to a command node and then connect the command node to the power ground behind the output capacitors.
6. An example of 2-layer PCB layout is shown in Figure 4 to Figure 6 for reference.

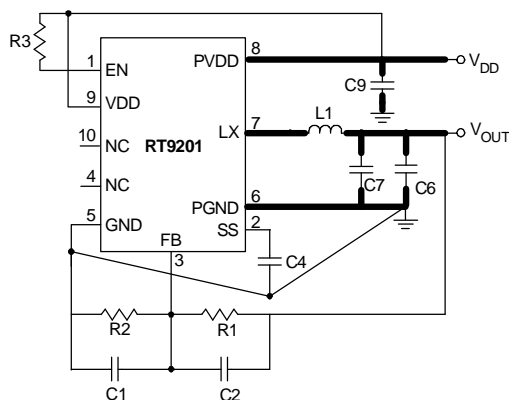

Figure 3. RT9201 Layout Diagram

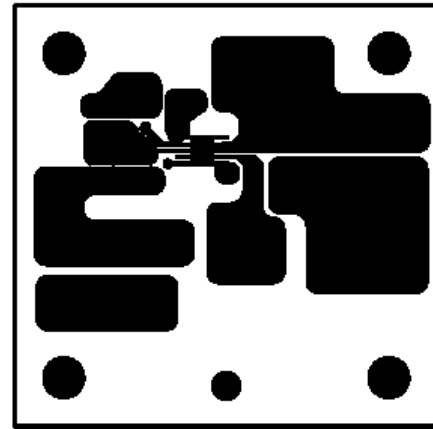

Figure 4. Top Layer

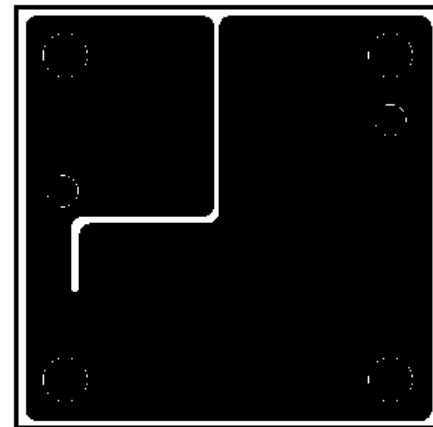

Figure 5. Bottom Layer

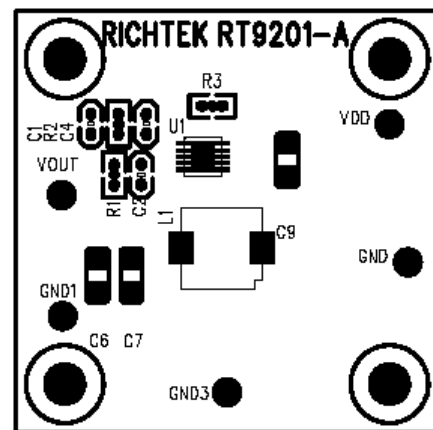
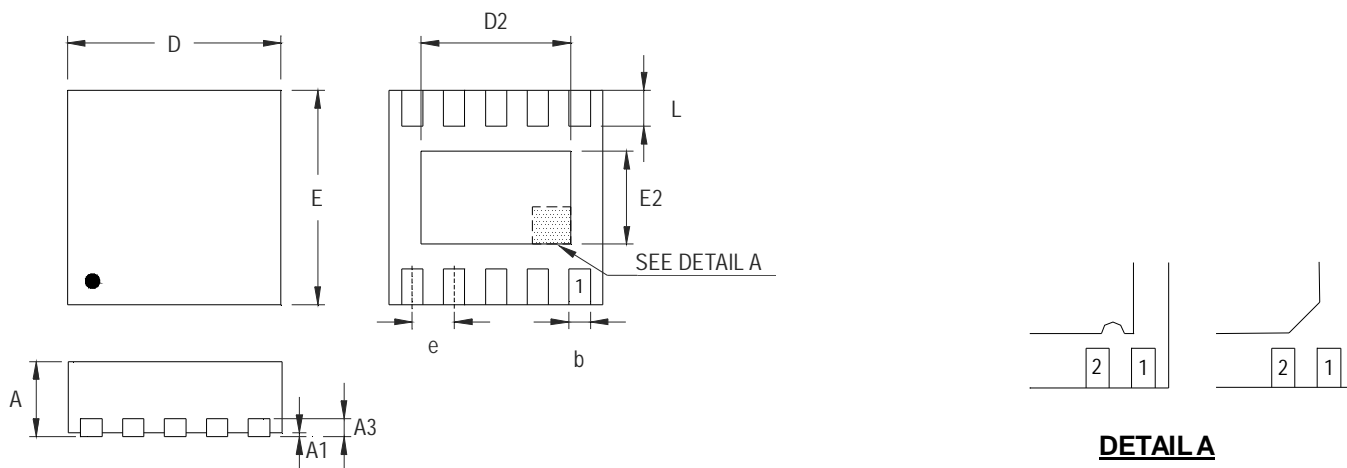

Figure 6. Silkscreen Layer

**Outline Dimension**



**DETAIL A**

Pin #1 ID and Tie Bar Mark Options

Note : The configuration of the Pin #1 identifier is optional, but must be located within the zone indicated.

Symbol	Dimensions In Millimeters		Dimensions In Inches	
	Min	Max	Min	Max
A	0.800	1.000	0.031	0.039
A1	0.000	0.050	0.000	0.002
A3	0.175	0.250	0.007	0.010
b	0.180	0.300	0.007	0.012
D	2.950	3.050	0.116	0.120
D2	2.300	2.650	0.091	0.104
E	2.950	3.050	0.116	0.120
E2	1.500	1.750	0.059	0.069
e	0.500		0.020	
L	0.350	0.450	0.014	0.018

**V-Type 10L DFN 3x3 Package**

**Richtek Technology Corporation**

Headquarter  
5F, No. 20, Taiyuen Street, Chupei City  
Hsinchu, Taiwan, R.O.C.  
Tel: (8863)5526789 Fax: (8863)5526611

**Richtek Technology Corporation**

Taipei Office (Marketing)  
8F, No. 137, Lane 235, Paochiao Road, Hsintien City  
Taipei County, Taiwan, R.O.C.  
Tel: (8862)89191466 Fax: (8862)89191465  
Email: marketing@richtek.com