

Power management (dual transistors)

UMF8N

2SC5585 and DTC144EE are housed independently in a UMT package.

●Application

Power management circuit

●Features

- 1) Power switching circuit in a single package.
- 2) Mounting cost and area can be cut in half.

●Structure

Silicon epitaxial planar transistor

●Equivalent circuits

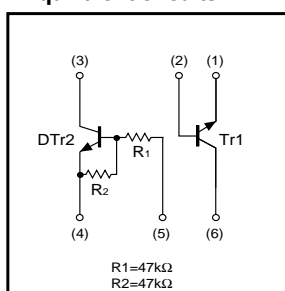

●External dimensions (Units : mm)

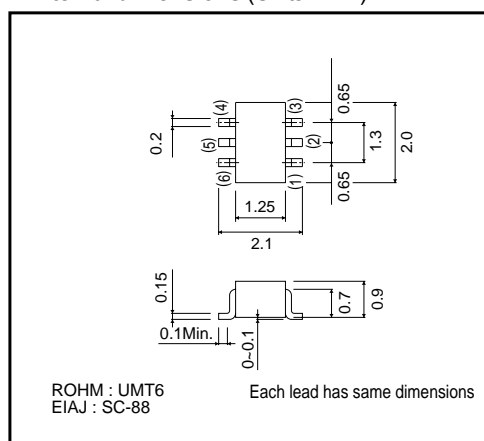

●Package, marking, and packaging specifications

Type	UMF8N
Package	UMT6
Marking	F8
Code	TR
Basic ordering unit (pieces)	3000

Transistors

●Absolute maximum ratings (Ta=25°C)

Tr1

Parameter	Symbol	Limits	Unit
Collector-base voltage	V _{CB0}	15	V
Collector-emitter voltage	V _{CEO}	12	V
Emitter-base voltage	V _{EBO}	6	V
Collector current	I _C	500	mA
	I _{CP}	1.0	A *1
Power dissipation	P _C	150(TOTAL)	mW *2
Junction temperature	T _J	150	°C
Range of storage temperature	T _{stg}	-55~+150	°C

*1 Single pulse P_w=1ms

*2 120mW per element must not be exceeded.

Each terminal mounted on a recommended land.

DTr2

Parameter	Symbol	Limits	Unit
Supply voltage	V _{CC}	50	V
Input voltage	V _{IN}	-10~+40	V
Collector current	I _C	100	mA *1
Output current	I _O	30	mA
Power dissipation	P _C	150(TOTAL)	mW *2
Junction temperature	T _J	150	°C
Range of storage temperature	T _{stg}	-55~+150	°C

*1 Characteristics of built-in transistor.

*2 120mW per element must not be exceeded.

Each terminal mounted on a recommended land.

●Electrical characteristics (Ta=25°C)

Tr1

Parameter	Symbol	Min.	Typ.	Max.	Unit	Conditions
Collector-emitter breakdown voltage	BV _{CEO}	12	–	–	V	I _C =1mA
Collector-base breakdown voltage	BV _{CB0}	15	–	–	V	I _C =10μA
Emitter-base breakdown voltage	BV _{EBO}	6	–	–	V	I _E =10μA
Collector cut-off current	I _{CB0}	–	–	100	nA	V _{CB} =15V
Emitter cut-off current	I _{EBO}	–	–	100	nA	V _{EB} =6V
Collector-emitter saturation voltage	V _{CE(sat)}	–	100	250	mV	I _C =200mA, I _B =10mA
DC current gain	h _{FE}	270	–	680	–	V _{CE} =2V, I _C =10mA
Transition frequency	f _T	–	320	–	MHz	V _{CE} =2V, I _E =-10mA, f=100MHz
Collector output capacitance	C _{ob}	–	7.5	–	pF	V _{CB} =10V, I _E =0mA, f=1MHz

DTr2

Parameter	Symbol	Min.	Typ.	Max.	Unit	Conditions
Input voltage	V _{I(off)}	–	–	0.5	V	V _{CC} =5V, I _O =100μA
	V _{I(on)}	3.0	–	–	V	V _O =0.3V, I _O =2mA
Output voltage	V _{O(on)}	–	100	300	mV	V _O =10mA, I _I =0.5mA
Input current	I _I	–	–	180	μA	V _I =5V
Output current	I _{O(off)}	–	–	500	nA	V _{CC} =50V, V _I =0V
DC current gain	G _I	68	–	–	–	V _O =5V, I _O =5mA
Transition frequency	f _T	–	250	–	MHz	V _{CE} =10V, I _E =5mA, f=100MHz *
Input resistance	R ₁	32.9	47	61.1	kΩ	–
Resistance ratio	R ₂ /R ₁	0.8	1.0	1.2	–	–

*Characteristics of built-in transistor.

Transistors

●Electrical characteristic curves

Tr1

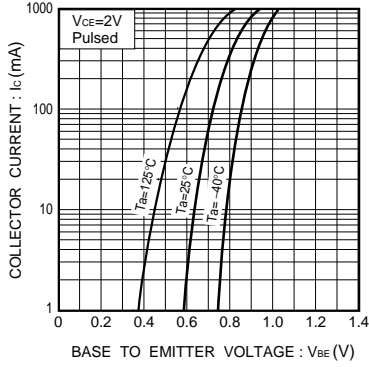

Fig.1 Grounded emitter propagation characteristics

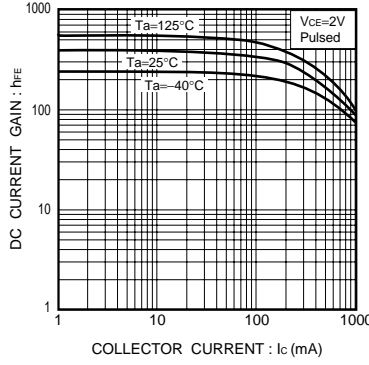

Fig.2 DC current gain vs. collector current

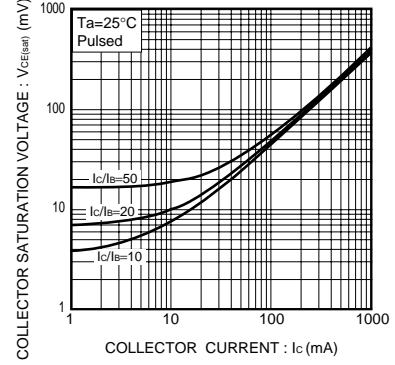

Fig.3 Collector-emitter saturation voltage vs. collector current (I)

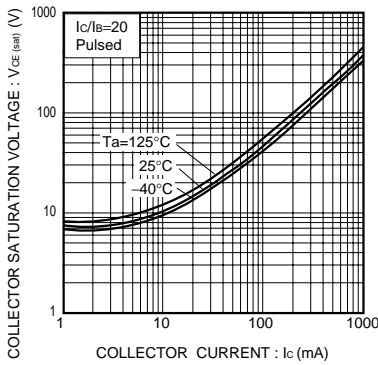

Fig.4 Collector-emitter saturation voltage vs. collector current (II)

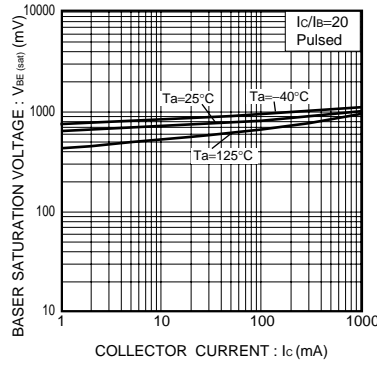

Fig.5 Base-emitter saturation voltage vs. collector current

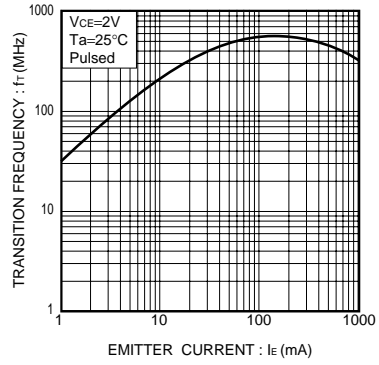

Fig.6 Gain bandwidth product vs. emitter current

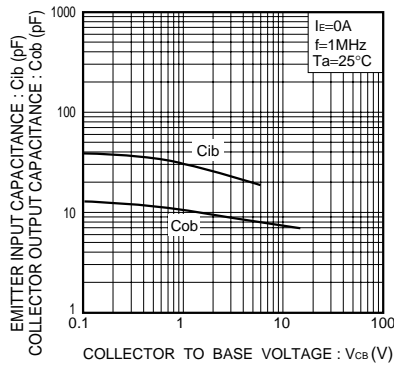

Fig.7 Collector output capacitance vs. collector-base voltage
Emitter input capacitance vs. emitter-base voltage

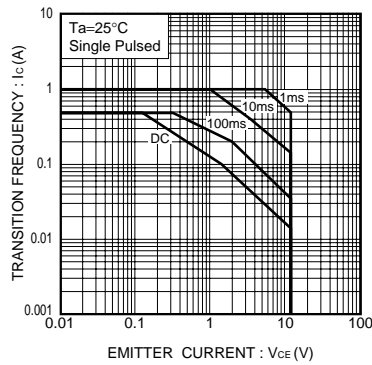

Fig.8 Safe operation area

Transistors

DTr2

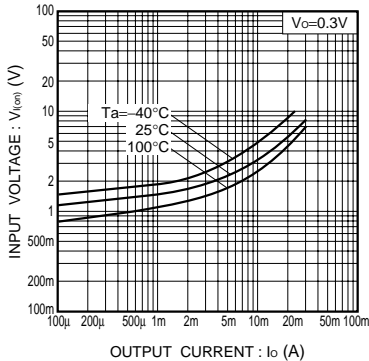

Fig.9 Input voltage vs. output current (ON characteristics)

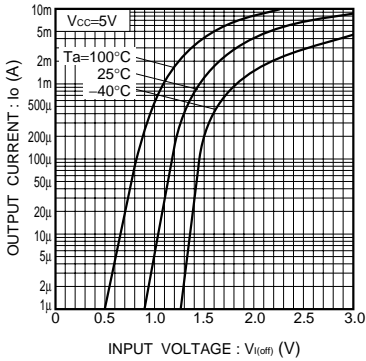

Fig.10 Output current vs. input voltage (OFF characteristics)

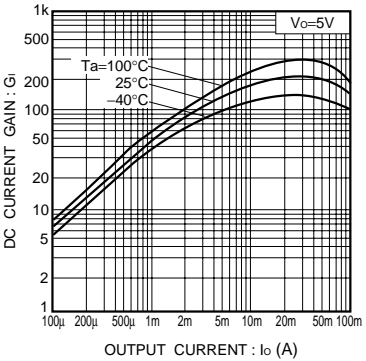

Fig.11 DC current gain vs. output current

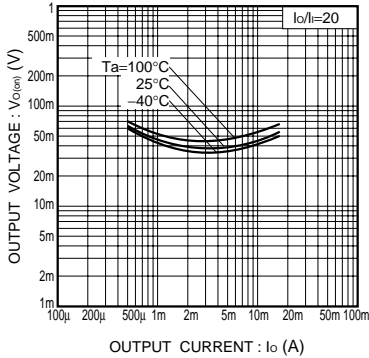

Fig.12 Output voltage vs. output current

Notes

- No technical content pages of this document may be reproduced in any form or transmitted by any means without prior permission of ROHM CO.,LTD.
- The contents described herein are subject to change without notice. The specifications for the product described in this document are for reference only. Upon actual use, therefore, please request that specifications to be separately delivered.
- Application circuit diagrams and circuit constants contained herein are shown as examples of standard use and operation. Please pay careful attention to the peripheral conditions when designing circuits and deciding upon circuit constants in the set.
- Any data, including, but not limited to application circuit diagrams information, described herein are intended only as illustrations of such devices and not as the specifications for such devices. ROHM CO.,LTD. disclaims any warranty that any use of such devices shall be free from infringement of any third party's intellectual property rights or other proprietary rights, and further, assumes no liability of whatsoever nature in the event of any such infringement, or arising from or connected with or related to the use of such devices.
- Upon the sale of any such devices, other than for buyer's right to use such devices itself, resell or otherwise dispose of the same, no express or implied right or license to practice or commercially exploit any intellectual property rights or other proprietary rights owned or controlled by
- ROHM CO., LTD. is granted to any such buyer.
- Products listed in this document use silicon as a basic material.
Products listed in this document are no antiradiation design.

The products listed in this document are designed to be used with ordinary electronic equipment or devices (such as audio visual equipment, office-automation equipment, communications devices, electrical appliances and electronic toys).

Should you intend to use these products with equipment or devices which require an extremely high level of reliability and the malfunction of which would directly endanger human life (such as medical instruments, transportation equipment, aerospace machinery, nuclear-reactor controllers, fuel controllers and other safety devices), please be sure to consult with our sales representative in advance.

About Export Control Order in Japan

Products described herein are the objects of controlled goods in Annex 1 (Item 16) of Export Trade Control Order in Japan.

In case of export from Japan, please confirm if it applies to "objective" criteria or an "informed" (by MITI clause) on the basis of "catch all controls for Non-Proliferation of Weapons of Mass Destruction.