

Features

- Diffused Junction
- Ultra-Fast Switching for High Efficiency
- High Current Capability and Low Forward Voltage Drop
- Surge Overload Rating to 60A Peak
- Low Reverse Leakage Current
- **Lead Free Finish, RoHS Compliant (Note 4)**

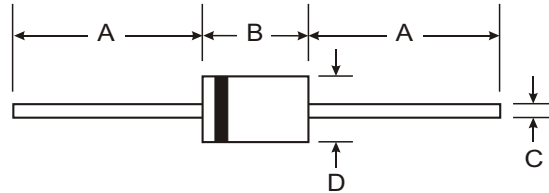

Mechanical Data

- Case: Molded Plastic
- Case Material: Molded Plastic. UL Flammability Classification Rating 94V-0
- Moisture Sensitivity: Level 1 per J-STD-020C
- Terminals: Finish – Bright Tin. Solderable per MIL-STD-202, Method 208
- Polarity: Cathode Band
- Marking: Type Number
- Mounting Position: Any
- Weight: 0.4 grams (approximate)

DO-15		
Dim	Min	Max
A	25.40	—
B	5.50	7.62
C	0.686	0.889
D	2.60	3.60
All Dimensions in mm		

Maximum Ratings and Electrical Characteristics @ T_A = 25°C unless otherwise specified

Single phase, half wave, 60Hz, resistive or inductive load.
For capacitive load, derate current by 20%.

Characteristic	Symbol	UF 2001	UF 2002	UF 2003	UF 2004	UF 2005	UF 2006	UF 2007	Unit
Peak Repetitive Reverse Voltage Working Peak Reverse Voltage DC Blocking Voltage	V _{RRM} V _{RWM} V _R	50	100	200	400	600	800	1000	V
RMS Reverse Voltage	V _{R(RMS)}	35	70	140	280	420	560	700	V
Average Rectified Output Current (Note 1) @ T _A = 50°C	I _O	2.0							A
Non-Repetitive Peak Forward Surge Current 8.3ms Single half sine-wave Superimposed on Rated Load (JEDEC Method)	I _{FSM}	60							A
Forward Voltage @ I _F = 2.0A	V _{FM}	1.0		1.3		1.7		V	
Peak Reverse Current @ T _A = 25°C at Rated DC Blocking Voltage @ T _A = 100°C	I _{RM}	5.0				100			μA
Reverse Recovery Time (Note 3)	t _{rr}	50				75			ns
Typical Junction Capacitance (Note 2)	C _j	50				30			pF
Typical Thermal Resistance Junction to Ambient	R _{θJA}	50							K/W
Operating and Storage Temperature Range	T _j , T _{STG}	-65 to +150							°C

- Notes:
1. Valid provided that leads are maintained at ambient temperature at a distance of 9.5mm from the case.
 2. Measured at 1.0MHz and applied reverse voltage of 4.0V DC.
 3. Measured at I_F = 0.5A, I_R = 1.0A, I_{rr} = 0.25A. See figure 5.
 4. RoHS revision 13.2.2003. Glass and High Temperature Solder Exemptions Applied, see EU Directive Annex Notes 5 and 7.

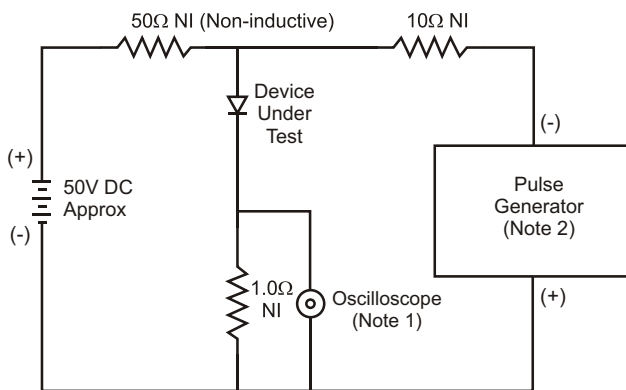
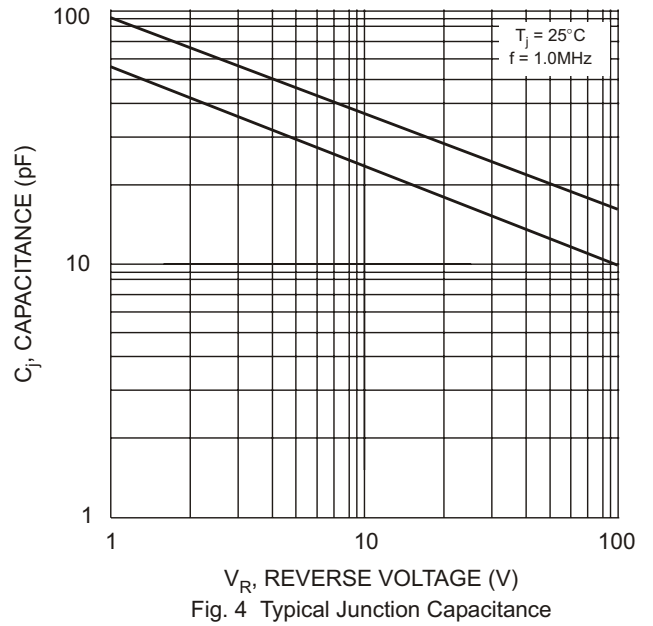
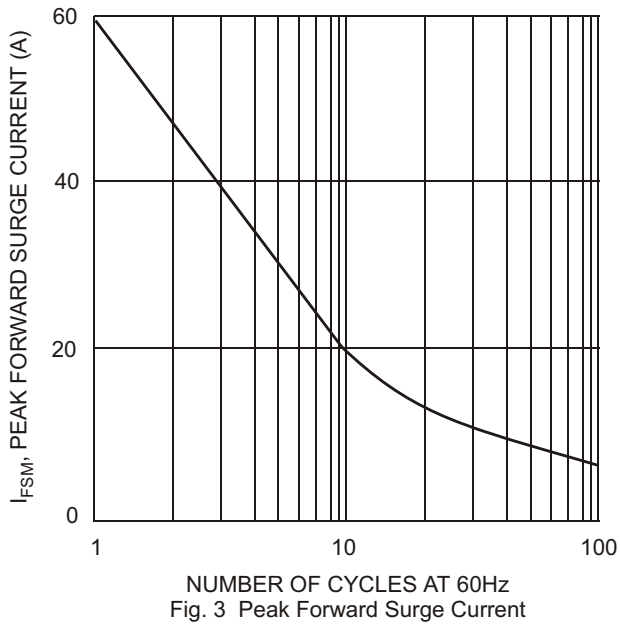
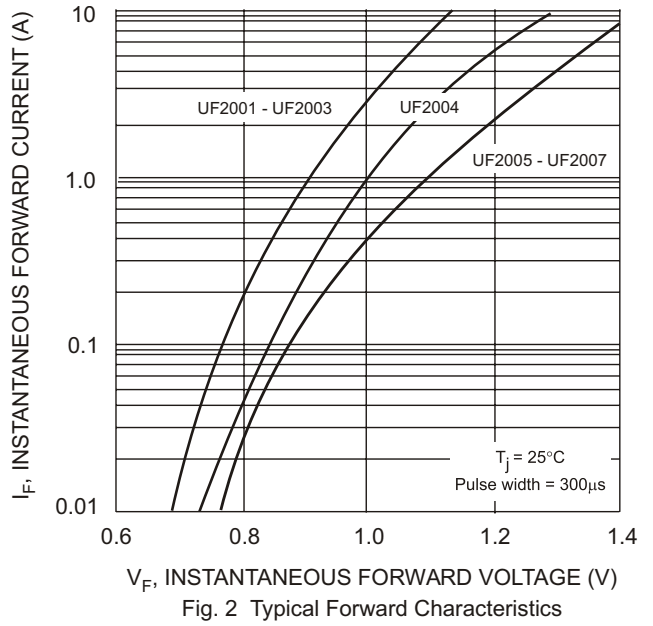
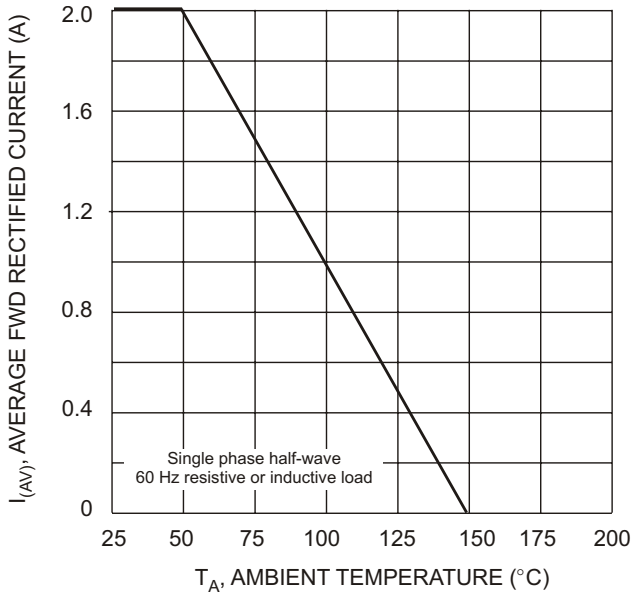

- Notes:
1. Rise Time = 7.0ns max. Input Impedance = 1.0MΩ, 22pF.
 2. Rise Time = 10ns max. Input Impedance = 50Ω.

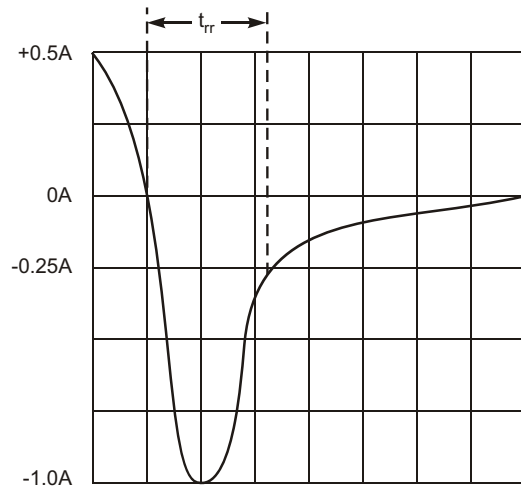

Set time base for 50/100 ns/cm

Fig. 5 Reverse Recovery Time Characteristic and Test Circuit

Ordering Information (Note 5)

Device	Packaging	Shipping
UF2001-T	DO-15	4K/Tape & Reel, 13-inch
UF2002-T	DO-15	4K/Tape & Reel, 13-inch
UF2003-T	DO-15	4K/Tape & Reel, 13-inch
UF2004-T	DO-15	4K/Tape & Reel, 13-inch
UF2005-T	DO-15	4K/Tape & Reel, 13-inch
UF2006-T	DO-15	4K/Tape & Reel, 13-inch
UF2007-T	DO-15	4K/Tape & Reel, 13-inch

Notes: 5. For Packaging Details, go to our website at <http://www.diodes.com/datasheets/ap02007.pdf>.