

# SMD Transient Voltage Suppressor



## TV15C5V0-G Thru TV15C171-G

Working Peak Reverse Voltage: 5.0 - 170 Volts  
 Power Dissipation: 1500 Watts  
 RoHS Device



### Features

- Ideal for surface mount applications
- Easy pick and place
- Plastic package has Underwriters Lab. flammability classification 94V-0
- Typical IR less than 1uA above 10V
- Fast reponse time: typically less 1nS for uni-direction, less than 5nS for bi-directiona, from 0 V to BV min.

### Mechanical data

- Case: JEDEC DO-214AB molded plastic
- Terminals: solderable per MIL-STD-750, method 2026
- Polarity: Cathode band denoted
- Approx. Weight:0.21 gram

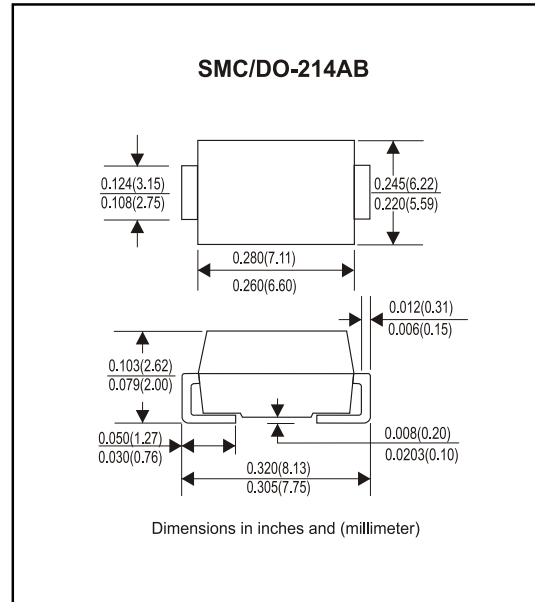

### Maximum Ratings and Electrical Characteristics

Rating at 25°C ambient temperature unless otherwise specified.  
 Single phase, half wave, 60Hz, resistive or inductive load.  
 For capacitive load, derate current by 20%

| Characteristics   | Symbol | Value       | Units |
|---|--------|-------------|-------|
| Peak Power Dissipation on 10/1000uS Waveform (Note 1, Fig. 1)   | PPPM   | 1500        | Watts |
| Peak Pulse Current of on 10/1000uS Waveform (Note 1, Fig. 3)  | IPPM   | See Table 1 | A     |
| Steady State Power Dissipation at TL=75°C (Note 2)  | PM(AV) | 5.0         | Watts |
| Peak Forfard Surge Current, 8.3mS Single Half Sine-Wave Superimposed on Rated Load, Uni-Directional Only (Note 3) | IFSM   | 200         | A     |
| Maxinum Instantaneous Forward Voltage at 100A for Uni-Directional only (Note 3 & 4)                               | VF     | 3.5/5.0     | Volts |
| Operation Junction Temperature Range  | Tj     | -55 to +150 | °C    |
| Storage Temperature Range   | TSTG   | -55 to +150 | °C    |

Note: 1. Non-Repetitive Current Pulse, per Fig. 3 and Derated above TA=25°C, per Fig. 2.  
 2. Mounted on 8.0x8.0 mm<sup>2</sup> Copper Pads to Each Terminal.  
 3. Measured on 8.3 mS Single Half Sine-Wave or Equivalent Square Wave, Duty Cycle=4 Pulse per Minute Maximum.  
 4. VF=3.5V on TV15C5V0 thru TV15C900 Devices and VF=5.0V on TV15C101 thru TV15C171.

## Rating and Characteristic Curves (TV15C5V0 Thru TV15C171)

Fig. 1 - Reverse Characteristics

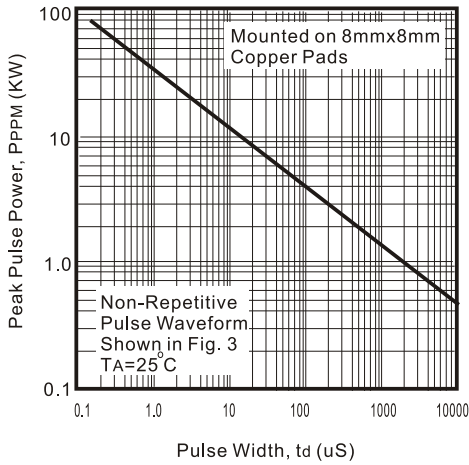

Fig. 2 - Pulse Derating Curve

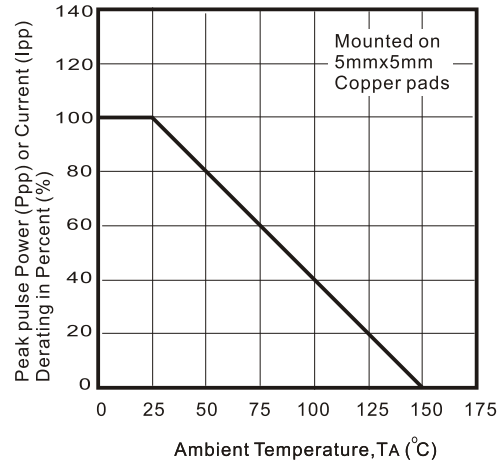

Fig. 3 - Pulse Waveform

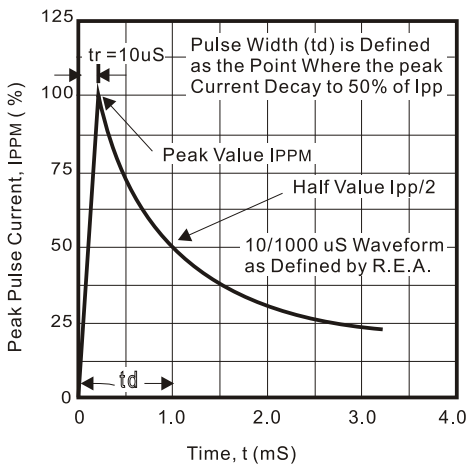

Fig. 4 - Typical Junction Capacitance for Uni-Directional Devices

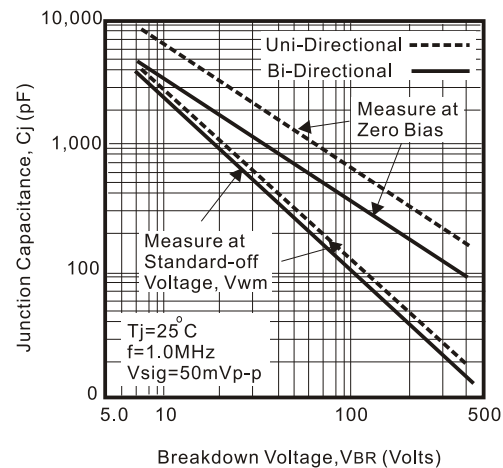

Fig. 5 - Steady State Power Derating Curve

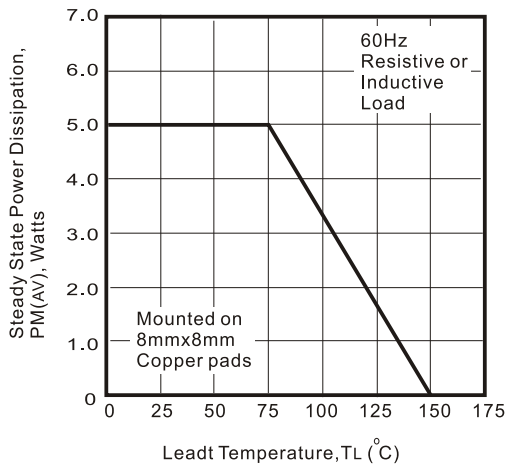
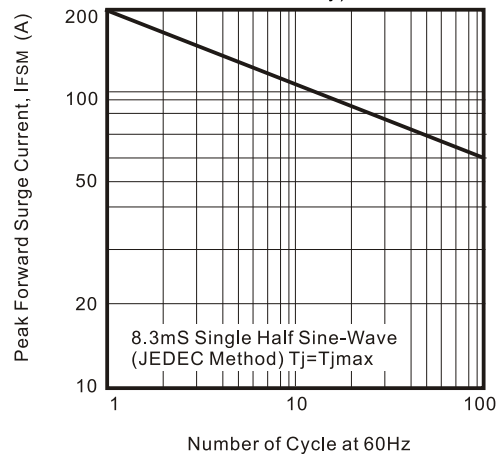

Fig. 6 - Maximum Non-Repetitive Peak Forward Surge Current (Uni-Directional Only)



# SMD Transient Voltage Suppressor



**Table 1. Specification**

| Part No        | Absolute Maximum Rating(T <sub>a</sub> =25°C) |                      |                      |                |                  | Electrical Characteristic(T <sub>a</sub> =25°C) |                     |                                  |               |     |
|----------------|---|----------------------|----------------------|----------------|------------------|---|---------------------|----------------------------------|---------------|-----|
|                | V <sub>RWM</sub>                              | V <sub>BR</sub> Min. | V <sub>BR</sub> Max. | I <sub>T</sub> | I <sub>FSM</sub> | Max V <sub>c</sub>                              | I <sub>PP</sub> (A) | I <sub>R</sub> @V <sub>RWM</sub> | Marking Code. |     |
|                | (V)   | (V)                  | (V)                  | (mA)           | (A)@8.3ms        | (V)   |                     | ( $\mu$ A)                       | UNI           | BI  |
| TV15C5V0K(B)-G | 5.00  | 6.40                 | 7.82                 | 10             | 200              | 9.6   | 156.2               | 800                              | GDD           | BDD |
| TV15C5V0J(B)-G | 5.00  | 6.40                 | 7.07                 | 10             | 200              | 9.2   | 163.0               | 800                              | GDE           | BDE |
| TV15C6V0K(B)-G | 6.00  | 6.67                 | 8.15                 | 10             | 200              | 11.4  | 131.6               | 800                              | GDF           | BDF |
| TV15C6V0J(B)-G | 6.00  | 6.67                 | 7.37                 | 10             | 200              | 10.3  | 145.6               | 800                              | GDG           | BDG |
| TV15C6V5K(B)-G | 6.50  | 7.22                 | 8.82                 | 10             | 200              | 12.3  | 122.0               | 500                              | GDH           | BDH |
| TV15C6V5J(B)-G | 6.50  | 7.22                 | 7.98                 | 10             | 200              | 11.2  | 133.9               | 500                              | GDK           | BDK |
| TV15C7V0K(B)-G | 7.00  | 7.78                 | 9.51                 | 1              | 200              | 13.3  | 112.8               | 200                              | GDL           | BDL |
| TV15C7V0J(B)-G | 7.00  | 7.78                 | 8.60                 | 1              | 200              | 12.0  | 125.0               | 200                              | GDM           | BDM |
| TV15C7V5K(B)-G | 7.50  | 8.33                 | 10.2                 | 1              | 200              | 14.3  | 104.9               | 100                              | GDN           | BDN |
| TV15C7V5J(B)-G | 7.50  | 8.33                 | 9.21                 | 1              | 200              | 12.9  | 116.3               | 100                              | GDP           | BDP |
| TV15C8V0K(B)-G | 8.00  | 8.89                 | 10.9                 | 1              | 200              | 15.0  | 100.0               | 50                               | GDQ           | BDQ |
| TV15C8V0J(B)-G | 8.00  | 8.89                 | 9.83                 | 1              | 200              | 13.6  | 110.3               | 50                               | GDR           | BDR |
| TV15C8V5K(B)-G | 8.55  | 9.44                 | 11.5                 | 1              | 200              | 15.9  | 94.3                | 10                               | GDS           | BDS |
| TV15C8V5J(B)-G | 8.55  | 9.44                 | 10.4                 | 1              | 200              | 14.4  | 104.2               | 10                               | GDT           | BDT |
| TV15C9V0K(B)-G | 9.00  | 10.0                 | 12.2                 | 1              | 200              | 16.9  | 88.7                | 5                                | GDU           | BDU |
| TV15C9V0J(B)-G | 9.00  | 10.0                 | 11.1                 | 1              | 200              | 15.4  | 97.4                | 5                                | GDV           | BDV |
| TV15C100K(B)-G | 10.0  | 11.1                 | 13.6                 | 1              | 200              | 18.8  | 79.8                | 5                                | GDW           | BDW |
| TV15C100J(B)-G | 10.0  | 11.1                 | 12.3                 | 1              | 200              | 17.0  | 88.2                | 5                                | GDX           | BDX |
| TV15C110K(B)-G | 11.0  | 12.2                 | 14.9                 | 1              | 200              | 20.1  | 74.6                | 5                                | GDY           | BDY |
| TV15C110J(B)-G | 11.0  | 12.2                 | 13.5                 | 1              | 200              | 18.2  | 82.4                | 5                                | GDZ           | BDZ |
| TV15C120K(B)-G | 12.0  | 13.3                 | 16.3                 | 1              | 200              | 22.0  | 68.2                | 5                                | GED           | BED |
| TV15C120J(B)-G | 12.0  | 13.3                 | 14.7                 | 1              | 200              | 19.9  | 75.3                | 5                                | GEE           | BEE |
| TV15C130K(B)-G | 13.0  | 14.4                 | 17.6                 | 1              | 200              | 23.8  | 63.0                | 5                                | GEF           | BEF |
| TV15C130J(B)-G | 13.0  | 14.4                 | 15.9                 | 1              | 200              | 21.5  | 69.7                | 5                                | GEG           | BEG |
| TV15C140K(B)-G | 14.0  | 15.6                 | 19.1                 | 1              | 200              | 25.8  | 58.1                | 5                                | GEH           | BEH |
| TV15C140J(B)-G | 14.0  | 15.6                 | 17.2                 | 1              | 200              | 23.2  | 64.7                | 5                                | GEK           | BEK |
| TV15C150K(B)-G | 15.0  | 16.7                 | 20.4                 | 1              | 200              | 26.9  | 55.8                | 5                                | GEL           | BEL |
| TV15C150J(B)-G | 15.0  | 16.7                 | 18.5                 | 1              | 200              | 24.4  | 61.5                | 5                                | GEM           | BEM |
| TV15C160K(B)-G | 16.0  | 17.8                 | 21.8                 | 1              | 200              | 28.8  | 52.1                | 5                                | GEN           | BEN |
| TV15C160J(B)-G | 16.0  | 17.8                 | 19.7                 | 1              | 200              | 26.0  | 57.7                | 5                                | GEP           | BEP |
| TV15C170K(B)-G | 17.0  | 18.9                 | 23.1                 | 1              | 200              | 30.5  | 49.2                | 5                                | GEQ           | BEQ |
| TV15C170J(B)-G | 17.0  | 18.9                 | 20.9                 | 1              | 200              | 27.6  | 53.3                | 5                                | GER           | BER |
| TV15C180K(B)-G | 18.0  | 20.0                 | 24.4                 | 1              | 200              | 32.2  | 46.6                | 5                                | GES           | BES |
| TV15C180J(B)-G | 18.0  | 20.0                 | 22.1                 | 1              | 200              | 29.2  | 51.4                | 5                                | GET           | BET |
| TV15C200K(B)-G | 20.0  | 22.2                 | 27.1                 | 1              | 200              | 35.8  | 41.9                | 5                                | GEU           | BEU |
| TV15C200J(B)-G | 20.0  | 22.2                 | 24.5                 | 1              | 200              | 32.4  | 46.3                | 5                                | GEV           | BEV |
| TV15C220K(B)-G | 22.0  | 24.4                 | 29.8                 | 1              | 200              | 39.4  | 38.1                | 5                                | GEW           | BEW |
| TV15C220J(B)-G | 22.0  | 24.4                 | 26.9                 | 1              | 200              | 35.5  | 42.2                | 5                                | GEX           | BEX |
| TV15C240K(B)-G | 24.0  | 26.7                 | 32.6                 | 1              | 200              | 43.0  | 34.9                | 5                                | GEY           | BEY |
| TV15C240J(B)-G | 24.0  | 26.7                 | 29.5                 | 1              | 200              | 38.9  | 38.6                | 5                                | GEZ           | BEZ |
| TV15C260K(B)-G | 26.0  | 28.9                 | 35.3                 | 1              | 200              | 46.6  | 32.2                | 5                                | GFD           | BFD |
| TV15C260J(B)-G | 26.0  | 28.9                 | 31.9                 | 1              | 200              | 42.1  | 35.6                | 5                                | GFE           | BFE |
| TV15C280K(B)-G | 28.0  | 31.1                 | 38.0                 | 1              | 200              | 50.0  | 30.0                | 5                                | GFF           | BFF |
| TV15C280J(B)-G | 28.0  | 31.1                 | 34.4                 | 1              | 200              | 45.4  | 33.0                | 5                                | GFG           | BFG |
| TV15C300K(B)-G | 30.0  | 33.3                 | 40.7                 | 1              | 200              | 53.5  | 28.0                | 5                                | GFH           | BFH |
| TV15C300J(B)-G | 30.0  | 33.3                 | 36.8                 | 1              | 200              | 48.4  | 31.0                | 5                                | GFK           | BFK |
| TV15C330K(B)-G | 33.0  | 36.7                 | 44.9                 | 1              | 200              | 59.0  | 25.2                | 5                                | GFL           | BFL |
| TV15C330J(B)-G | 33.0  | 36.7                 | 40.6                 | 1              | 200              | 53.3  | 28.1                | 5                                | GFM           | BFM |
| TV15C360K(B)-G | 36.0  | 40.0                 | 48.9                 | 1              | 200              | 64.3  | 23.3                | 5                                | GFN           | BFN |
| TV15C360J(B)-G | 36.0  | 40.0                 | 44.2                 | 1              | 200              | 58.1  | 25.8                | 5                                | GFP           | BFP |
| TV15C400K(B)-G | 40.0  | 44.4                 | 54.3                 | 1              | 200              | 71.4  | 21.0                | 5                                | GFQ           | BFQ |
| TV15C400J(B)-G | 40.0  | 44.4                 | 49.1                 | 1              | 200              | 64.5  | 23.2                | 5                                | GFR           | BFR |
| TV15C430K(B)-G | 43.0  | 47.8                 | 58.4                 | 1              | 200              | 76.7  | 19.6                | 5                                | GFS           | BFS |
| TV15C430J(B)-G | 43.0  | 47.8                 | 52.8                 | 1              | 200              | 69.4  | 21.6                | 5                                | GFT           | BFT |
| TV15C450K(B)-G | 45.0  | 50.0                 | 61.1                 | 1              | 200              | 80.3  | 18.7                | 5                                | GFU           | BFU |
| TV15C450J(B)-G | 45.0  | 50.0                 | 55.3                 | 1              | 200              | 72.7  | 20.6                | 5                                | GFV           | BFV |

Rev. A

# SMD Transient Voltage Suppressor



**Table 1. Specification**

| Part No        | Absolute Maximum Rating(Ta=25°C) |                      |                      |                |                  | Electrical Characteristic(Ta=25°C) |                     |                                  |               |     |
|----------------|----------------------------------|----------------------|----------------------|----------------|------------------|------------------------------------|---------------------|----------------------------------|---------------|-----|
|                | V <sub>RWM</sub>                 | V <sub>BR</sub> Min. | V <sub>BR</sub> Max. | I <sub>T</sub> | I <sub>FSM</sub> | Max V <sub>c</sub>                 | I <sub>PP</sub> (A) | I <sub>R</sub> @V <sub>RWM</sub> | Marking Code. |     |
|                | (V)                              | (V)                  | (V)                  | (mA)           | (A)@8.3ms        | (V)                                |                     | (uA)                             | UNI           | BI  |
| TV15C480K(B)-G | 48.0                             | 53.3                 | 65.1                 | 1              | 200              | 76.7                               | 17.5                | 5                                | GFW           | BFW |
| TV15C480J(B)-G | 48.0                             | 53.3                 | 58.9                 | 1              | 200              | 69.4                               | 21.6                | 5                                | GFX           | BFX |
| TV15C510K(B)-G | 51.0                             | 56.7                 | 69.3                 | 1              | 200              | 80.3                               | 18.7                | 5                                | GFY           | BFY |
| TV15C510J(B)-G | 51.0                             | 56.7                 | 62.7                 | 1              | 200              | 72.7                               | 20.6                | 5                                | GFZ           | BFZ |
| TV15C540K(B)-G | 54.0                             | 60.0                 | 73.3                 | 1              | 200              | 85.5                               | 15.6                | 5                                | GGD           | BGD |
| TV15C540J(B)-G | 54.0                             | 60.0                 | 66.3                 | 1              | 200              | 77.4                               | 17.2                | 5                                | GGE           | BGE |
| TV15C580K(B)-G | 58.0                             | 64.4                 | 78.7                 | 1              | 200              | 91.1                               | 14.6                | 5                                | GGF           | BGF |
| TV15C580J(B)-G | 58.0                             | 64.4                 | 71.2                 | 1              | 200              | 82.4                               | 16.0                | 5                                | GGG           | BGG |
| TV15C600K(B)-G | 60.0                             | 66.7                 | 81.5                 | 1              | 200              | 96.3                               | 14.0                | 5                                | GGH           | BGH |
| TV15C600J(B)-G | 60.0                             | 66.7                 | 73.7                 | 1              | 200              | 87.1                               | 15.5                | 5                                | GGK           | BGK |
| TV15C640K(B)-G | 64.0                             | 71.1                 | 86.9                 | 1              | 200              | 103.0                              | 13.2                | 5                                | GGL           | BGL |
| TV15C640J(B)-G | 64.0                             | 71.1                 | 78.6                 | 1              | 200              | 93.6                               | 14.6                | 5                                | GGM           | BGM |
| TV15C700K(B)-G | 70.0                             | 77.8                 | 95.1                 | 1              | 200              | 107.0                              | 12.0                | 5                                | GGN           | BGN |
| TV15C700J(B)-G | 70.0                             | 77.8                 | 86.0                 | 1              | 200              | 96.8                               | 13.3                | 5                                | GGP           | BGP |
| TV15C750K(B)-G | 75.0                             | 83.3                 | 102.0                | 1              | 200              | 114.0                              | 11.2                | 5                                | GGQ           | BGQ |
| TV15C750J(B)-G | 75.0                             | 83.3                 | 92.1                 | 1              | 200              | 103.0                              | 12.4                | 5                                | GGR           | BGR |
| TV15C780K(B)-G | 78.0                             | 86.7                 | 106.0                | 1              | 200              | 139.0                              | 10.8                | 5                                | GGS           | BGS |
| TV15C780J(B)-G | 78.0                             | 86.7                 | 95.8                 | 1              | 200              | 126.0                              | 11.4                | 5                                | GGT           | BGT |
| TV15C850K(B)-G | 85.0                             | 94.4                 | 115.0                | 1              | 200              | 151.0                              | 9.9                 | 5                                | GGU           | BGU |
| TV15C850J(B)-G | 85.0                             | 94.4                 | 104.0                | 1              | 200              | 137.0                              | 10.4                | 5                                | GGV           | BGV |
| TV15C900K(B)-G | 90.0                             | 100                  | 122.0                | 1              | 200              | 160.0                              | 9.4                 | 5                                | GGW           | BGW |
| TV15C900J(B)-G | 90.0                             | 100                  | 111.0                | 1              | 200              | 146.0                              | 10.3                | 5                                | GGX           | BGX |
| TV15C101K(B)-G | 100                              | 111                  | 136.0                | 1              | 200              | 179.0                              | 8.4                 | 5                                | GGY           | BGY |
| TV15C101J(B)-G | 100                              | 111                  | 123.0                | 1              | 200              | 162.0                              | 9.3                 | 5                                | GGZ           | BGZ |
| TV15C111K(B)-G | 110                              | 122                  | 149.0                | 1              | 200              | 196.0                              | 7.7                 | 5                                | GHD           | BHD |
| TV15C111J(B)-G | 110                              | 122                  | 135.0                | 1              | 200              | 177.0                              | 8.4                 | 5                                | GHE           | BHE |
| TV15C121K(B)-G | 120                              | 133                  | 163.0                | 1              | 200              | 214.0                              | 7.0                 | 5                                | GHF           | BHF |
| TV15C121J(B)-G | 120                              | 133                  | 147.0                | 1              | 200              | 193.0                              | 7.9                 | 5                                | GHG           | BHG |
| TV15C131K(B)-G | 130                              | 144                  | 176.0                | 1              | 200              | 231.0                              | 6.5                 | 5                                | GHH           | BHH |
| TV15C131J(B)-G | 130                              | 144                  | 159.0                | 1              | 200              | 209.0                              | 7.2                 | 5                                | GHK           | BHK |
| TV15C151K(B)-G | 150                              | 167                  | 204.0                | 1              | 200              | 268.0                              | 5.6                 | 5                                | GHL           | BHL |
| TV15C151J(B)-G | 150                              | 167                  | 185.0                | 1              | 200              | 243.0                              | 6.2                 | 5                                | GHM           | BHM |
| TV15C161K(B)-G | 160                              | 178                  | 218.0                | 1              | 200              | 287.0                              | 5.2                 | 5                                | GHN           | BHN |
| TV15C161J(B)-G | 160                              | 178                  | 197.0                | 1              | 200              | 259.0                              | 5.8                 | 5                                | GHP           | BHP |
| TV15C171K(B)-G | 170                              | 189                  | 231.0                | 1              | 200              | 304.0                              | 4.9                 | 5                                | GHQ           | BHQ |
| TV15C171J(B)-G | 170                              | 189                  | 209.0                | 1              | 200              | 275.0                              | 5.5                 | 5                                | GHR           | BHR |

Note:

- 1) Suffix K denotes 10% tolerance devices, suffix J denotes 5% tolerance devices.
- 2) Suffix B after part number to specify bi-directional devices.
- 3) For bi-directional devices having VR of 10 volts and under, the IR limit is double.