



TSM6968SD

20V Dual N-Channel MOSFET w/ESD Protected



Pin assignment:

1. Drain 1
2. Source 1
3. Source 1
4. Gate 1
5. Gate 2
6. Source 2
7. Source 2
8. Drain 2

$V_{DS} = 20V$

$R_{DS(on)}, V_{GS} @ 4.5V, I_{DS} @ 6.5A = 25m\Omega$

$R_{DS(on)}, V_{GS} @ 2.5V, I_{DS} @ 5.5A = 35m\Omega$

Features

- ◇ Advanced trench process technology
- ◇ High density cell design for ultra low on-resistance
- ◇ Excellent thermal and electrical capabilities
- ◇ Specially designed for Li-ion battery packs.
- ◇ Battery switch application

Ordering Information

Part No.	Packing	Package
TSM6968SDCA	Tape & Reel 3,000/per reel	TSSOP-8

Block Diagram

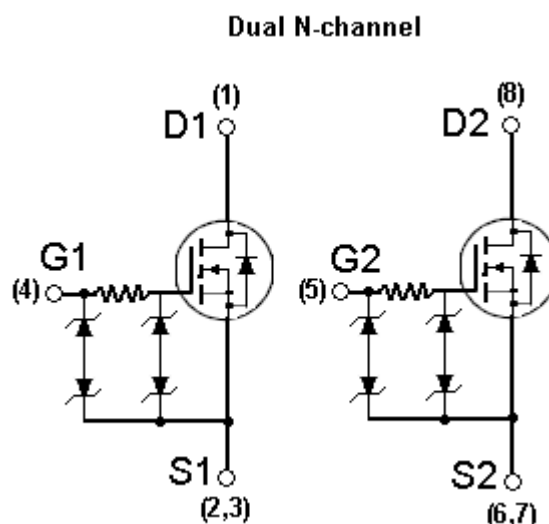

Absolute Maximum Rating ($T_a = 25^\circ C$ unless otherwise noted)

Parameter	Symbol	Limit	Unit	
Drain-Source Voltage	V_{DS}	20V	V	
Gate-Source Voltage	V_{GS}	± 12	V	
Continuous Drain Current, $V_{GS} @ 4.5V$.	I_D	6.5	A	
Pulsed Drain Current, $V_{GS} @ 4.5V$	I_{DM}	30	A	
Maximum Power Dissipation	P_D	$T_a = 25^\circ C$	1.5	W
		$T_a = 70^\circ C$	0.96	
Operating Junction Temperature	T_J	+150	$^\circ C$	
Operating Junction and Storage Temperature Range	T_J, T_{STG}	- 55 to +150	$^\circ C$	

Thermal Performance

Parameter	Symbol	Limit	Unit
Junction to Foot (Drain) Thermal Resistance	$R_{\theta JF}$	35	$^\circ C/W$
Junction to Ambient Thermal Resistance (PCB mounted)	$R_{\theta JA}$	83	$^\circ C/W$

Note: Surface mounted on FR4 board $t \leq 10sec$.

Electrical Characteristics						
Rate $I_D = 6.5A$, ($T_a = 25^\circ C$ unless otherwise noted)						
Parameter	Conditions	Symbol	Min	Typ	Max	Unit
Static						
Drain-Source Breakdown Voltage	$V_{GS} = 0V, I_D = 250\mu A$	BV_{DSS}	20	--	--	V
Drain-Source On-State Resistance	$V_{GS} = 4.5V, I_D = 6.5A$	$R_{DS(ON)}$	--	18	25	m Ω
Drain-Source On-State Resistance	$V_{GS} = 2.5V, I_D = 5.5A$	$R_{DS(ON)}$	--	28	35	
Gate Threshold Voltage	$V_{DS} = V_{GS}, I_D = 250\mu A$	$V_{GS(TH)}$	0.5	0.85	--	V
Zero Gate Voltage Drain Current	$V_{DS} = 20V, V_{GS} = 0V$	I_{DSS}	--	--	1.0	μA
Gate Body Leakage	$V_{GS} = \pm 12V, V_{DS} = 0V$	I_{GSS}	--	--	± 10	μA
On-State Drain Current	$V_{GS} = 4.5V, V_{DS} \geq 5V$	$I_{D(ON)}$	30	--	--	A
Forward Transconductance	$V_{DS} = 10V, I_D = 6.5A$	g_{fs}	--	30	--	S
Dynamic						
Total Gate Charge	$V_{DS} = 10V, I_D = 6.5A,$ $V_{GS} = 4.5V$	Q_g	--	15.5	30	nC
Gate-Source Charge		Q_{gs}	--	2	--	
Gate-Drain Charge		Q_{gd}	--	3.5	--	
Turn-On Delay Time	$V_{DD} = 10V, R_L = 10\Omega,$ $I_D = 1A, V_{GEN} = 4.5V,$ $R_G = 6\Omega$	$t_{d(on)}$	--	75	100	nS
Turn-On Rise Time		t_r	--	125	150	
Turn-Off Delay Time		$t_{d(off)}$	--	600	720	
Turn-Off Fall Time		t_f	--	300	360	
Input Capacitance	$V_{DS} = 10V, V_{GS} = 0V,$ $f = 1.0MHz$	C_{iss}	--	1336	--	pF
Output Capacitance		C_{oss}	--	220	--	
Reverse Transfer Capacitance		C_{rss}	--	130	--	
Source-Drain Diode						
Max. Diode Forward Current		I_S	--	--	1.5	A
Diode Forward Voltage	$I_S = 1.5A, V_{GS} = 0V$	V_{SD}	--	0.6	1.2	V

Note : pulse test: pulse width $\leq 300\mu s$, duty cycle $\leq 2\%$

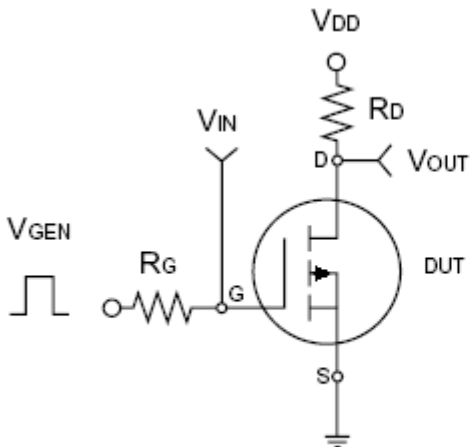

Switching Test Circuit

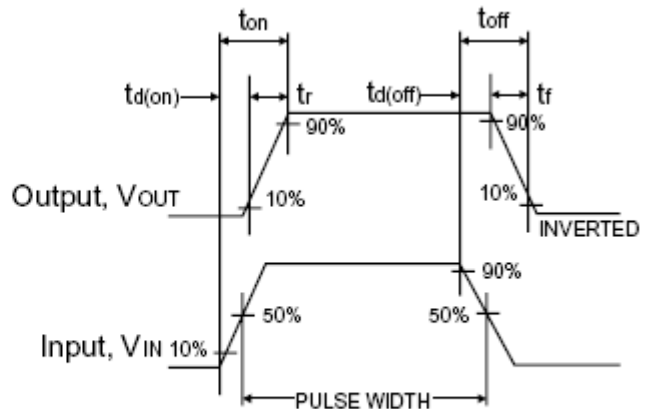

Switchin Waveforms



Typical Characteristics Curve ($T_a = 25^\circ\text{C}$ unless otherwise noted)

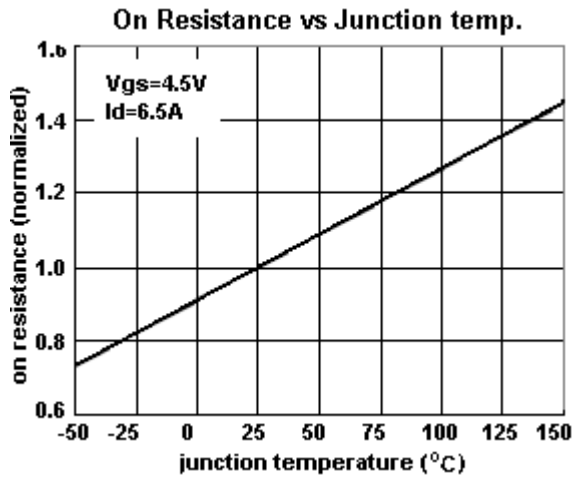
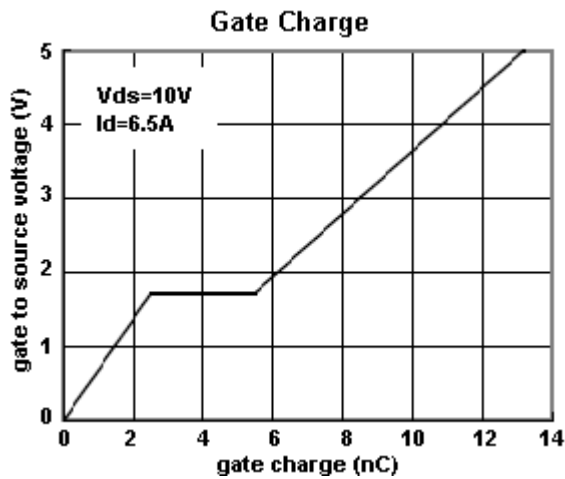
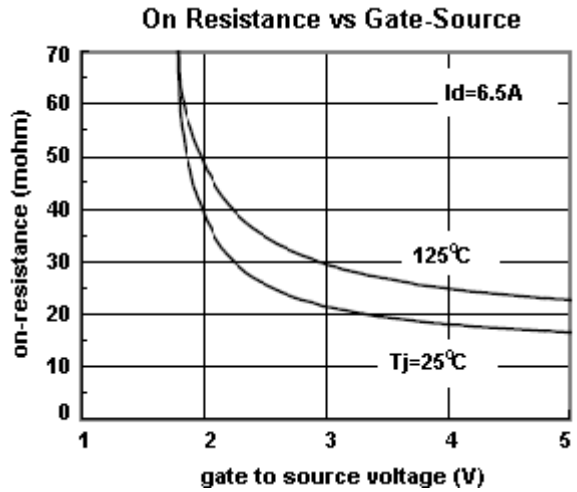
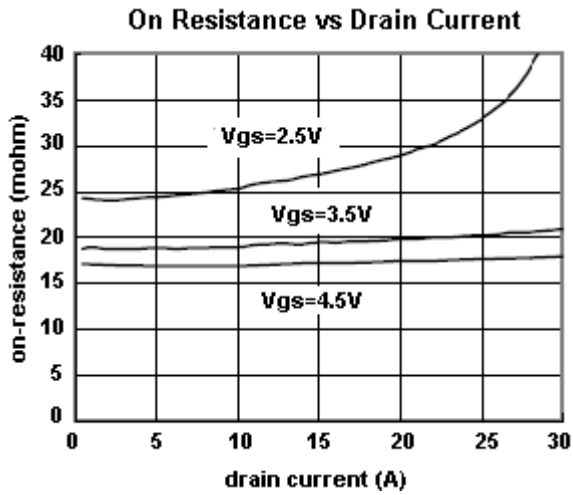
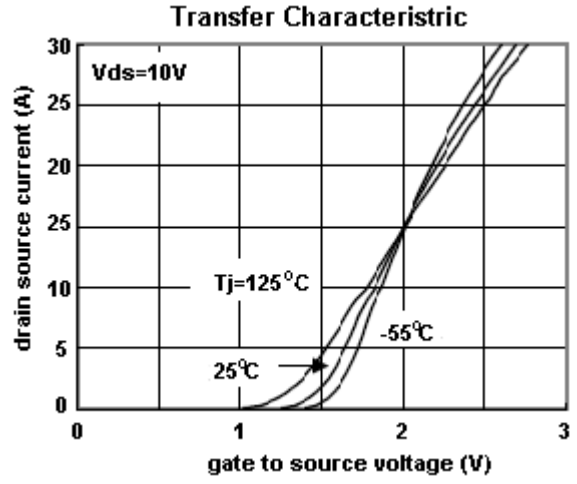
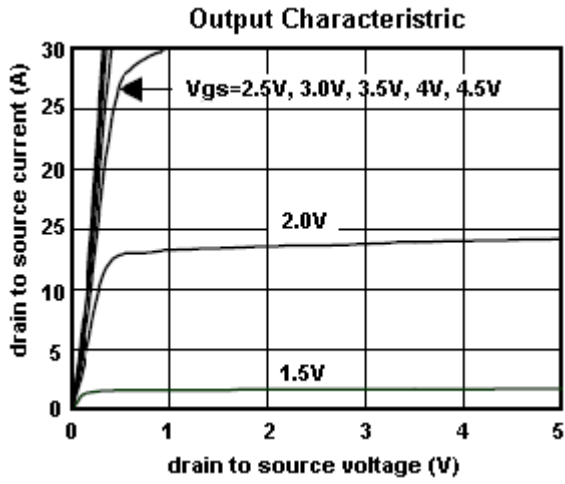

Electrical Characteristics Curve (continued)

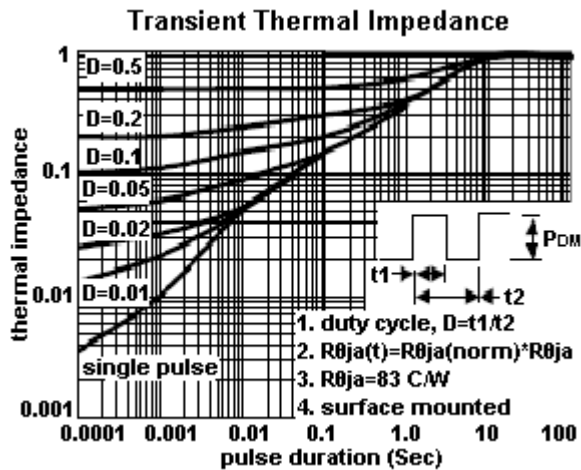
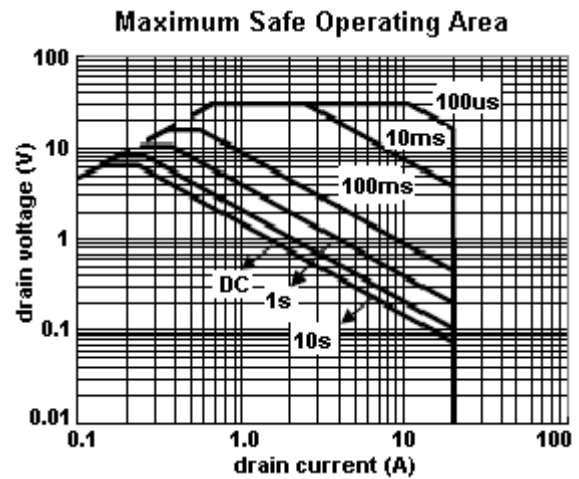
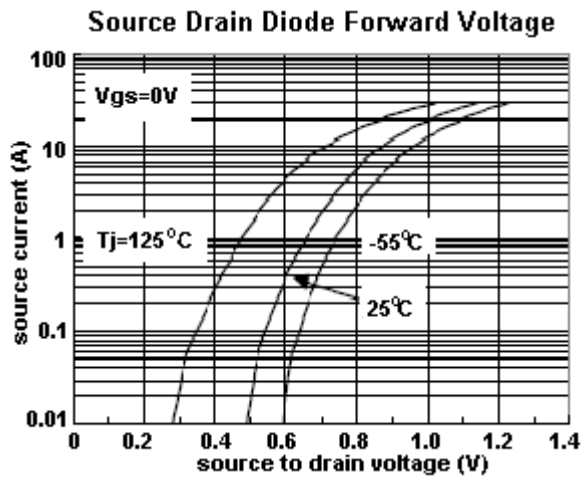
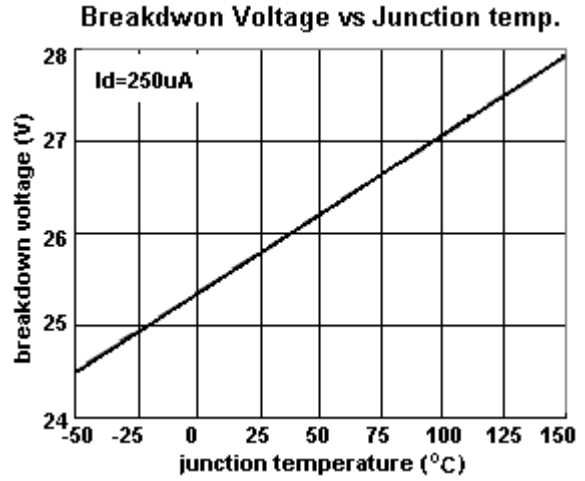
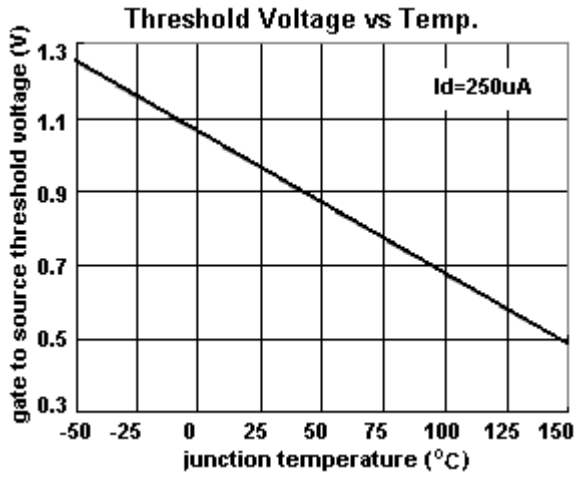

TSSOP-8 Mechanical Drawing

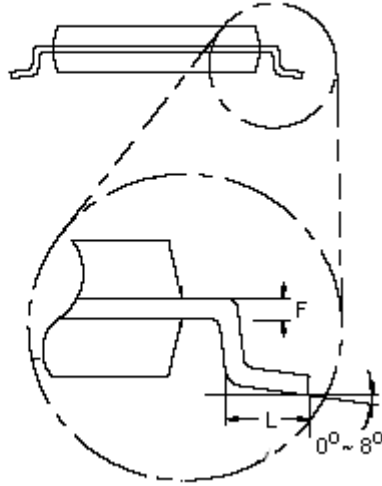
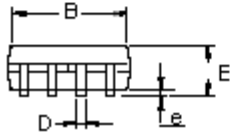
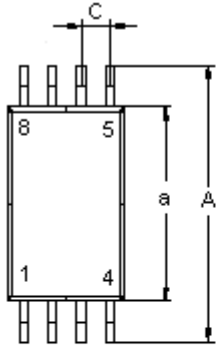

TSSOP-8 DIMENSION				
DIM	MILLIMETERS		INCHES	
	MIN	MAX	MIN	MAX
A	6.20	6.60	0.244	0.260
a	4.30	4.50	0.170	0.177
B	2.90	3.10	0.114	0.122
C	0.65 (typ)		0.025 (typ)	
D	0.25	0.30	0.010	0.019
E	1.05	1.20	0.041	0.049
e	0.05	0.15	0.002	0.009
F	0.127		0.005	
L	0.50	0.70	0.020	0.028