

APPLICATIONS

- Rectification
- Freewheel Diode
- DC Motor Control
- Power Supplies
- Welding
- Battery Chargers

KEY PARAMETERS

V_{RRM}	3600V
$I_{F(AV)}$	2530A
I_{FSM}	27000A

FEATURES

- Double Side Cooling
- High Surge Capability

VOLTAGE RATINGS

Type Number	Repetitive Peak Reverse Voltage V_{RRM} V	Conditions
TRB64 36	3600	$V_{RSM} = V_{RRM} + 100V$
TRB64 34	3400	
TRB64 32	3200	
TRB64 30	3000	
TRB64 28	2800	
TRB64 26	2600	

Lower voltage grades available.

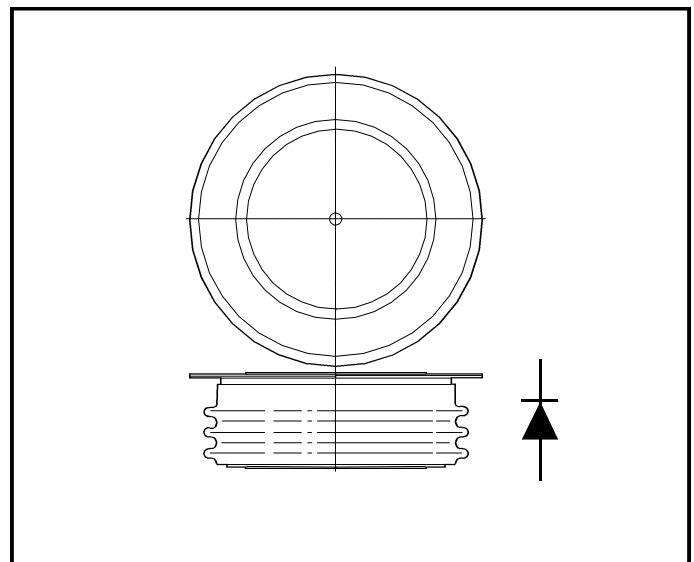

Outline type code: DO200AD.
See Package Details for further information.

CURRENT RATINGS

Symbol	Parameter	Conditions	Max.	Units
Double Side Cooled				
$I_{F(AV)}$	Mean forward current	Half wave resistive load, $T_{case} = 100^{\circ}C$	2530	A
$I_{F(RMS)}$	RMS value	$T_{case} = 100^{\circ}C$	3980	A
I_F	Continuous (direct) forward current	$T_{case} = 100^{\circ}C$	3635	A
Single Side Cooled (Anode side)				
$I_{F(AV)}$	Mean forward current	Half wave resistive load, $T_{case} = 100^{\circ}C$	1655	A
$I_{F(RMS)}$	RMS value	$T_{case} = 100^{\circ}C$	2600	A
I_F	Continuous (direct) forward current	$T_{case} = 100^{\circ}C$	2280	A

TRB64

SURGE RATINGS

Symbol	Parameter	Conditions	Max.	Units
I_{FSM}	Surge (non-repetitive) forward current	10ms half sine; $T_{case} = 175^{\circ}C$ $V_R = 50\% V_{RRM} - 1/4$ sine	21.5	kA
I^2t	I^2t for fusing		2.33×10^6	A ² s
I_{FSM}	Surge (non-repetitive) forward current	10ms half sine; $T_{case} = 175^{\circ}C$ $V_R = 0$	27.0	kA
I^2t	I^2t for fusing		3.645×10^6	A ² s

THERMAL AND MECHANICAL DATA

Symbol	Parameter	Conditions	Min.	Max.	Units	
$R_{th(j-c)}$	Thermal resistance - junction to case	Double side cooled	dc	-	0.013	$^{\circ}C/W$
		Single side cooled	Anode dc	-	0.025	$^{\circ}C/W$
			Cathode dc	-	0.027	$^{\circ}C/W$
$R_{th(c-h)}$	Thermal resistance - case to heatsink	Clamping force 44.0kN with mounting compound	Double side	-	0.003	$^{\circ}C/W$
			Single side	-	0.006	$^{\circ}C/W$
T_{vj}	Virtual junction temperature	Forward (conducting)		-	185	$^{\circ}C$
		Reverse (blocking)		-	175	$^{\circ}C$
T_{stg}	Storage temperature range			-55	200	$^{\circ}C$
-	Clamping force			40.0	48.0	kN

CHARACTERISTICS

Symbol	Parameter	Conditions	Typ.	Max.	Units
V_{FM}	Forward voltage	At 1500A peak, $T_{case} = 25^{\circ}C$	-	1.1	V
I_{RRM}	Peak reverse current	At V_{RRM} , $T_{case} = 175^{\circ}C$	-	100	mA
Q_S	Total stored charge	$I_F = 1000A$, $dI_{RR}/dt = 5A/\mu s$ $T_{case} = 125C$, $V_R = 100V$	4000	-	μC
I_{RR}	Peak recovery current		150	-	A
t_{rr}	Reverse recovery time		30	-	μs
V_{TO}	Threshold voltage	At $T_{vj} = 175C$	-	0.86	V
r_T	Slope resistance	At $T_{vj} = 175C$	-	0.2	m Ω

CURVES

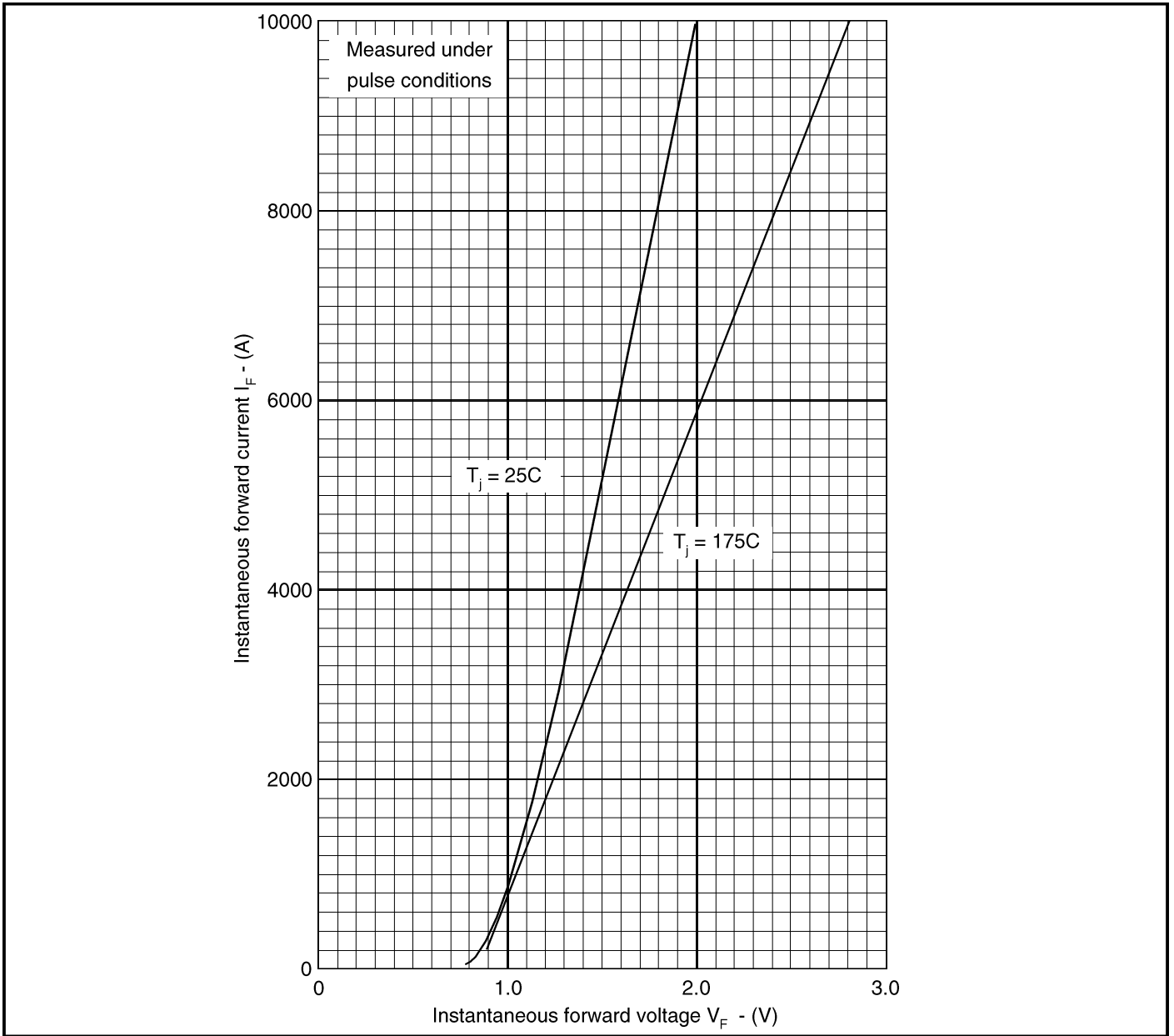

Fig.1 Maximum (limit) forward characteristics

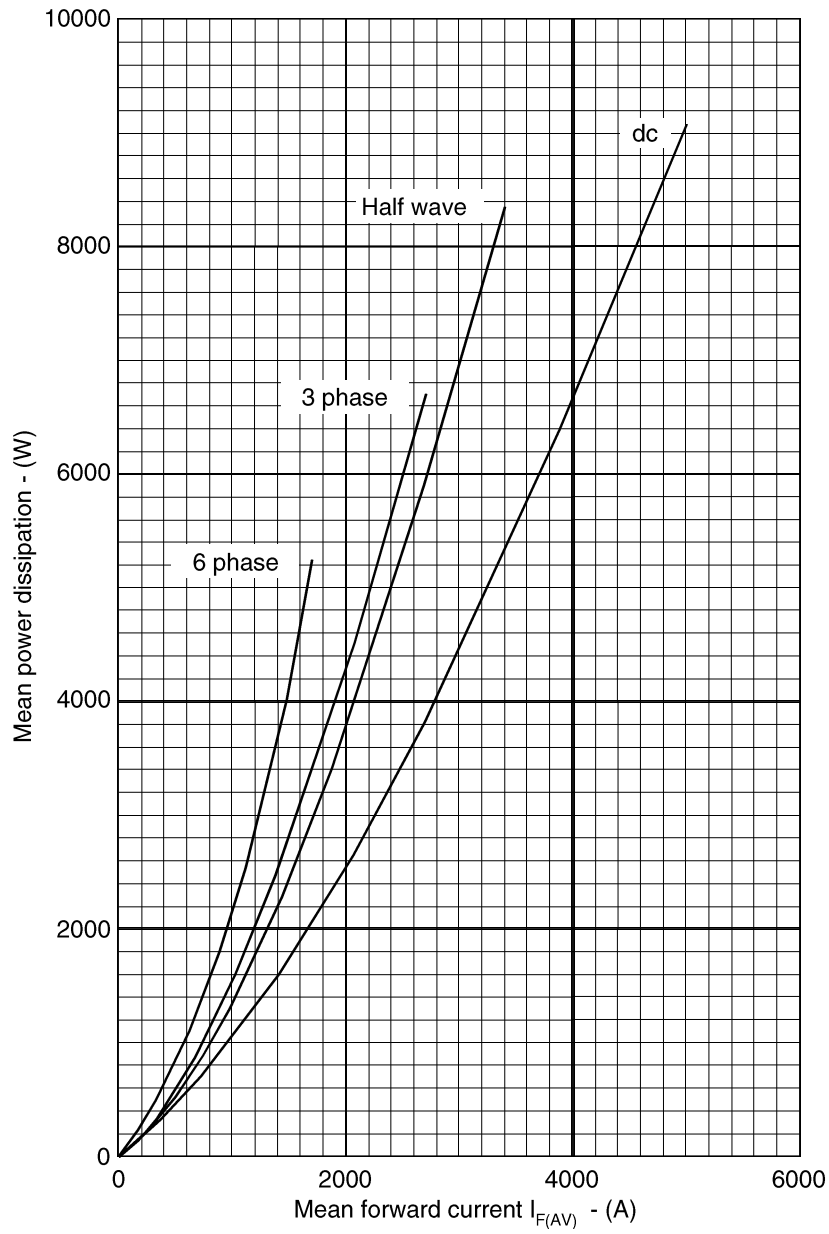

Fig.2 Dissipation curves

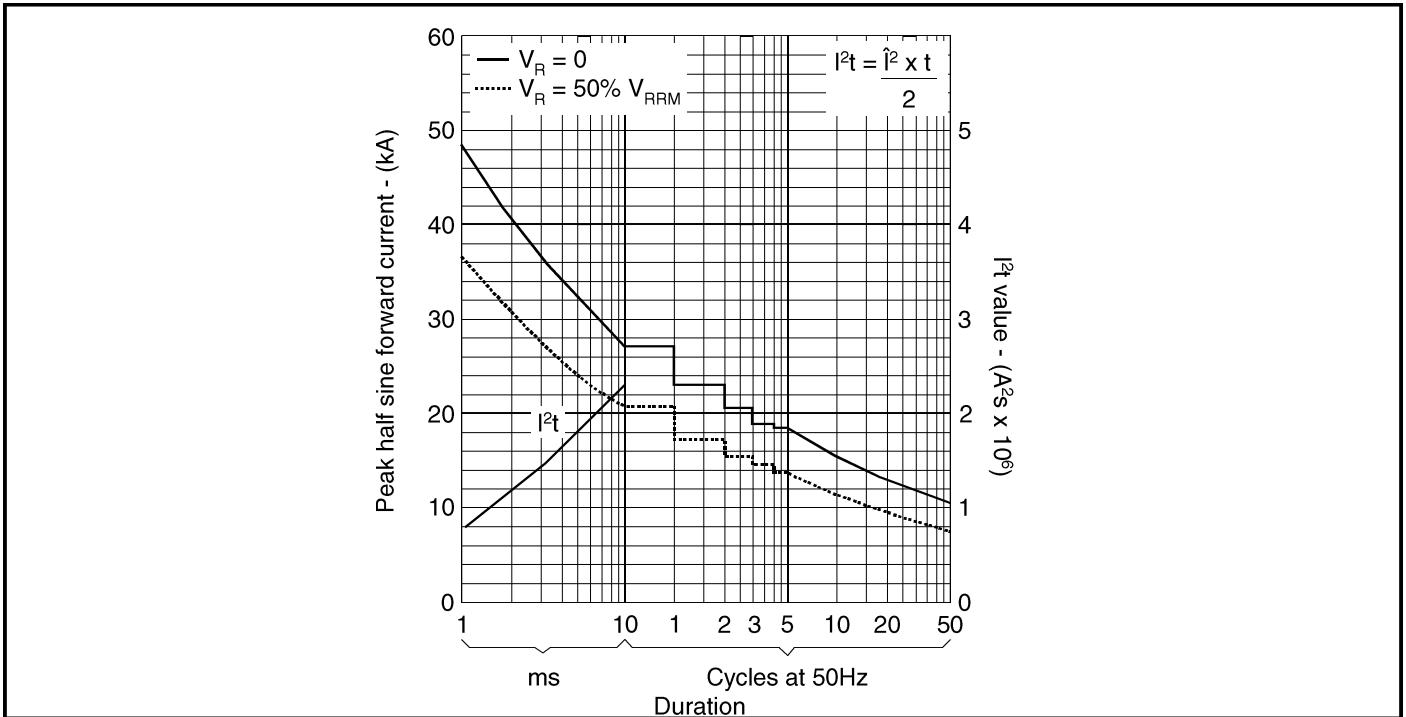

Fig.3 Surge (non-repetitive) forward current vs time ($T_{case} = 175C$)

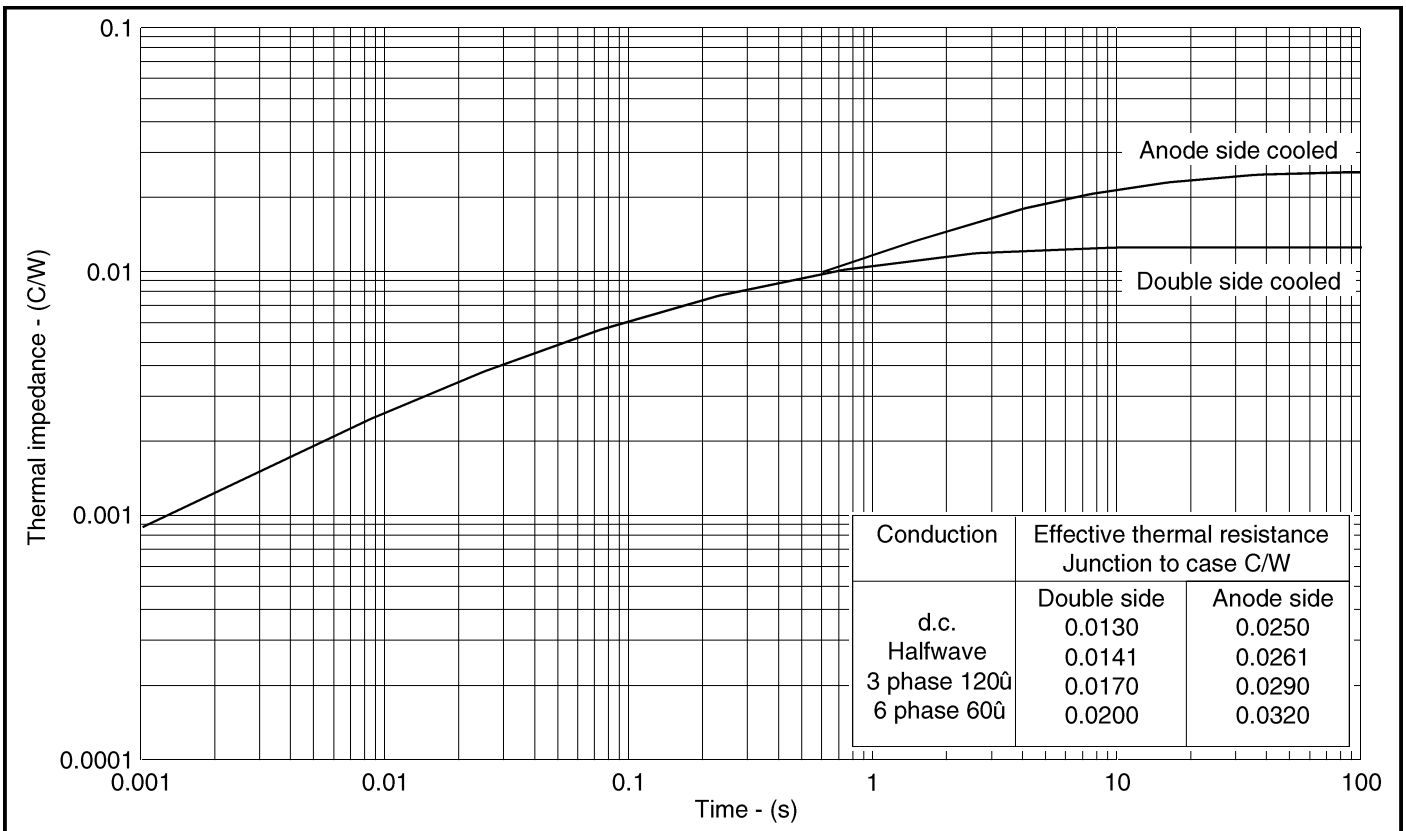

Fig.4 Maximum (limit) transient thermal impedance - junction to case - (C/W)

