

## TELUX™ LED

### Description

The TELUX™ series is a clear, non diffused LED for high end applications where supreme luminous flux is required.

It is designed in an industry standard 7.62 mm square package utilizing highly developed InGaN technology. The supreme heat dissipation of TELUX™ allows applications at high ambient temperatures.

All packing units are binned for luminous flux and color to achieve best homogenous light appearance in application.

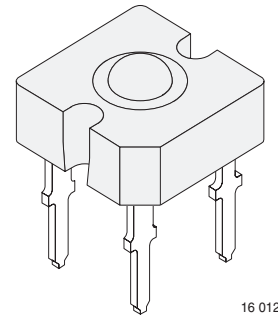

16 012

### Features

- Utilizing InGaN technology
- High luminous flux
- Supreme heat dissipation:  $R_{thJP}$  is 90 K/W
- High operating temperature:  $T_j + 100\text{ °C}$
- Packed in tubes for automatic insertion
- Luminous flux and color categorized for each tube
- Small mechanical tolerances allow precise usage of external reflectors or lightguides

- ESD-withstand voltage:  
> 1 kV acc. to MIL STD 883 D, Method 3015.7

### Applications

- Exterior lighting
- Interior lighting
- Dashboard illumination
- Replaces incandescent lamps

### Parts Table

Part	Color, Luminous Intensity	Angle of Half Intensity ( $\pm\phi$ )	Technology
TLWW9900	White, $\phi_V > 800\text{ mlm}$	45	InGaN / YAG on SiC

### Absolute Maximum Ratings

$T_{amb} = 25\text{ °C}$ , unless otherwise specified

#### TLWW9900

Parameter	Test condition	Symbol	Value	Unit
Reverse voltage	$I_R = 10\ \mu\text{A}$	$V_R$	5	V
DC forward current	$T_{amb} \leq 50\text{ °C}$	$I_F$	50	mA
Surge forward current	$t_p \leq 10\ \mu\text{s}$	$I_{FSM}$	0.1	A
Power dissipation	$T_{amb} \leq 50\text{ °C}$	$P_V$	255	mW
Junction temperature		$T_j$	100	°C
Operating temperature range		$T_{amb}$	- 40 to + 100	°C
Storage temperature range		$T_{stg}$	- 55 to + 100	°C
Soldering temperature	$t \leq 5\text{ s}$ , 1.5 mm from body preheat temperature 100 °C/ 30 sec.	$T_{sd}$	260	°C
Thermal resistance junction/ ambient	with cathode heatsink of 70 mm <sup>2</sup>	$R_{thJA}$	200	K/W
Thermal resistance junction/pin		$R_{thJP}$	90	K/W



## Optical and Electrical Characteristics

T<sub>amb</sub> = 25 °C, unless otherwise specified

### White

#### TLWW9900

Parameter	Test condition	Symbol	Min	Typ.	Max	Unit
Total flux	I <sub>F</sub> = 50 mA, R <sub>thJA</sub> = 200 °K/W	φ <sub>V</sub>	800	1500		mlm
Luminous intensity/Total flux	I <sub>F</sub> = 50 mA, R <sub>thJA</sub> = 200 °K/W	I <sub>V</sub> /φ <sub>V</sub>		0.8		mcd/mlm
Color temperature	I <sub>F</sub> = 50 mA, R <sub>thJA</sub> = 200 °K/W	T <sub>K</sub>		5500		K
Angle of half intensity	I <sub>F</sub> = 50 mA, R <sub>thJA</sub> = 200 °K/W	φ		± 45		deg
Total included angle	90 % of Total Flux Captured	φ		75		deg
Forward voltage	I <sub>F</sub> = 50 mA, R <sub>thJA</sub> = 200 °K/W	V <sub>F</sub>		4.3	5.2	V
Reverse voltage	I <sub>R</sub> = 10 μA	V <sub>R</sub>	5	10		V
Junction capacitance	V <sub>R</sub> = 0, f = 1 MHz	C <sub>j</sub>		50		pF

## Chromaticity Coordinate Classification

Group	X		Y	
	min	max	min	max
31a	0.2900	0.3025	Y = 1.4x - 0.121	Y = 1.4x - 0.071
31b	0.3025	0.3150	Y = 1.4x - 0.121	Y = 1.4x - 0.071
31c	0.2900	0.3025	Y = 1.4x - 0.171	Y = 1.4x - 0.121
31d	0.3025	0.3150	Y = 1.4x - 0.171	Y = 1.4x - 0.121
41a	0.3150	0.3275	Y = 1.4x - 0.121	Y = 1.4x - 0.071
41b	0.3275	0.3400	Y = 1.4x - 0.121	Y = 1.4x - 0.071
41c	0.3150	0.3275	Y = 1.4x - 0.171	Y = 1.4x - 0.121
41d	0.3275	0.3400	Y = 1.4x - 0.171	Y = 1.4x - 0.121
51a	0.3400	0.3525	Y = 1.4x - 0.121	Y = 1.4x - 0.071
51b	0.3525	0.3650	Y = 1.4x - 0.121	Y = 1.4x - 0.071
51c	0.3400	0.3525	Y = 1.4x - 0.171	Y = 1.4x - 0.121
51d	0.3525	0.3650	Y = 1.4x - 0.171	Y = 1.4x - 0.121

tolerance ± 0.005

## Typical Characteristics ( $T_{amb} = 25\text{ }^{\circ}\text{C}$ unless otherwise specified)

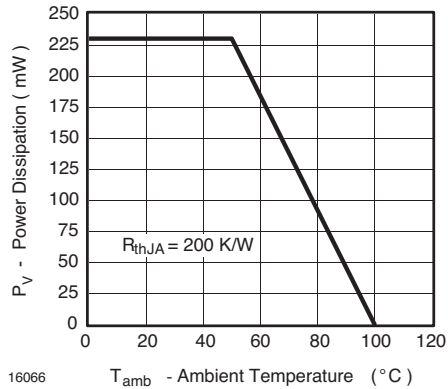

Figure 1. Power Dissipation vs. Ambient Temperature

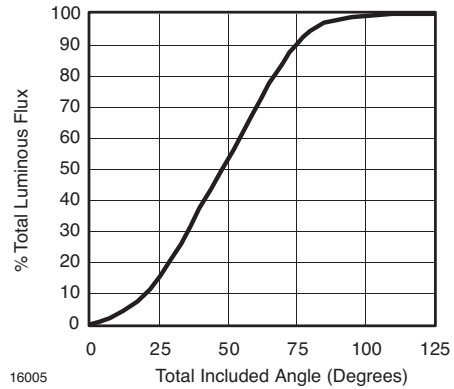

Figure 4. Percentage Total Luminous Flux vs. Total Included Angle for 60° emission angle

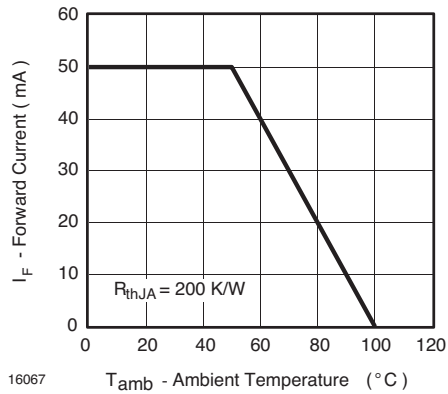

Figure 2. Forward Current vs. Ambient Temperature for InGaN

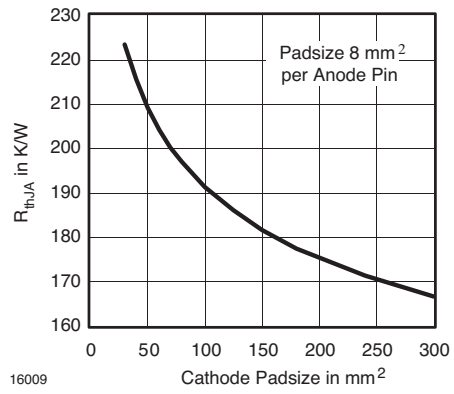

Figure 5. Thermal Resistance Junction Ambient vs. Cathode Padsizes

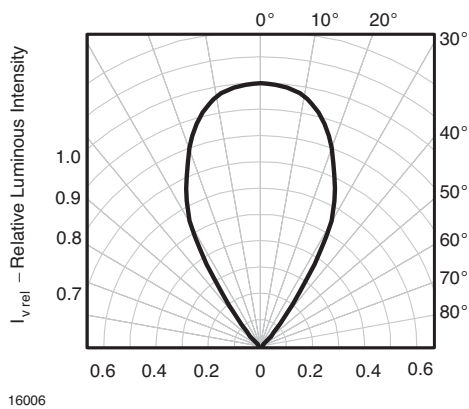

Figure 3. Rel. Luminous Intensity vs. Angular Displacement for 60° emission angle

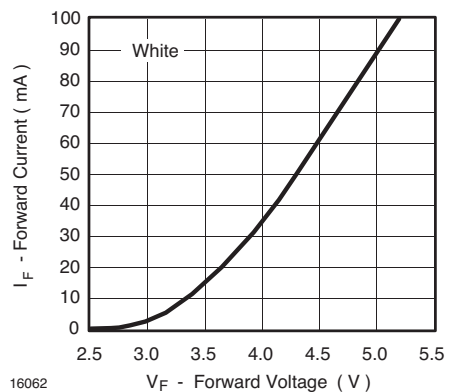
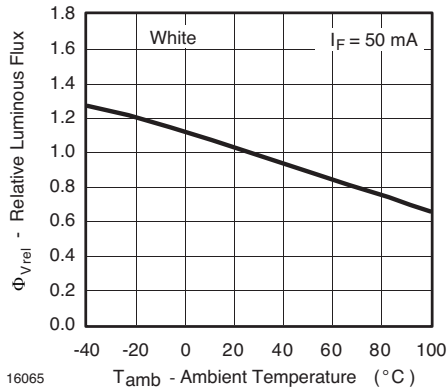
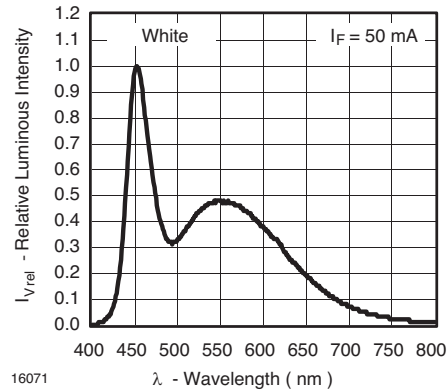

Figure 6. Forward Current vs. Forward Voltage



16065

Figure 7. Rel. Luminous Flux vs. Ambient Temperature



16071

Figure 10. Relative Intensity vs. Wavelength

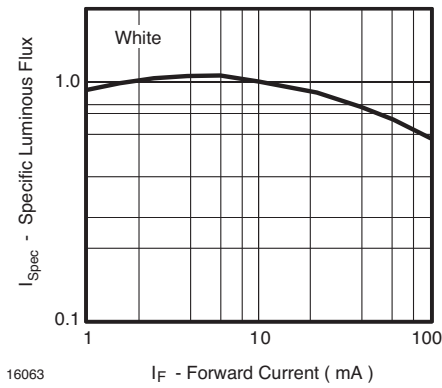

16063

Figure 8. Specific Luminous Flux vs. Forward Current

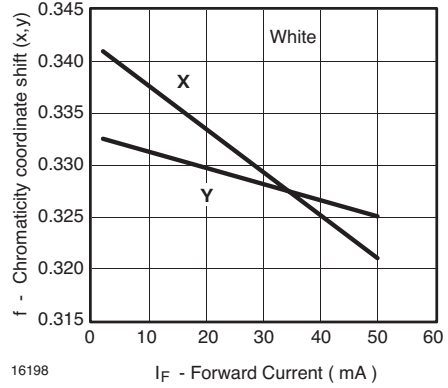

16198

Figure 11. Chromaticity Coordinate Shift vs. Forward Current

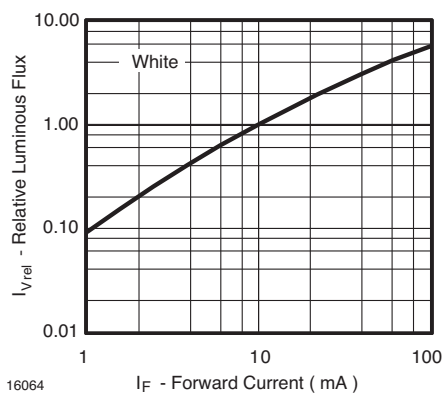

16064

Figure 9. Relative Luminous Flux vs. Forward Current

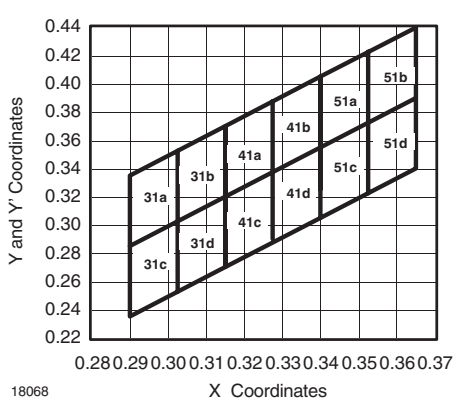

18068

Figure 12. Coordinates of Colorgroups

## Package Dimensions in mm

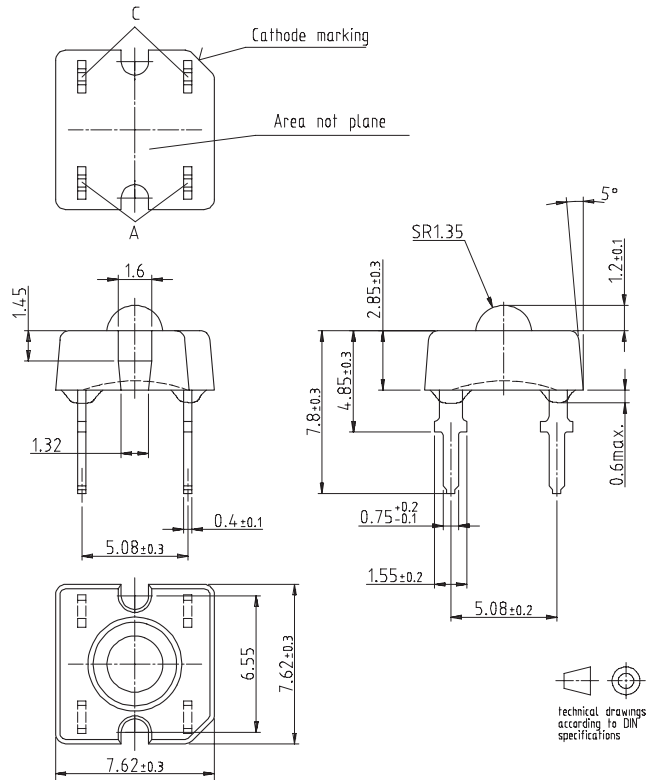

16004

### Ozone Depleting Substances Policy Statement

It is the policy of **Vishay Semiconductor GmbH** to

1. Meet all present and future national and international statutory requirements.
2. Regularly and continuously improve the performance of our products, processes, distribution and operating systems with respect to their impact on the health and safety of our employees and the public, as well as their impact on the environment.

It is particular concern to control or eliminate releases of those substances into the atmosphere which are known as ozone depleting substances (ODSs).

The Montreal Protocol (1987) and its London Amendments (1990) intend to severely restrict the use of ODSs and forbid their use within the next ten years. Various national and international initiatives are pressing for an earlier ban on these substances.

**Vishay Semiconductor GmbH** has been able to use its policy of continuous improvements to eliminate the use of ODSs listed in the following documents.

1. Annex A, B and list of transitional substances of the Montreal Protocol and the London Amendments respectively
2. Class I and II ozone depleting substances in the Clean Air Act Amendments of 1990 by the Environmental Protection Agency (EPA) in the USA
3. Council Decision 88/540/EEC and 91/690/EEC Annex A, B and C (transitional substances) respectively.

**Vishay Semiconductor GmbH** can certify that our semiconductors are not manufactured with ozone depleting substances and do not contain such substances.

**We reserve the right to make changes to improve technical design  
and may do so without further notice.**

Parameters can vary in different applications. All operating parameters must be validated for each customer application by the customer. Should the buyer use Vishay Semiconductors products for any unintended or unauthorized application, the buyer shall indemnify Vishay Semiconductors against all claims, costs, damages, and expenses, arising out of, directly or indirectly, any claim of personal damage, injury or death associated with such unintended or unauthorized use.

Vishay Semiconductor GmbH, P.O.B. 3535, D-74025 Heilbronn, Germany  
Telephone: 49 (0)7131 67 2831, Fax number: 49 (0)7131 67 2423