

## Low Current 13 mm Seven Segment Display

Color	Type	Circuitry
High efficiency red	TDSL5150	Common anode
High efficiency red	TDSL5160	Common cathode

### Description

The TDSL51.0 series are 13 mm character seven segment low current LED displays in a very compact package.

The displays are designed for a viewing distance up to 7 meters and available in high efficiency red. The grey package surface and the evenly lighted untinted segments provide an optimum on-off contrast.

All displays are categorized in luminous intensity groups. That allows users to assemble displays with uniform appearance.

Typical applications include instruments, panel meters, point-of-sale terminals and household equipment.

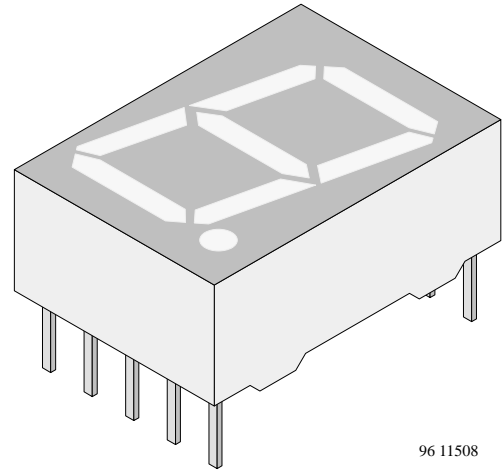

96 11508

### Features

- Low power consumption
- Suitable for DC and multiplex operation
- Evenly lighted segments
- Grey package surface
- Untinted segments
- Luminous intensity categorized
- Wide viewing angle

### Applications

Panel meters  
Test- and measure- equipment  
Point-of-sale terminals  
Control units

### Absolute Maximum Ratings

$T_{amb} = 25^{\circ}\text{C}$ , unless otherwise specified

#### TDSL5150 /TDSL5160

Parameter	Test Conditions	Symbol	Value	Unit
Reverse voltage per segment		$V_R$	6	V
DC forward current per segment		$I_F$	15	mA
Peak forward current per segment		$I_{FM}$	45	mA
Surge forward current per segment	$t_p \leq 10 \mu\text{s}$ (non repetitive)	$I_{FSM}$	100	mA
Power dissipation	$T_{amb} \leq 45^{\circ}\text{C}$	$P_V$	320	mW
Junction temperature		$T_j$	100	$^{\circ}\text{C}$
Operating temperature range		$T_{amb}$	-40 to + 85	$^{\circ}\text{C}$
Storage temperature range		$T_{stg}$	-40 to + 85	$^{\circ}\text{C}$
Soldering temperature	$t \leq 3 \text{ sec}$ , 2mm below seating plane	$T_{sd}$	260	$^{\circ}\text{C}$
Thermal resistance LED junction/ambient		$R_{thJA}$	180	K/W

### Optical and Electrical Characteristics

$T_{amb} = 25^{\circ}\text{C}$ , unless otherwise specified

#### High efficiency red (TDSL5150 , TDSL5160 )

Parameter	Test Conditions	Type	Symbol	Min	Typ	Max	Unit
Luminous intensity per segment (digit average) <sup>1)</sup>	$I_F = 2 \text{ mA}$		$I_V$	280	400		$\mu\text{cd}$
	$I_F = 5 \text{ mA}$		$I_V$		1600		$\mu\text{cd}$
	$I_F = 20 \text{ mA}$ , $t_p/T = 0.25$		$I_V$		2000		$\mu\text{cd}$
Dominant wavelength	$I_F = 2 \text{ mA}$		$\lambda_d$	612		625	nm
Peak wavelength	$I_F = 2 \text{ mA}$		$\lambda_p$		635		nm
Angle of half intensity	$I_F = 2 \text{ mA}$		$\phi$		$\pm 50$		deg
Forward voltage per segment	$I_F = 2 \text{ mA}$		$V_F$		1.8	2.4	V
	$I_F = 20 \text{ mA}$		$V_F$		2.7	3	V
Reverse voltage per segment	$I_R = 10 \mu\text{A}$		$V_R$	6	20		V
Junction capacitance	$V_R = 0$ , $f = 1 \text{ MHz}$		$C_j$		30		pF
<sup>1)</sup> $I_{V_{min}}$ and $I_V$ groups are mean	values of segments a to g						

**Typical Characteristics** ( $T_{amb} = 25^{\circ}\text{C}$ , unless otherwise specified)

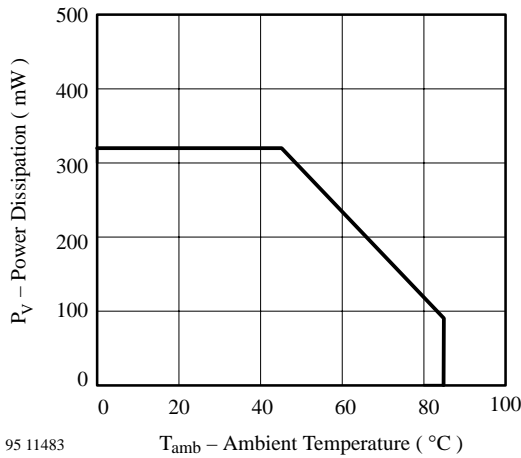

Figure 1. Power Dissipation vs. Ambient Temperature

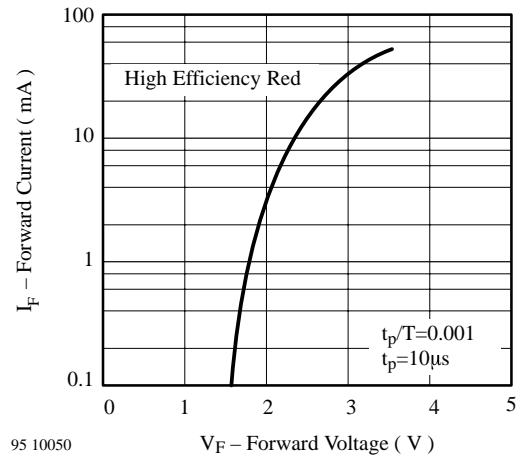

Figure 4. Forward Current vs. Forward Voltage

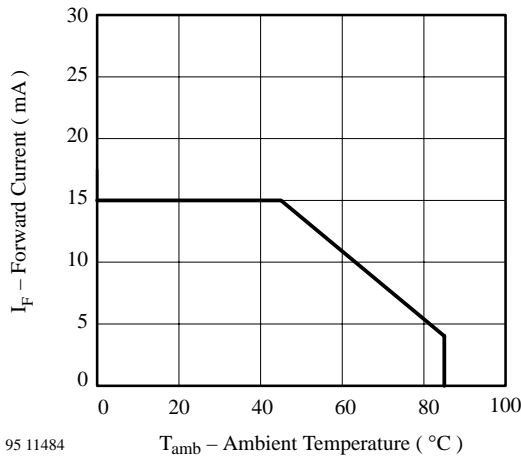

Figure 2. Forward Current vs. Ambient Temperature

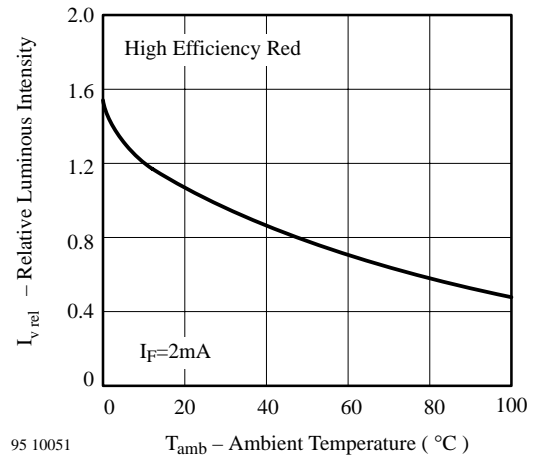

Figure 5. Rel. Luminous Intensity vs. Ambient Temperature

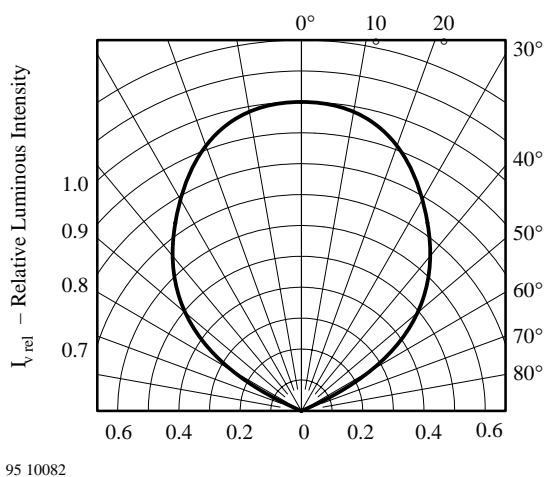

Figure 3. Rel. Luminous Intensity vs. Angular Displacement

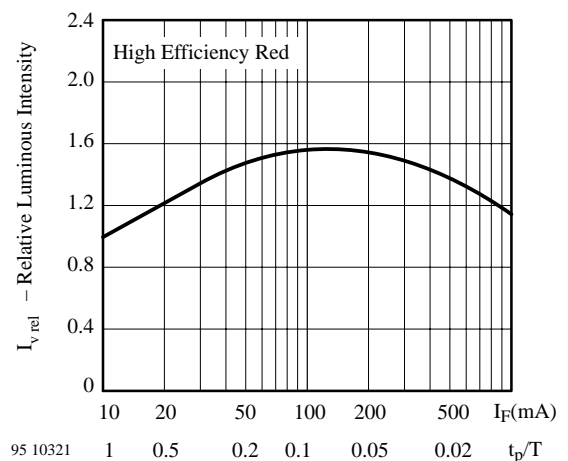

Figure 6. Rel. Lumin. Intensity vs. Forw. Current/Duty Cycle

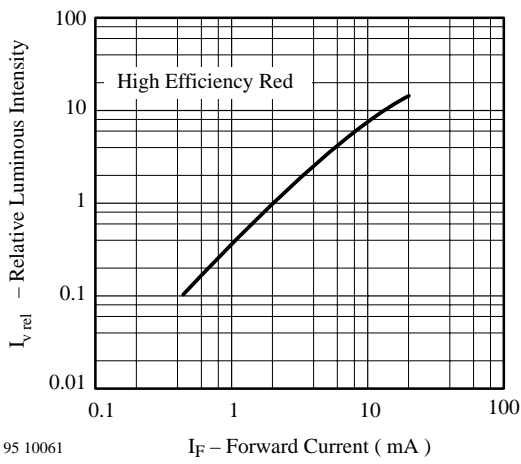

Figure 7. Relative Luminous Intensity vs. Forward Current

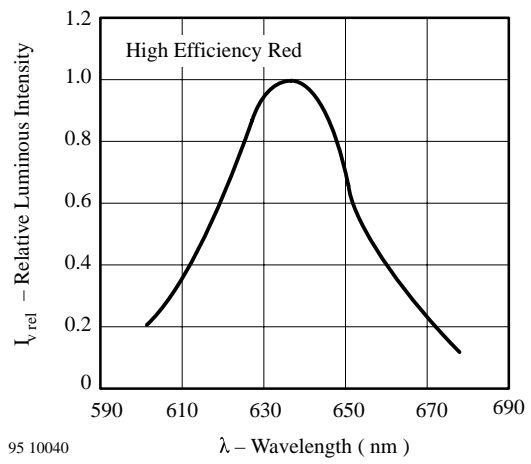
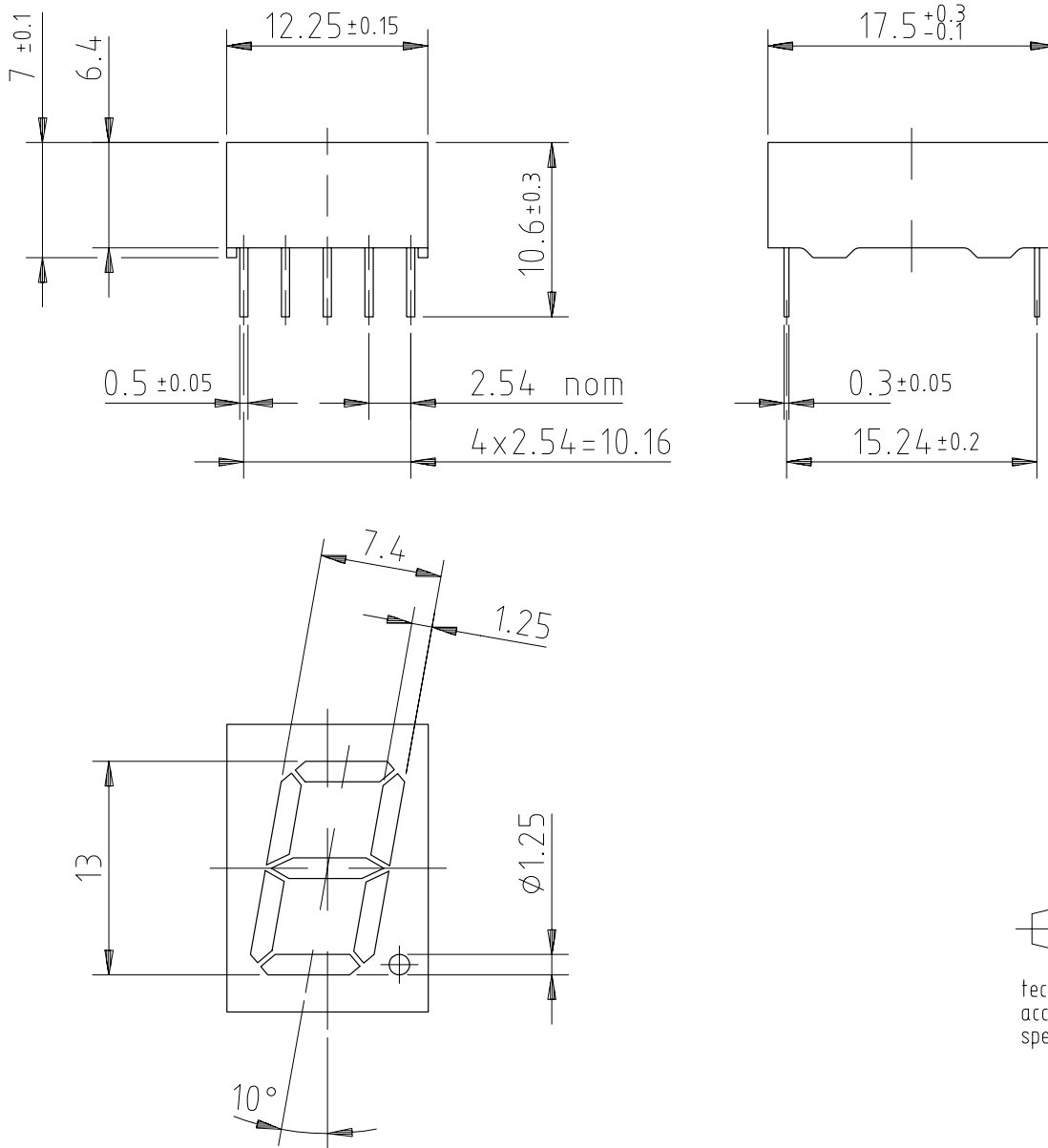
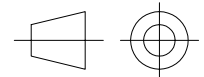

Figure 8. Relative Luminous Intensity vs. Wavelength

**Dimensions in mm**



95 11344



technical drawings  
according to DIN  
specifications

### Pin connections

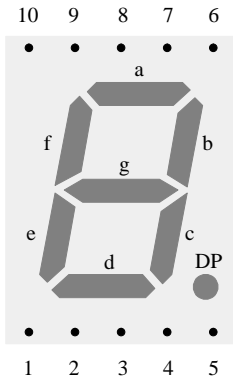

- 1 e
- 2 d
- 3 A (K)
- 4 c
- 5 DP
- 6 b
- 7 a
- 8 A (K)
- 9 f
- 10 g

95 10896



## **Ozone Depleting Substances Policy Statement**

It is the policy of **Vishay Semiconductor GmbH** to

1. Meet all present and future national and international statutory requirements.
2. Regularly and continuously improve the performance of our products, processes, distribution and operating systems with respect to their impact on the health and safety of our employees and the public, as well as their impact on the environment.

It is particular concern to control or eliminate releases of those substances into the atmosphere which are known as ozone depleting substances (ODSs).

The Montreal Protocol (1987) and its London Amendments (1990) intend to severely restrict the use of ODSs and forbid their use within the next ten years. Various national and international initiatives are pressing for an earlier ban on these substances.

**Vishay Semiconductor GmbH** has been able to use its policy of continuous improvements to eliminate the use of ODSs listed in the following documents.

1. Annex A, B and list of transitional substances of the Montreal Protocol and the London Amendments respectively
2. Class I and II ozone depleting substances in the Clean Air Act Amendments of 1990 by the Environmental Protection Agency (EPA) in the USA
3. Council Decision 88/540/EEC and 91/690/EEC Annex A, B and C (transitional substances) respectively.

**Vishay Semiconductor GmbH** can certify that our semiconductors are not manufactured with ozone depleting substances and do not contain such substances.

**We reserve the right to make changes to improve technical design and may do so without further notice.**

Parameters can vary in different applications. All operating parameters must be validated for each customer application by the customer. Should the buyer use Vishay-Telefunken products for any unintended or unauthorized application, the buyer shall indemnify Vishay-Telefunken against all claims, costs, damages, and expenses, arising out of, directly or indirectly, any claim of personal damage, injury or death associated with such unintended or unauthorized use.

Vishay Semiconductor GmbH, P.O.B. 3535, D-74025 Heilbronn, Germany  
Telephone: 49 (0)7131 67 2831, Fax number: 49 (0)7131 67 2423