

# TC7WBD126FK

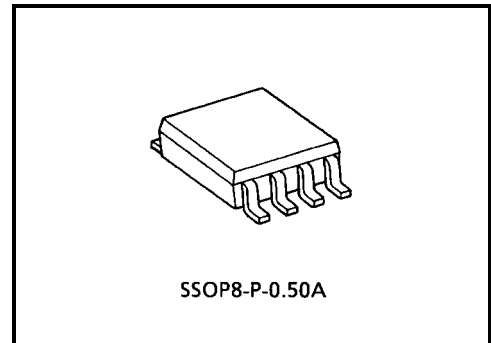
## Dual Bus Switch with Level Shift

The TC7WBD126FK is a low on-resistance, high-speed CMOS 2-bit bus switch. This bus switch allows the connections or disconnections to be made with minimal propagation delay while maintaining Low power dissipation which is the feature of CMOS.

When output enable (OE) is at High level, the switch is on; when at Low level, the switch is off.

The internal diode which adds to power supply line is enable to realize the shift of signal level from 5 V to 3.3 V. (Note 1)

All inputs are equipped with protector circuits to protect the device from static discharge.



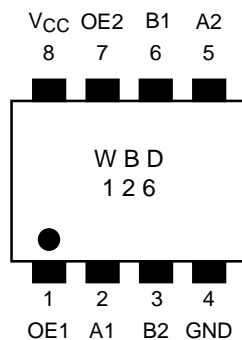
Weight: 0.01 g (typ.)

## Features

- Operating voltage:  $V_{CC} = 4.5\sim 5.5$  V
- High speed operation:  $t_{pd} = 0.25$  ns (max)
- Ultra-low on resistance:  $R_{ON} = 5 \Omega$  (typ.)
- Electro-static discharge (ESD) performance:  $\pm 200$  V or more (JEITA)  
 $\pm 2000$  V or more (MIL)
- TTL level input (control input)
- Package: US8

Note 1: In case that over-shoot noise is detected, this device should be used with clamp diode to prevent the next stage device from over-stress.

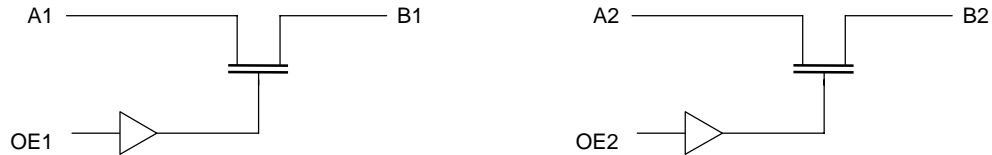
## Pin Assignment (top view)



## Truth Table

Inputs	Function
OE	
L	Disconnect
H	A port = B port

## System Diagram



## Maximum Ratings

Characteristics	Symbol	Rating	Unit
Power supply range	$V_{CC}$	-0.5~7.0	V
DC input voltage	$V_{IN}$	-0.5~7.0	V
DC switch voltage	$V_S$	-0.5~7.0	V
Input diode current	$I_{IK}$	-50	mA
Continuous channel current	$I_S$	128	mA
Power dissipation	$P_D$	200	mW
DC $V_{CC}/GND$ current	$I_{CC}/I_{GND}$	$\pm 100$	mA
Storage temperature	$T_{stg}$	-65~150	$^{\circ}C$

## Recommended Operating Conditions

Characteristics	Symbol	Rating	Unit
Supply voltage	$V_{CC}$	4.5~5.5	V
Input voltage	$V_{IN}$	0~5.5	V
Switch voltage	$V_S$	0~5.5	V
Operating temperature	$T_{opr}$	-40~85	$^{\circ}C$
Input rise and fall time	dt/dv	0~10	ns/V

**Electrical Characteristics**

**DC Characteristics (Ta = -40~85°C)**

Characteristics		Symbol	Test Condition	V <sub>CC</sub> (V)	Min	Typ. (Note 2)	Max	Unit
Input voltage	"H" level	V <sub>IH</sub>	—	4.5-5.5	2.0	—	—	V
	"L" level	V <sub>IL</sub>	—	4.5-5.5	—	—	0.8	
High-level output voltage		V <sub>OH</sub>	Figure 4	—	—	—	—	—
Input leakage current		I <sub>IN</sub>	V <sub>IN</sub> = 0~5.5 V	4.5-5.5	—	—	±1.0	μA
Power off leakage current		I <sub>OFF</sub>	A, B, OE = 0~5.5 V	0	—	—	±1.0	μA
Off-state leakage current (switch off)		I <sub>SZ</sub>	A, B = 0~5.5 V, OE = GND	4.5-5.5	—	—	±1.0	μA
ON resistance (Note 3)	R <sub>ON</sub>	V <sub>IS</sub> = 0 V	I <sub>IS</sub> = 30 mA	4.5	—	5	7	Ω
			I <sub>IS</sub> = 64 mA	4.5	—	5	7	
		V <sub>IS</sub> = 2.4 V, I <sub>IS</sub> = 15 mA			4.5	—	35	
Quiescent supply current	I <sub>CC</sub>	V <sub>IN</sub> = V <sub>CC</sub> or GND I <sub>OUT</sub> = 0	Switch ON	5.5	—	—	1.5	mA
			Switch OFF	5.5	—	—	10	μA
	ΔI <sub>CC</sub>	V <sub>IN</sub> = 3.4 V (one input)	(Note 4)	5.5	—	—	2.5	mA

Note 2: Typical values are at V<sub>CC</sub> = 5 V and Ta = 25°C.

Note 3: Measured by the voltage drop between A and B pins at the indicated current through the switch. On resistance is determined by the lower of the voltages on the two (A or B) pins.

Note 4: Quiescent supply current at V<sub>CC</sub> = 3.4 V will be sum of I<sub>CC</sub> and ΔI<sub>CC</sub>.

**AC Characteristics (Ta = -40~85°C)**

Characteristics		Symbol	Test Condition	V <sub>CC</sub> (V)	Min	Max	Unit
Propagation delay time (bus to bus)		t <sub>pLH</sub> t <sub>pHL</sub>	Figure 1, Figure 2 (Note 5)	4.5	—	0.25	ns
Output enable time		t <sub>pZL</sub> t <sub>pZH</sub>	Figure 1, Figure 3	4.5	—	4.5	ns
Output disable time		t <sub>pLZ</sub> t <sub>pHZ</sub>	Figure 1, Figure 3	4.5	—	5.5	ns

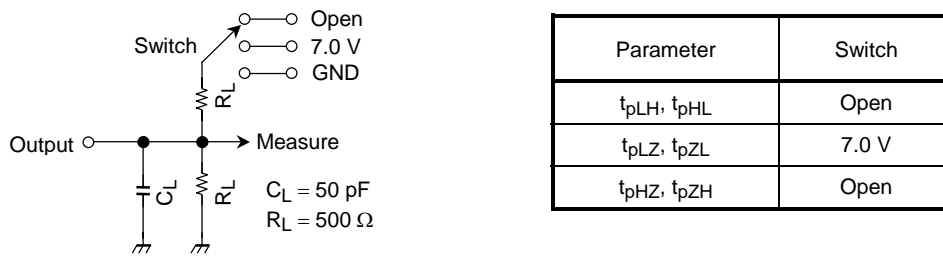
Note 5: The propagation delay time is calculated by the RC (on-resistance and load capacitance) time constant.

**Capacitive Characteristics (Ta = 25°C)**

Characteristics		Symbol	Test Condition	V <sub>CC</sub> (V)	Typ.	Unit
Control pin input capacitance		C <sub>IN</sub>	(Note 6)	5.0	3	pF
Switch terminal capacitance		C <sub>I/O</sub>	OE = GND (Note 6)	5.0	10	pF

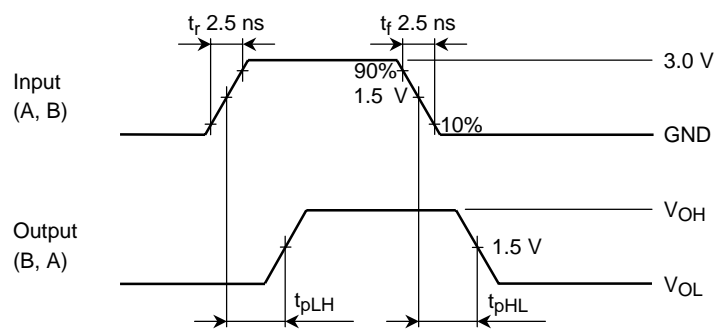
Note 6: This parameter is guaranteed by design.

**AC Test Circuit**

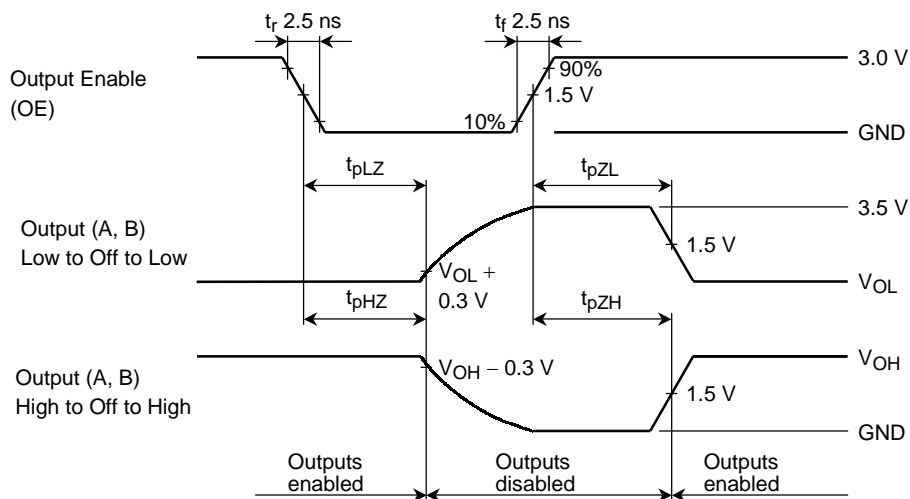


**Figure 1**

**AC Waveform**

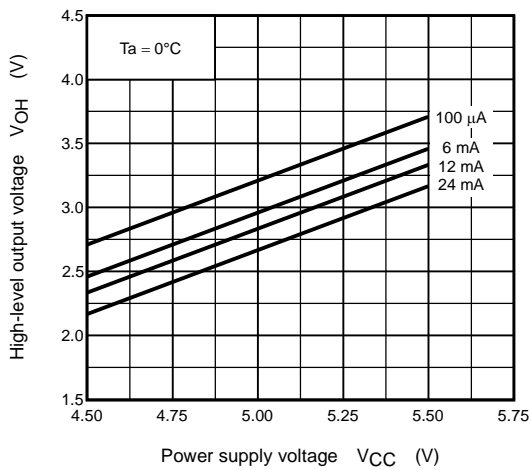
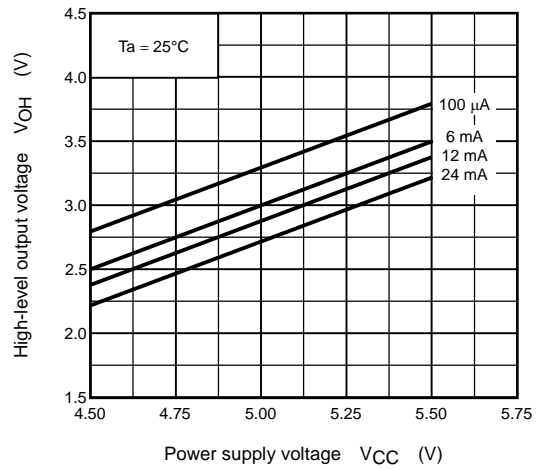
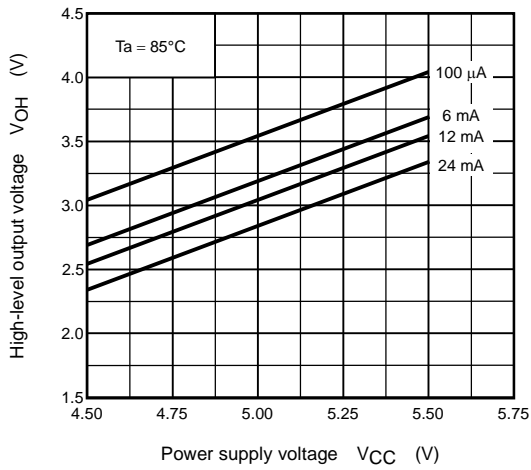


**Figure 2  $t_{pLH}, t_{pHL}$**



**Figure 3  $t_{pLZ}, t_{pHZ}, t_{pZL}, t_{pZH}$**

**$V_{OH} - V_{CC}$  Characteristics (typ.)**

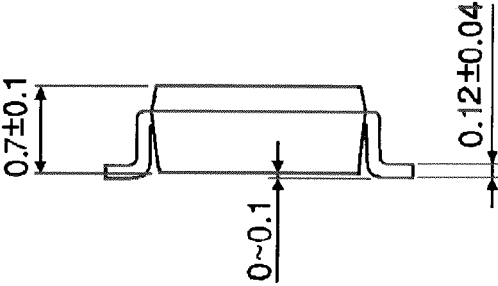
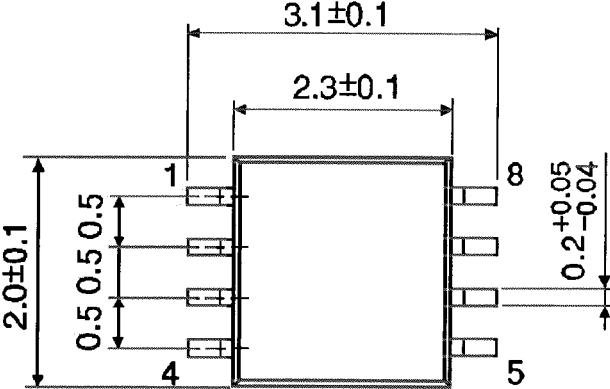


**Figure 4**

Package Dimensions

SSOP8-P-0.50A

Unit : mm



Weight: 0.01 g (typ.)

**RESTRICTIONS ON PRODUCT USE**

000707EBA

- TOSHIBA is continually working to improve the quality and reliability of its products. Nevertheless, semiconductor devices in general can malfunction or fail due to their inherent electrical sensitivity and vulnerability to physical stress. It is the responsibility of the buyer, when utilizing TOSHIBA products, to comply with the standards of safety in making a safe design for the entire system, and to avoid situations in which a malfunction or failure of such TOSHIBA products could cause loss of human life, bodily injury or damage to property.  
In developing your designs, please ensure that TOSHIBA products are used within specified operating ranges as set forth in the most recent TOSHIBA products specifications. Also, please keep in mind the precautions and conditions set forth in the "Handling Guide for Semiconductor Devices," or "TOSHIBA Semiconductor Reliability Handbook" etc..
- The TOSHIBA products listed in this document are intended for usage in general electronics applications (computer, personal equipment, office equipment, measuring equipment, industrial robotics, domestic appliances, etc.). These TOSHIBA products are neither intended nor warranted for usage in equipment that requires extraordinarily high quality and/or reliability or a malfunction or failure of which may cause loss of human life or bodily injury ("Unintended Usage"). Unintended Usage include atomic energy control instruments, airplane or spaceship instruments, transportation instruments, traffic signal instruments, combustion control instruments, medical instruments, all types of safety devices, etc.. Unintended Usage of TOSHIBA products listed in this document shall be made at the customer's own risk.
- The products described in this document are subject to the foreign exchange and foreign trade laws.
- The information contained herein is presented only as a guide for the applications of our products. No responsibility is assumed by TOSHIBA CORPORATION for any infringements of intellectual property or other rights of the third parties which may result from its use. No license is granted by implication or otherwise under any intellectual property or other rights of TOSHIBA CORPORATION or others.
- The information contained herein is subject to change without notice.