



STGW20NB60KD

N-CHANNEL 20A - 600V TO-247 SHORT CIRCUIT PROOF PowerMESH™ IGBT

Table 1: General Features

TYPE	V _{CES}	V _{CE(sat)} (Max) @25°C	I _C @100°C
STGW20NB60KD	600 V	< 2.8 V	25 A

- OFF LOSSES INCLUDE TAIL CURRENT
- HIGH CURRENT CAPABILITY
- HIGH INPUT IMPEDANCE (VOLTAGE DRIVEN)
- LOW ON-VOLTAGE DROP (V_{cesat})
- LOW ON-LOSSES
- LOW GATE CHARGE
- VERY HIGH FREQUENCY OPERATION
- SHORT CIRCUIT RATED
- LATCH CURRENT FREE OPERATION

DESCRIPTION

Using the latest high voltage technology based on a patented strip layout, STMicroelectronics has designed an advanced family of IGBTs, the PowerMESH™ IGBTs, with outstanding performances. The suffix "K" identifies a family optimized for high frequency motor control applications with short circuit withstand capability.

APPLICATIONS

- HIGH FREQUENCY MOTOR CONTROLS
- U.P.S
- WELDING EQUIPMENTS

Table 2: Order Codes

SALES TYPE	MARKING	PACKAGE	PACKAGING
STGW20NB60KD	GW20NB60KD	TO-247	TUBE

Figure 1: Package

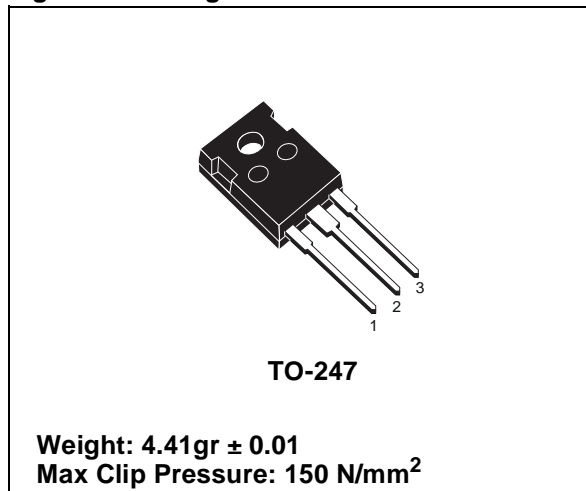

Figure 2: Internal Schematic Diagram

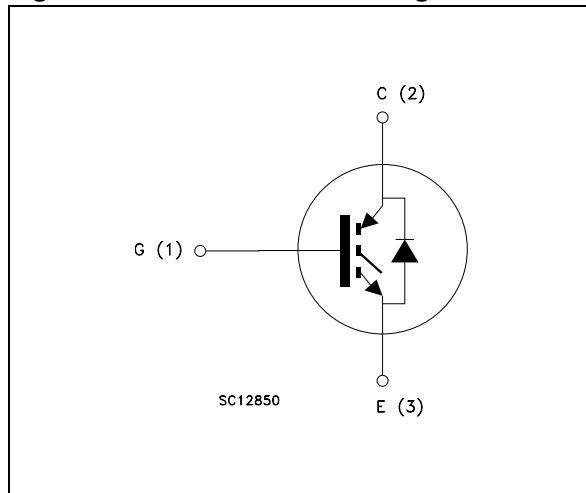

Table 3: Absolute Maximum ratings

Symbol	Parameter	Value	Unit
V _{CES}	Collector-Emitter Voltage (V _{GS} = 0)	600	V
V _{ECR}	Reverse Battery Protection	20	V
V _{GE}	Gate-Emitter Voltage	± 20	V
I _C	Collector Current (continuous) at 25°C (#)	50	A
I _C	Collector Current (continuous) at 100°C (#)	25	A
I _{CM} (1)	Collector Current (pulsed)	100	A
T _{SC}	Short Circuit Withstand	10	µs
P _{TOT}	Total Dissipation at T _C = 25°C	170	W
	Derating Factor	1.2	W/°C
T _{stg}	Storage Temperature	- 55 to 150	°C
T _j	Operating Junction Temperature		

(1)Pulse width limited by max. junction temperature.

Table 4: Thermal Data

		Min.	Typ.	Max.	
R _{thj-case}	Thermal Resistance Junction-case	--	--	0.73	°C/W
R _{thj-amb}	Thermal Resistance Junction-ambient	--	--	50	°C/W

Electrical Characteristics (T_{case} =25°C unless otherwise specified)

Table 5: Off

Symbol	Parameter	Test Conditions	Min.	Typ.	Max.	Unit
V _{BR(CES)}	Collectro-Emitter Breakdown Voltage	I _C = 250 µA, V _{GE} = 0	600			V
I _{CES}	Collector-Emitter Leakage Current (V _{CE} = 0)	V _{GE} = Max Rating T _C =25°C T _C =125°C			10 100	µA µA
I _{GES}	Gate-Emitter Leakage Current (V _{CE} = 0)	V _{GE} = ± 20 V , V _{CE} = 0			± 100	nA

Table 6: On

Symbol	Parameter	Test Conditions	Min.	Typ.	Max.	Unit
V _{GE(th)}	Gate Threshold Voltage	V _{CE} = V _{GE} , I _C = 250 µA	5		7	V
V _{CE(SAT)}	Collector-Emitter Saturation Voltage	V _{GE} = 15 V, I _C = 20A, T _j = 25°C V _{GE} = 15 V, I _C = 20A, T _j = 125°C		2.3 1.9	2.8	V V

(#) Calculated according to the iterative formula:

$$I_C(T_C) = \frac{T_{JMAX} - T_C}{R_{THJ-C} \times V_{CESAT(MAX)}(T_C, I_C)}$$

ELECTRICAL CHARACTERISTICS (CONTINUED)

Table 7: Dynamic

Symbol	Parameter	Test Conditions	Min.	Typ.	Max.	Unit
g_{fs}	Forward Transconductance	$V_{CE} = 25 \text{ V}, I_C = 20 \text{ A}$		8		S
C_{ies} C_{oes} C_{res}	Input Capacitance Output Capacitance Reverse Transfer Capacitance	$V_{CE} = 25 \text{ V}, f = 1 \text{ MHz}, V_{GE} = 0$		1560 190 38		pF pF pF
Q_g Q_{ge} Q_{gc}	Total Gate Charge Gate-Emitter Charge Gate-Collector Charge	$V_{CE} = 480 \text{ V}, I_C = 20 \text{ A},$ $V_{GE} = 15 \text{ V},$ (see Figure 19)		85 14.4 51	115	nC nC nC
tscw	Short Circuit Withstand Time	$V_{ce} = 0.5 \text{ BV}_{ces}, T_j = 125^\circ\text{C}$ $R_G = 10 \Omega, V_{GE} = 15 \text{ V}$	10			μs

Table 8: Switching On

Symbol	Parameter	Test Conditions	Min.	Typ.	Max.	Unit
$t_{d(on)}$ t_r	Turn-on Delay Time Current Rise Time	$V_{CC} = 480 \text{ V}, I_C = 20 \text{ A}$ $R_G = 10 \Omega, V_{GE} = 15 \text{ V}, T_j = 25^\circ\text{C}$ (see Figure 17)		39 35		ns ns
$(di/dt)_{on}$ Eon (2)	Turn-on Current Slope Turn-on Switching Losses	$V_{CC} = 480 \text{ V}, I_C = 20 \text{ A}$ $R_G = 10 \Omega, V_{GE} = 15 \text{ V}, T_j = 125^\circ\text{C}$ (see Figure 17)		453 675		A/ μs μJ

2) Eon is the turn-on losses when a typical diode is used in the test circuit in Figure 17. If the IGBT is offered in a package with a co-pack diode, the co-pack diode is used as external diode.

Table 9: Switching Off

Symbol	Parameter	Test Conditions	Min.	Typ.	Max.	Unit
$t_r(V_{off})$ t_c $t_{d(off)}$ t_f E _{off} (3) E _{ts}	Off Voltage Rise Time Cross-over Time Turn-off Delay Time Current Fall Time Turn-off Switching Loss Total Switching Loss	$V_{CC} = 480 \text{ V}, I_C = 20 \text{ A},$ $R_{GE} = 10 \Omega, V_{GE} = 15 \text{ V}$ $T_j = 25^\circ\text{C}$ (see Figure 17)		25 160 105 95 0.5 0.9		ns ns ns ns mJ mJ
$t_r(V_{off})$ t_c $t_{d(off)}$ t_f E _{off} (3) E _{ts}	Off Voltage Rise Time Cross-over Time Turn-off Delay Time Current Fall Time Turn-off Switching Loss Total Switching Loss	$V_{CC} = 480 \text{ V}, I_C = 20 \text{ A},$ $R_{GE} = 10 \Omega, V_{GE} = 15 \text{ V}$ $T_j = 125^\circ\text{C}$ (see Figure 17)		46 175 130 150 0.70 1.35		ns ns ns ns mJ mJ

(3) Turn-off losses include also the tail of the collector current.

Table 10: Collector-Emitter Diode

Symbol	Parameter	Test Conditions	Min.	Typ.	Max.	Unit
I_f	Forward Current				20	A
I_{fm}	Forward Current pulsed				80	A
V_f	Forward On-Voltage	$I_f = 10\text{ A}$ $I_f = 10\text{ A}, T_j = 125\text{ °C}$		1.27 1	2.0	V V
t_{rr}	Reverse Recovery Time	$I_f = 10\text{ A}, V_R = 27\text{ V},$ $T_j = 125\text{ °C}, di/dt = 100\text{ A}/\mu\text{s}$ (see Figure 20)		80.5		ns
Q_{rr}	Reverse Recovery Charge			181		nC
I_{rrm}	Reverse Recovery Current			4.5		A

Figure 3: Output Characteristics

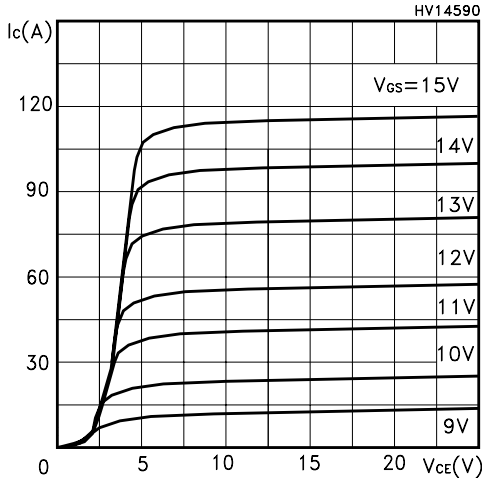

Figure 4: Transconductance

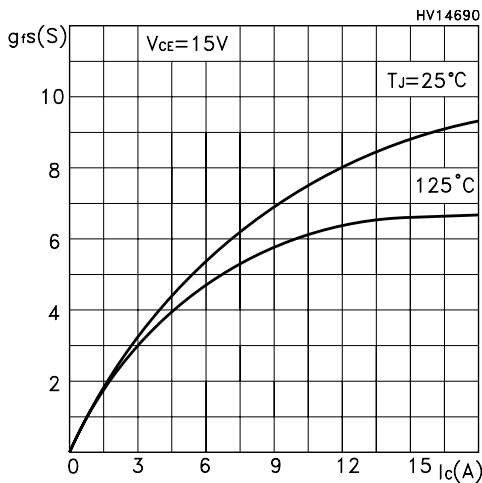

Figure 5: Collector-Emitter On Voltage vs Collector Current

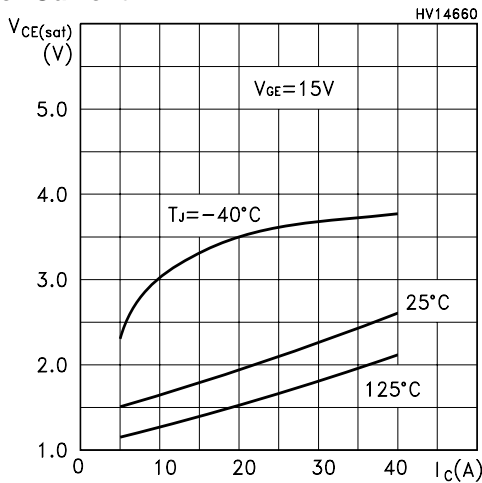

Figure 6: Transfer Characteristics

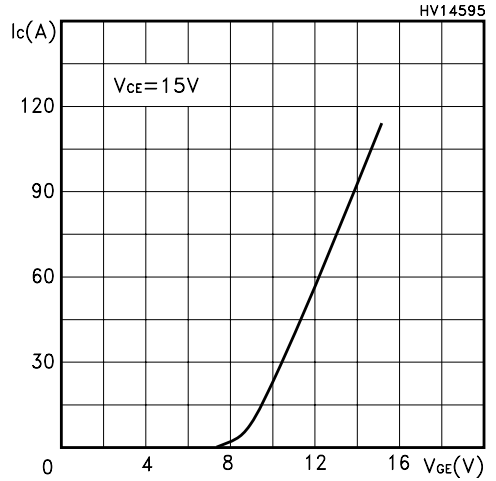

Figure 7: Collector-Emitter On Voltage vs Temperature

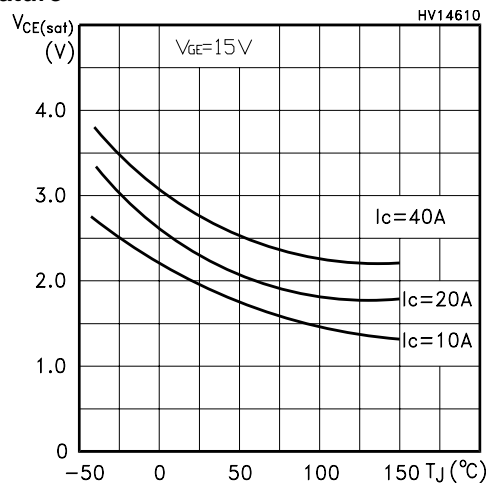

Figure 8: Normalized Gate Threshold vs Temperature

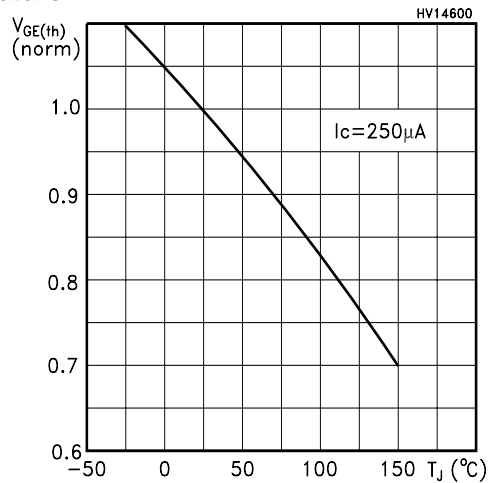

Figure 9: Normalized Breakdown Voltage vs Temperature

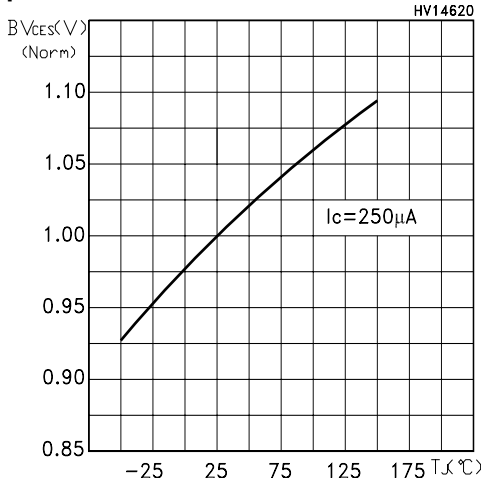

Figure 10: Capacitance Variations

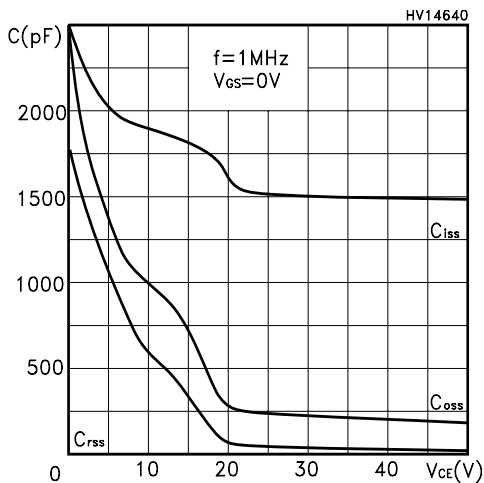

Figure 11: Turn-Off Energy Losses vs Temperature

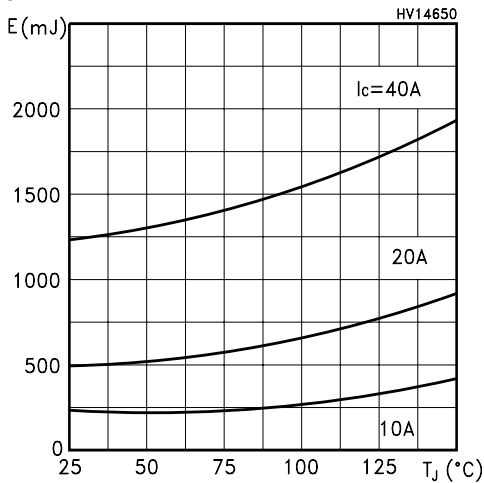

Figure 12: Gate Charge vs Gate-Emitter Voltage

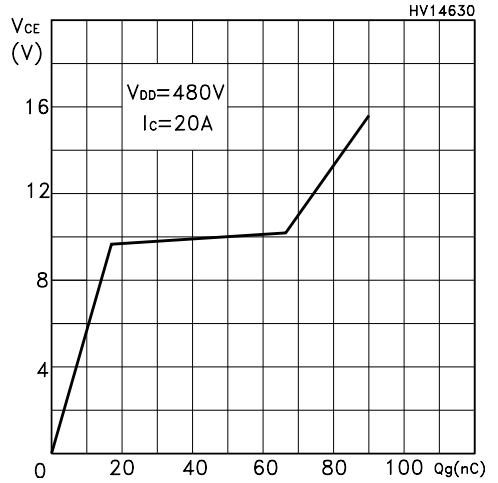

Figure 13: Diode Forward Voltage

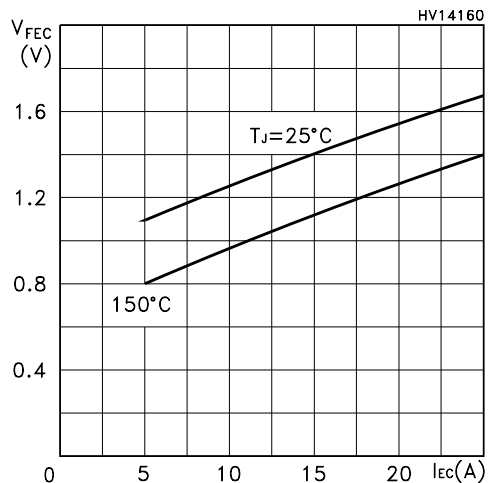

Figure 14: Total Switching Losses vs Collector Current

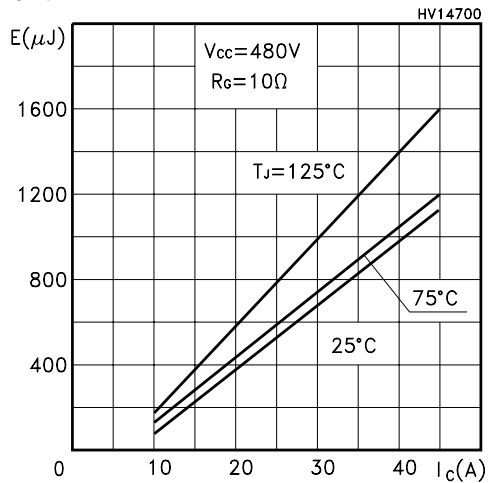

Figure 15: Thermal Impedance

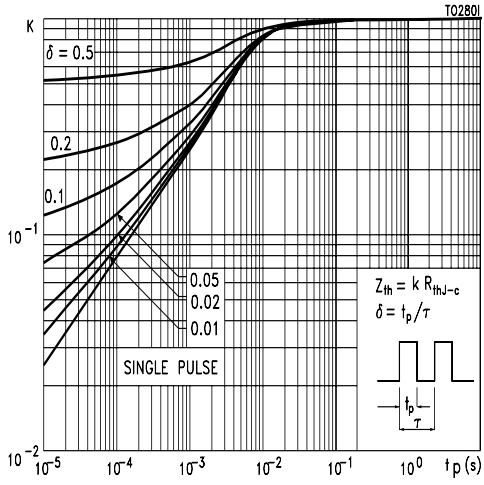
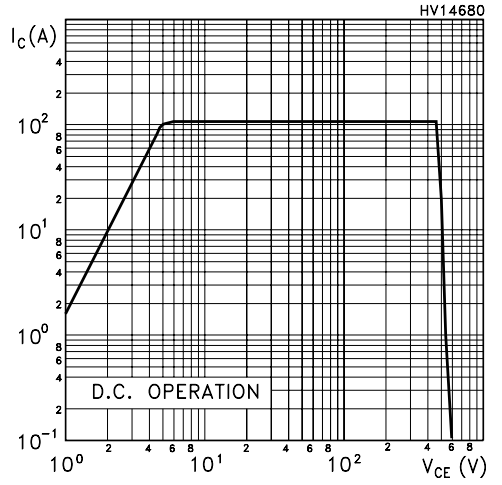

Figure 16: Turn-Off SOA



TO-247 MECHANICAL DATA

DIM.	mm.			inch		
	MIN.	TYP.	MAX.	MIN.	TYP.	MAX.
A	4.85		5.15	0.19		0.20
A1	2.20		2.60	0.086		0.102
b	1.0		1.40	0.039		0.055
b1	2.0		2.40	0.079		0.094
b2	3.0		3.40	0.118		0.134
c	0.40		0.80	0.015		0.03
D	19.85		20.15	0.781		0.793
E	15.45		15.75	0.608		0.620
e		5.45			0.214	
L	14.20		14.80	0.560		0.582
L1	3.70		4.30	0.14		0.17
L2		18.50			0.728	
øP	3.55		3.65	0.140		0.143
øR	4.50		5.50	0.177		0.216
S		5.50			0.216	

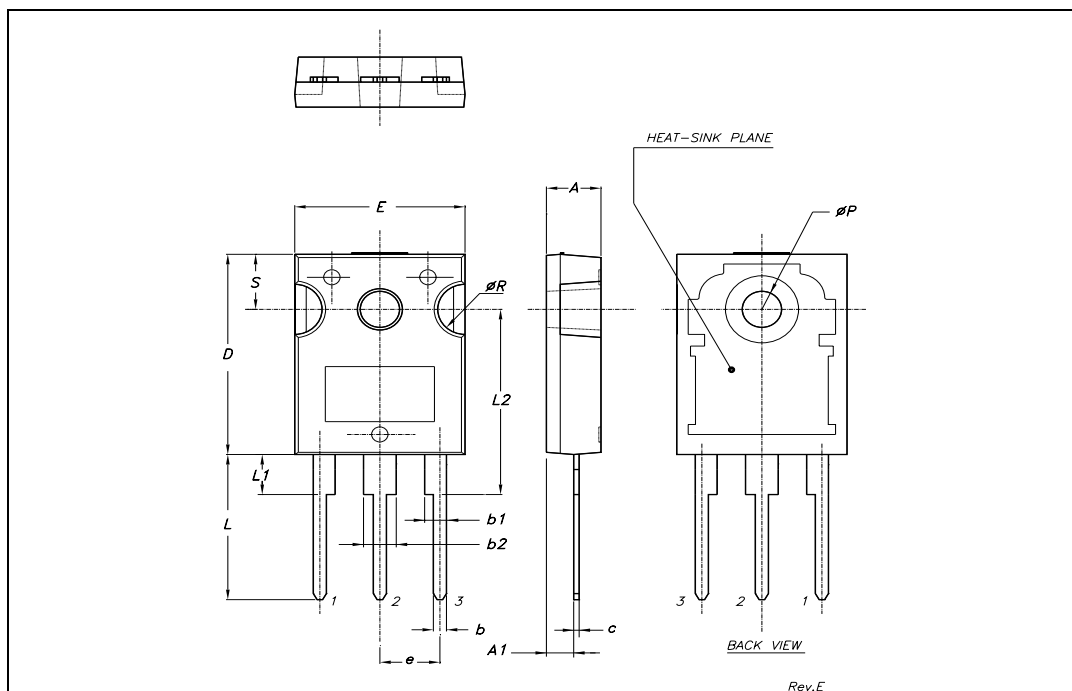

Table 11: Revision History

Date	Revision	Description of Changes
21-Mar-2005	2	New stylesheet. Some value changed on Table 3 and 4
05-Apr-2005	3	New updated values in table 3

Information furnished is believed to be accurate and reliable. However, STMicroelectronics assumes no responsibility for the consequences of use of such information nor for any infringement of patents or other rights of third parties which may result from its use. No license is granted by implication or otherwise under any patent or patent rights of STMicroelectronics. Specifications mentioned in this publication are subject to change without notice. This publication supersedes and replaces all information previously supplied. STMicroelectronics products are not authorized for use as critical components in life support devices or systems without express written approval of STMicroelectronics.

The ST logo is a registered trademark of STMicroelectronics

All other names are the property of their respective owners

© 2005 STMicroelectronics - All Rights Reserved

STMicroelectronics group of companies

Australia - Belgium - Brazil - Canada - China - Czech Republic - Finland - France - Germany - Hong Kong - India - Israel - Italy - Japan - Malaysia - Malta - Morocco - Singapore - Spain - Sweden - Switzerland - United Kingdom - United States of America