

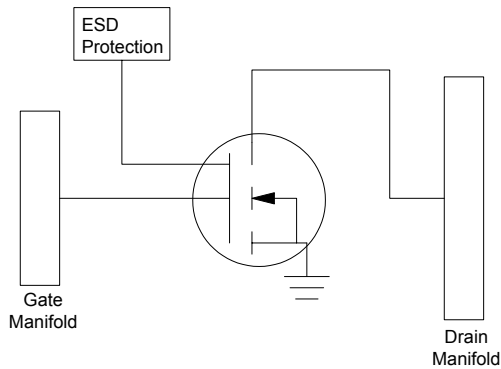

Product Description

Sirenza Microdevices' **SLD-1000** is a robust 4 Watt high performance LDMOS transistor die, designed for operation from 10 to 2700MHz. It is an excellent solution for applications requiring high linearity and efficiency. The SLD-1000 is typically used as a driver or output stage for power amplifier, or transmitter applications. These robust power transistors are fabricated using Sirenza's high performance XEMOS II™ process.

Functional Schematic Diagram



Source - Backside Contact

RF Specifications

Symbol	Parameter	Unit	Min	Typ	Max
Frequency	Frequency of Operation	MHz	10	-	2700
Gain	3.5 Watts CW, 900 MHz	dB	-	19	-
Efficiency	Drain Efficiency at 3.5 Watts CW, 900 MHz	%	-	43	-
Linearity	3 rd Order IMD at 3.5 Watts PEP (Two Tone) 900 MHz	dBc	-	-30	-
	1dB Compression (P_{1dB}) 900 MHz	Watts	-	4	-
R_{TH}	Thermal Resistance (Junction-to-Case, mounted in package)	°C/W	-	11	-

Test Conditions: Mounted in ceramic package and tested in Sirenza Evaluation Board $V_{DS} = 28.0V$, $I_{DQ} = 30mA$, $T_{Mounting\ Surface} = 25^{\circ}C$

DC Specifications

Symbol	Parameter	Unit	Min	Typical	Max
g_m	Forward Transconductance @ 30mA I_{DS}	mA / V		150	
V_{GS} Threshold	$I_{DS}=3mA$	Volts	3.0	4.2	5.0
V_{DS} Breakdown	1mA I_{DS} Current	Volts	65	70	
C_{iss}	Input Capacitance (Gate to Source) $V_{GS}=0V$, $V_{DS}=28V$	pF		5.2	
C_{rss}	Reverse Capacitance (Gate to Drain) $V_{GS}=0V$, $V_{DS}=28V$	pF		0.2	
C_{oss}	Output Capacitance (Drain to Source) $V_{GS}=0V$, $V_{DS}=28V$	pF		3.2	
R_{DSon}	Drain to Source Resistance, $V_{GS}=10V$ $V_{DS}=250mV$	Ω		3.0	3.5

The information provided herein is believed to be reliable at press time. Sirenza Microdevices assumes no responsibility for inaccuracies or omissions. Sirenza Microdevices assumes no responsibility for the use of this information, and all such information shall be entirely at the user's own risk. Prices and specifications are subject to change without notice. No patent rights or licenses to any of the circuits described herein are implied or granted to any third party. Sirenza Microdevices does not authorize or warrant any Sirenza Microdevices product for use in life-support devices and/or systems. Copyright 2005 Sirenza Microdevices, Inc. All worldwide rights reserved.

303 S. Technology Court,
Broomfield, CO 80021

Phone: (800) SMI-MMIC

1

<http://www.sirenza.com>
EDS-104291 Rev C

SLD-1000

4 Watt Discrete LDMOS FET -Bare Die

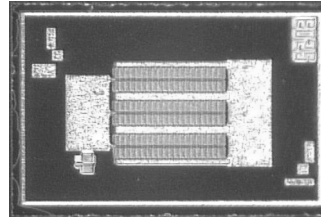

Product Features

- 4 Watt Output P_{1dB}
- Single Polarity Operation
- 19dB Gain at 900 MHz
- XeMOS II™ LDMOS
- Integrated ESD Protection, Class 1B
- Aluminum Topside Metallization
- Gold Backside Metallization

Applications

- Base Station PA Driver
- Repeaters
- Military Communications
- RFID
- GSM, CDMA, Edge, WCDMA

Quality Specifications

Parameter	Description	Unit	Typical
ESD Rating	Human Body Model	Volts	750
MTTF	200°C Channel	Hours	1.2 X 10 ⁶

Contact Description

Pad #	Function	Description
1	Gate	Aluminum metallized manifold MOSFET Gate with ESD protection structure. (Topside contact)
2	Drain	Aluminum metallized manifold MOSFET Drain. (Topside contact)
3	Source	Chrome Gold metallized MOSFET Source contact. Appropriate electrical, mechanical and thermal connection required for proper operation. (Backside contact)

Pad Diagram

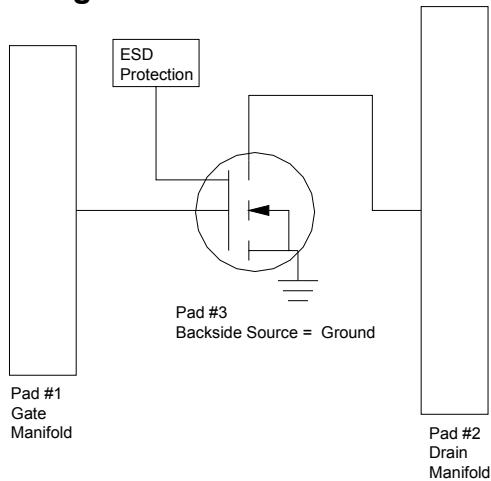

Note 1:

Gate voltage must be applied to the device concurrently or after application of drain voltage to prevent potentially destructive oscillations. Bias voltages should never be applied to the transistor unless it is properly terminated on both input and output.

Note 2:

The required V_{GS} corresponding to a specific I_{DQ} will vary from device to device due to the normal die-to-die variation in threshold voltage with LDMOS transistors.

Note 3:

The threshold voltage (V_{GSTH}) of LDMOS transistors varies with device temperature. External temperature compensation may be required. See Sirenza application notes AN-067 LDMOS Bias Temperature Compensation.

Absolute Maximum Ratings

Parameters	Value	Unit
Drain Voltage (V_{DS})	35	Volts
Gate Voltage (V_{GS}), $V_{DS} = 0$	20	Volts
RF Input Power	+30	dBm
Load Impedance for Continuous Operation Without Damage	10:1	VSWR
Output Device Channel Temperature	+200	°C
Storage Temperature Range	-40 to +150	°C

Operation of this device beyond any one of these limits may cause permanent damage. For reliable continuous operation see typical setup values specified in the table on page one.



Caution: ESD Sensitive

Appropriate precaution in handling, packaging and testing devices must be observed.

Impedance Data

Frequency (MHz)	Z _{source}	Z _{load}
880	2.7 + j 13.1	12.5 + j 22.5
960	1.9 + j 10.6	11.8 + j 18.3
1840	1.7 + j 3.4	1.0 + j 4.7
1960	1.3 + j 2.0	1.2 + j 5.7
2140	1.2 + j 0.7	1.7 + j 6.4

Impedances Referenced to Wirebond/PCB Interface.

De-embedding Information

Description	Gate	Drain
Number of Bond Wires	2	3
Length of Bond Wires	0.040	0.040
Height of Bond Wires	0.006	0.006
Pitch of Bond Wires	0.005	0.005
Bond Wire Diameter	0.002	0.002

All Dimensions in Inches.

Wirebond Heights Referenced to Top Surface of Die.

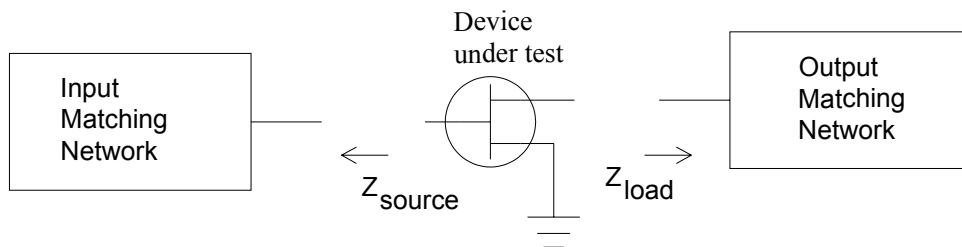
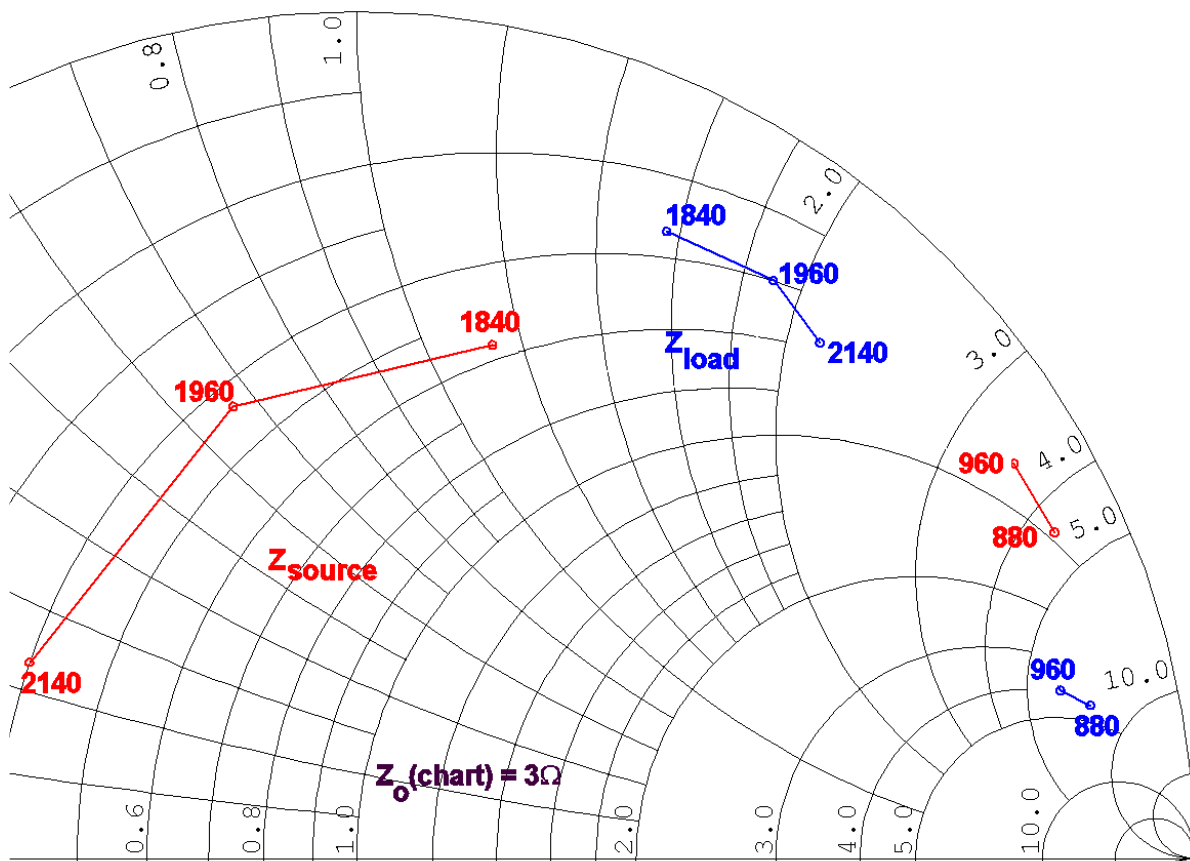

Z_{source} and Z_{load} are the optimal impedances presented to the SLD-1000 when operating at 28V, I_{dq}=30mA, P_{out}=3.5 W PEP.

Typical Performance Curves for packaged die tested in SLD-1083CZ 900 MHz Application Circuit

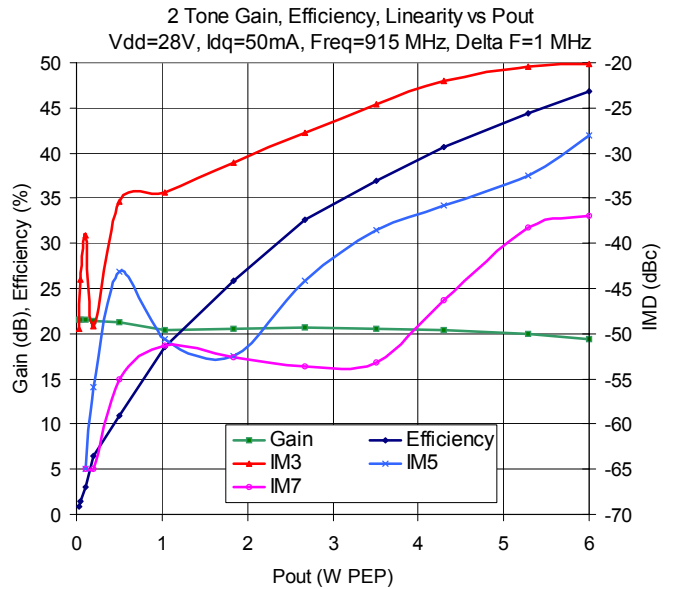
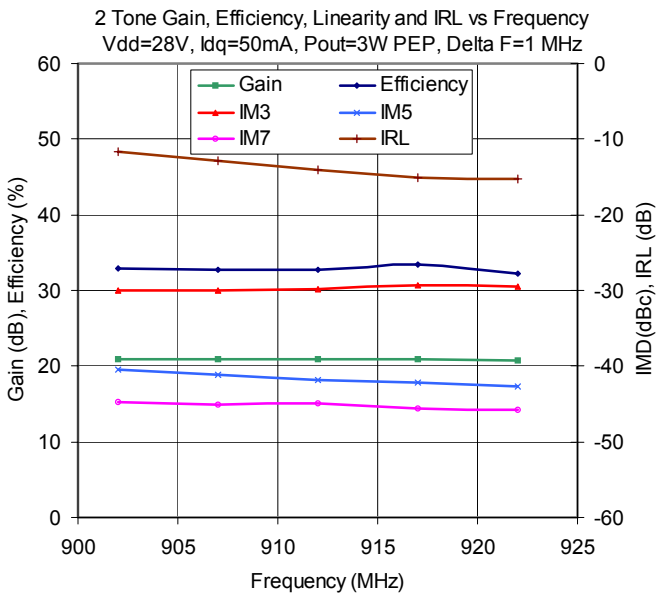
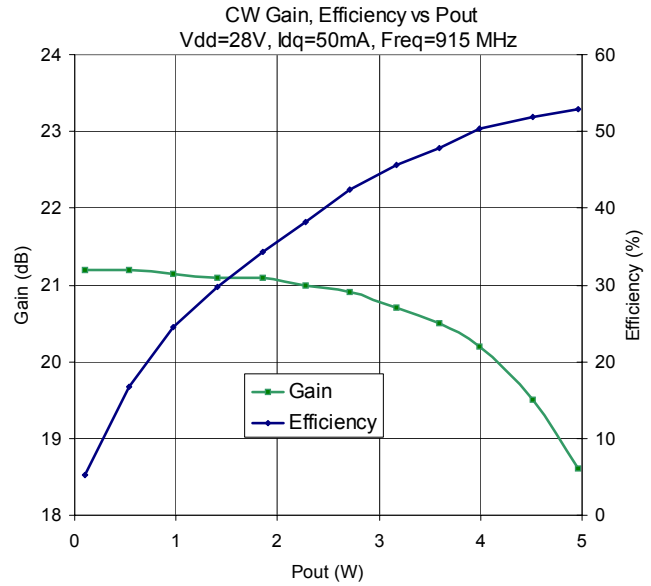
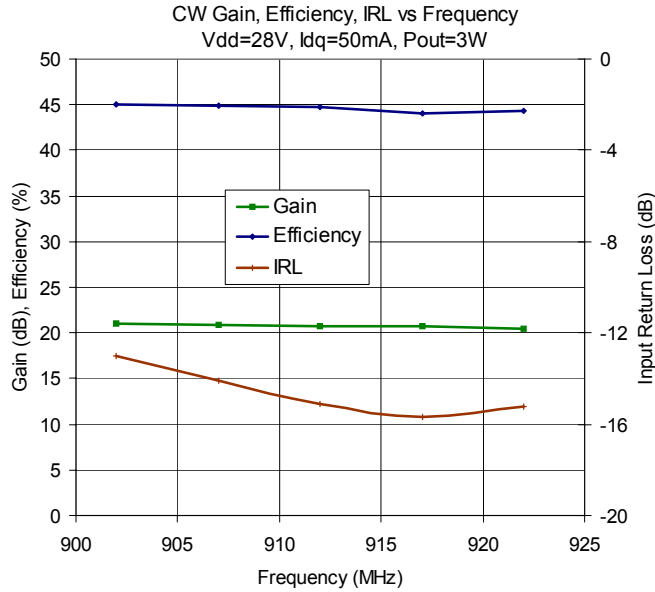

Die Map

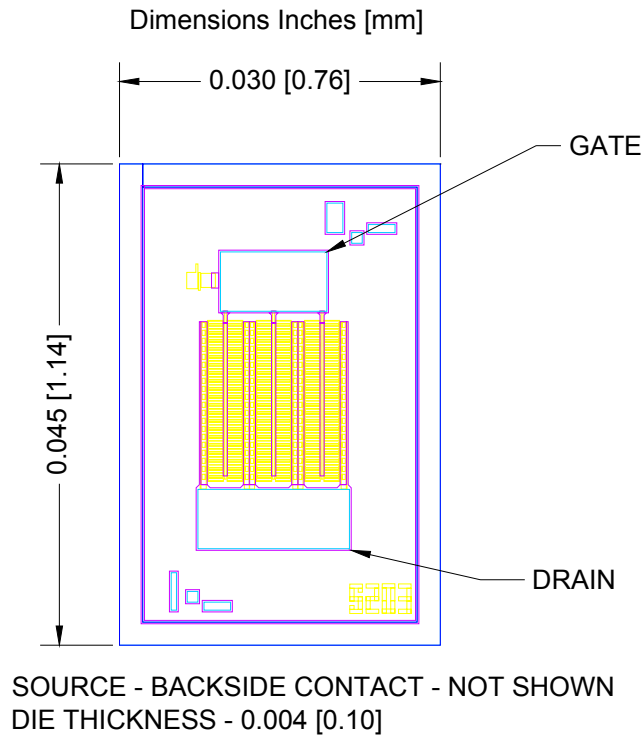

AuSi, AuSn, or AuGe eutectic die attach is recommended. AISi bond wires are recommended.

Part Number Ordering Information

Part Number	Gel Pack
SLD-1000	100 pcs. per pack

Die are screened prior to dicing to DC parameters and are shipped per Sirenza application note AN-039 Visual Criteria of Unpackaged Die.