

SEMITOP[®] 2

MOSFET Module

SK 85MH10

Preliminary Data

Features

- Compact design
- One screw mounting
- Heat transfer and isolation through direct copper bonding aluminium oxide ceramic (DBC)
- Trench-gate technology
- Short internal connections and low inductance case

Typical Applications

- Low switched mode power supplies
- DC servo drives
- UPS

1) Maximum PCB temperature, at pins contact, = 85°C

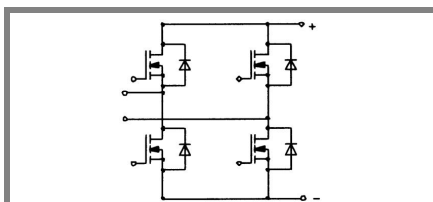

MH

Absolute Maximum Ratings		$T_s = 25\text{ °C}$, unless otherwise specified	
Symbol	Conditions	Values	Units
MOSFET			
V_{DSS}		100	V
V_{GSS}		± 20	V
I_D	$T_s = 25\text{ (80) °C}; 1)$	80 (60)	A
I_{DM}	$t_p < 1\text{ ms}; T_s = 80\text{ °C}; 1)$	120	A
T_j		- 40 ... + 150	°C
Inverse diode			
$I_F = - I_D$	$T_s = 25\text{ (80) °C};$	80 (60)	A
$I_{FM} = - I_{DM}$	$t_p < 1\text{ ms}; T_s = 80\text{ () °C};$	120	A
T_j		- 40 ... + 150	°C
Freewheeling CAL diode			
$I_F = - I_D$	$T_s = \text{°C}$		A
T_j			°C
T_{stg}		- 40 ... + 125	°C
T_{sol}	Terminals, 10 s	260	°C
V_{isol}	AC, 1 min (1s)	2500 / 3000	V

Characteristics		$T_s = 25\text{ °C}$, unless otherwise specified			
Symbol	Conditions	min.	typ.	max.	Units
MOSFET					
$V_{(BR)DSS}$	$V_{GS} = 0\text{ V}; I_D = 5,6\text{ mA}$	100			V
$V_{GS(th)}$	$V_{GS} = V_{DS}; I_D = 5,6\text{ mA}$	2,5	3,3		V
I_{DSS}	$V_{GS} = 0\text{ V}; V_{DS} = V_{DSS}; T_j = 25\text{ °C}$			100	μA
I_{GSS}	$V_{GS} = \pm 20\text{ V}; V_{DS} = 0\text{ V}$			100	nA
$R_{DS(on)}$	$I_D = 80\text{ A}; V_{GS} = 10\text{ V}; T_j = 25\text{ °C}$			7,5	m Ω
$R_{DS(on)}$	$I_D = 80\text{ A}; V_{GS} = 10\text{ V}; T_j = 125\text{ °C}$			13,5	m Ω
C_{CHC}	per MOSFET				pF
C_{iss}	under following conditions:		9,1		nF
C_{oss}	$V_{GS} = 0\text{ V}; V_{DS} = 25\text{ V}; f = 1\text{ MHz}$		1,8		nF
C_{rss}			1,6		nF
L_{DS}					nH
$t_{d(on)}$	under following conditions:		300		ns
t_r	$V_{DD} = 50\text{ V}; V_{GS} = 10\text{ V};$ $I_D = 50\text{ A}$		140		ns
$t_{d(off)}$	$R_G = 56\text{ }\Omega$		1550		ns
t_f			150		ns
$R_{th(j-s)}$	per MOSFET (per module)			1,1	K/W
Inverse diode					
V_{SD}	$I_F = 50\text{ A}; V_{GS} = 0\text{ V}; T_j = \text{°C}$		0,9		V
I_{RRM}	under following conditions:		24		A
Q_{rr}	$I_F = 50\text{ A}; T_{vj} = 25\text{ °C}; R_G = 56\text{ }\Omega$		0,9		μC
t_{rr}	$V_R = 65\text{ A}; di/dt = 100\text{ A}/\mu\text{s}$		70		ns
Free-wheeling diode					
V_F	$I_F = \text{A}; V_{GS} = \text{V}$				V
I_{RRM}	under following conditions:				A
Q_{rr}	$I_F = \text{A}; T_{vj} = \text{°C}$				μC
t_{rr}	$V_f = \text{A}; di/dt = \text{A}/\mu\text{s}$				ns
Mechanical data					
M1	mounting torque			2	Nm
w			20		g
Case			T 34		

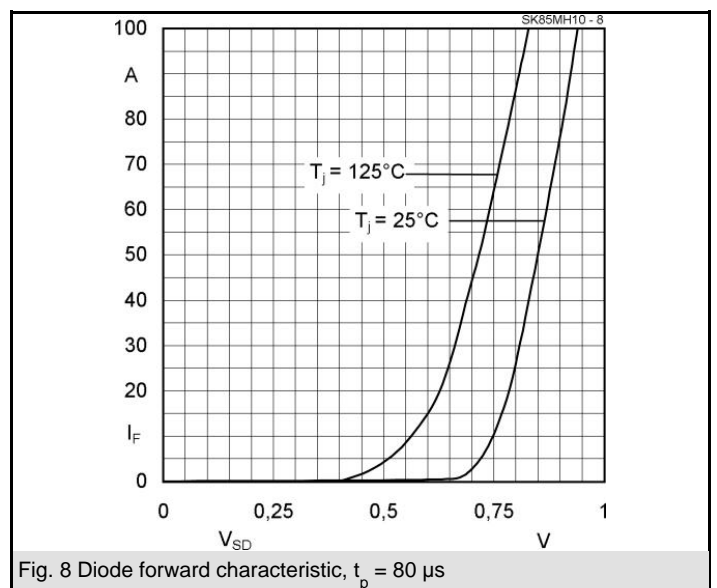
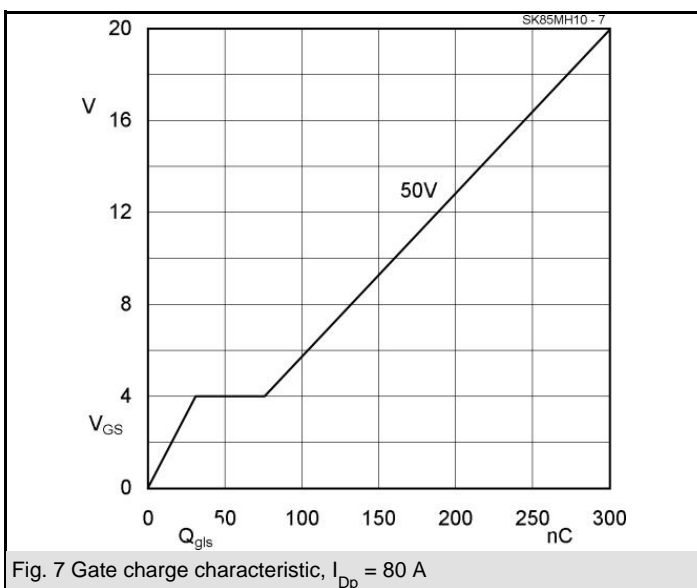
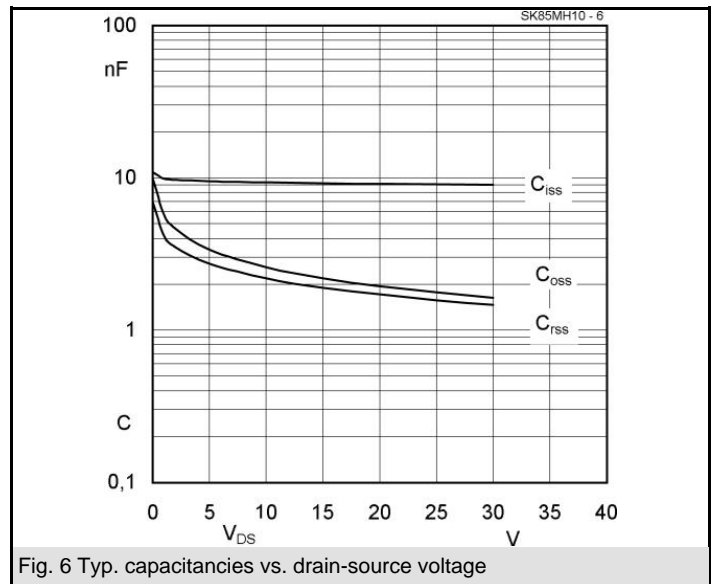
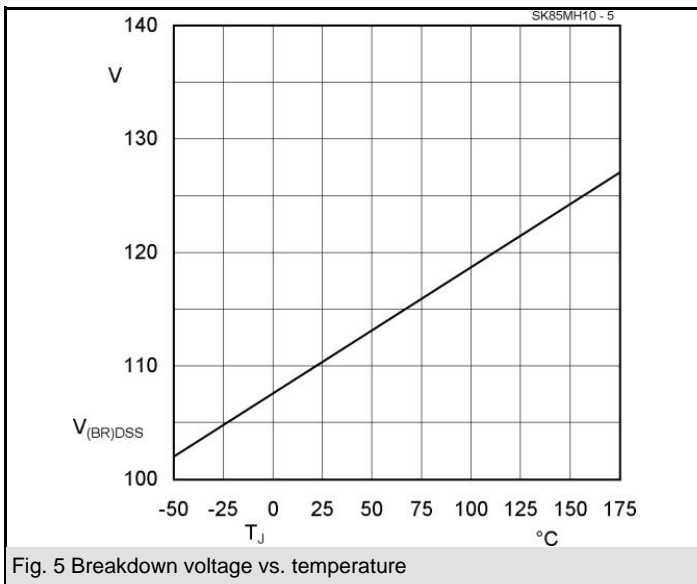
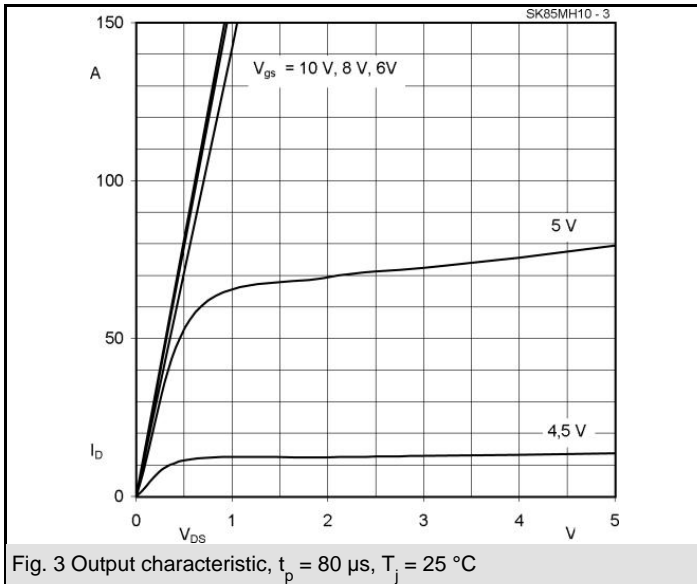

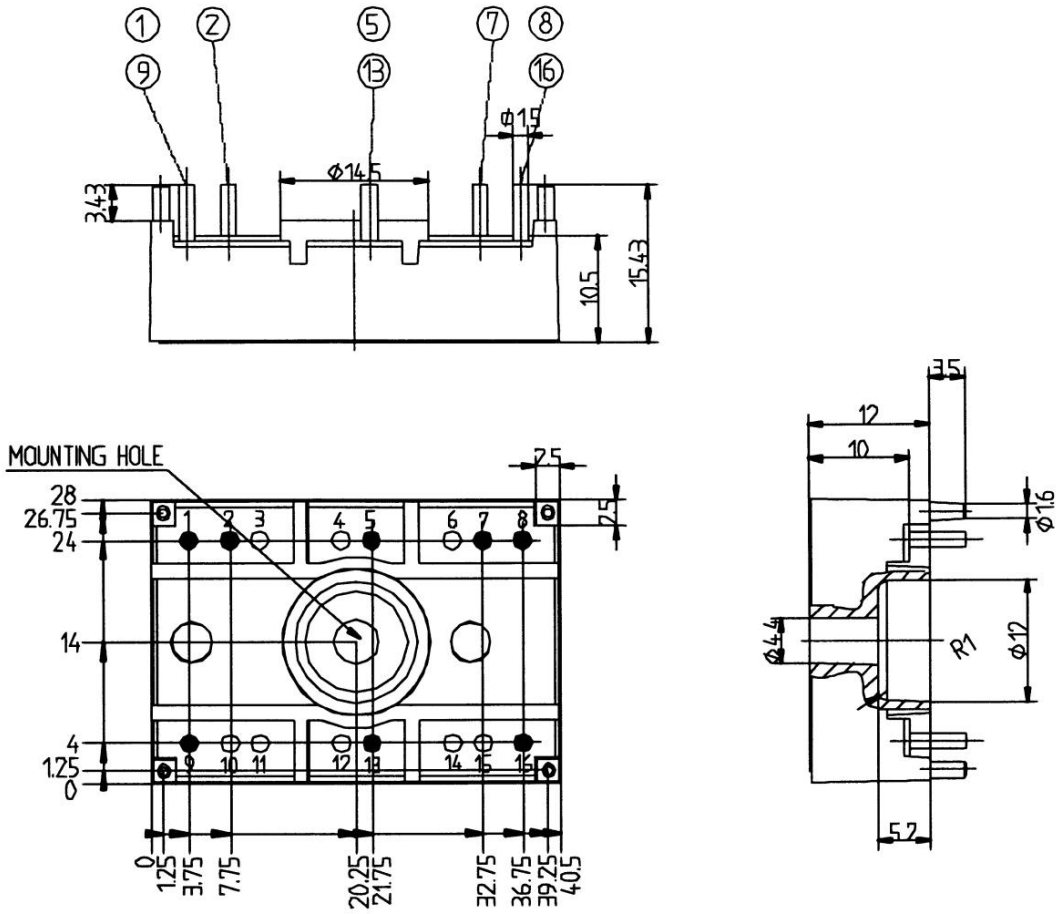

SUGGESTED HOLEDIAMETER FOR THE SOLDER PINS AND THE MOUNTING PINS IN THE PCB: 2 mm

Case T34

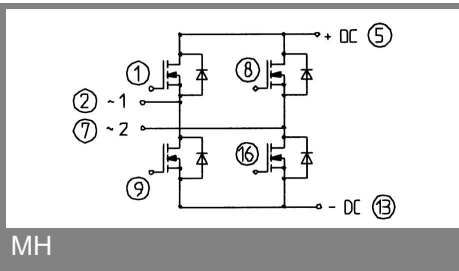

MH

This is an electrostatic discharge sensitive device (ESDS), international standard IEC 60747-1, Chapter IX.

This technical information specifies semiconductor devices but promises no characteristics. No warranty or guarantee expressed or implied is made regarding delivery, performance or suitability.