



P-Channel 12-V (D-S) MOSFET

PRODUCT SUMMARY		
V_{DS} (V)	$r_{DS(on)}$ (Ω)	I_D (A)
-12	0.0085 @ $V_{GS} = -4.5$ V	-9.5
	0.0106 @ $V_{GS} = -2.5$ V	-8.5
	0.014 @ $V_{GS} = -1.8$ V	-7.5

FEATURES

- TrenchFET® Power MOSFET

APPLICATIONS

- Load Switch

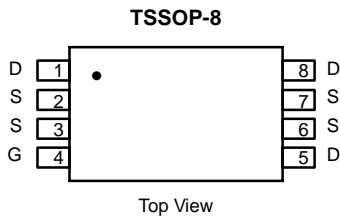

Ordering Information: Si6423DQ
Si6423DQ-T1 (with Tape and Reel)

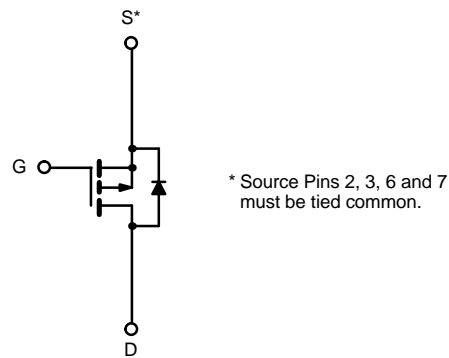

P-Channel MOSFET

ABSOLUTE MAXIMUM RATINGS ($T_A = 25^\circ\text{C}$ UNLESS OTHERWISE NOTED)					
Parameter		Symbol	10 secs	Steady State	Unit
Drain-Source Voltage		V_{DS}	-12		V
Gate-Source Voltage		V_{GS}	± 8		
Continuous Drain Current ($T_J = 150^\circ\text{C}$) ^a	$T_A = 25^\circ\text{C}$	I_D	-9.5	-8.2	A
	$T_A = 70^\circ\text{C}$		-8	-6.5	
Pulsed Drain Current (10 μs Pulse Width)		I_{DM}	-30		
Continuous Source Current (Diode Conduction) ^a		I_S	-1.35	-0.95	W
Maximum Power Dissipation ^a	$T_A = 25^\circ\text{C}$	P_D	1.5	1.05	
	$T_A = 70^\circ\text{C}$		1.0	0.67	
Operating Junction and Storage Temperature Range		T_J, T_{stg}	-55 to 150		$^\circ\text{C}$

THERMAL RESISTANCE RATINGS					
Parameter		Symbol	Typical	Maximum	Unit
Maximum Junction-to-Ambient ^a	$t \leq 10$ sec	R_{thJA}	60	83	$^\circ\text{C/W}$
	Steady State		100	120	
Maximum Junction-to-Foot	Steady State	R_{thJF}	35	45	

Notes

a. Surface Mounted on 1" x 1" FR4 Board.

SPECIFICATIONS (T_J = 25 °C UNLESS OTHERWISE NOTED)

Parameter	Symbol	Test Condition	Min	Typ	Max	Unit
Static						
Gate Threshold Voltage	V _{GS(th)}	V _{DS} = V _{GS} , I _D = -400 μA	-0.40		-0.8	V
Gate-Body Leakage	I _{GSS}	V _{DS} = 0 V, V _{GS} = ±8 V			±100	nA
Zero Gate Voltage Drain Current	I _{DSS}	V _{DS} = -9.6 V, V _{GS} = 0 V			-1	μA
		V _{DS} = -9.6 V, V _{GS} = 0 V, T _J = 70 °C			-10	
On-State Drain Current ^a	I _{D(on)}	V _{DS} = -5 V, V _{GS} = -4.5 V	-20			A
Drain-Source On-State Resistance ^a	r _{DS(on)}	V _{GS} = -4.5 V, I _D = -9.5 A		0.0068	0.0085	Ω
		V _{GS} = -2.5 V, I _D = -8.5 A		0.0085	0.0106	
		V _{GS} = -1.8 V, I _D = -7.5 A		0.0112	0.014	
Forward Transconductance ^a	g _{fs}	V _{DS} = -15 V, I _D = -9.5 A		45		S
Diode Forward Voltage ^a	V _{SD}	I _S = -1.3 A, V _{GS} = 0 V		-0.58	-1.1	V
Dynamic^b						
Total Gate Charge	Q _g	V _{DS} = -6 V, V _{GS} = -5 V, I _D = -9.5 A		74	110	nC
Gate-Source Charge	Q _{gs}			9.0		
Gate-Drain Charge	Q _{gd}			19		
Gate Resistance	R _g			3.6		Ω
Turn-On Delay Time	t _{d(on)}	V _{DD} = -6 V, R _L = 6 Ω I _D ≅ -1 A, V _{GEN} = -4.5 V, R _G = 6 Ω		50	75	ns
Rise Time	t _r			75	110	
Turn-Off Delay Time	t _{d(off)}			270	400	
Fall Time	t _f			200	300	
Source-Drain Reverse Recovery Time	t _{rr}	I _F = -1.3 A, di/dt = 100 A/μs		160	250	

Notes

- a. Pulse test; pulse width ≤ 300 μs, duty cycle ≤ 2%.
b. Guaranteed by design, not subject to production testing.

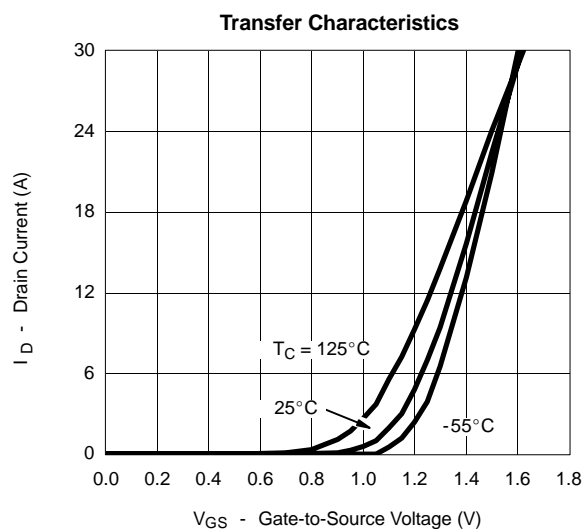
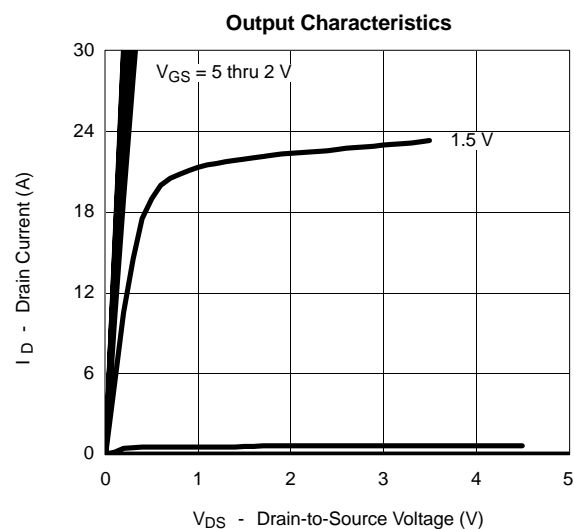
TYPICAL CHARACTERISTICS (25 °C UNLESS NOTED)



TYPICAL CHARACTERISTICS (25°C UNLESS NOTED)

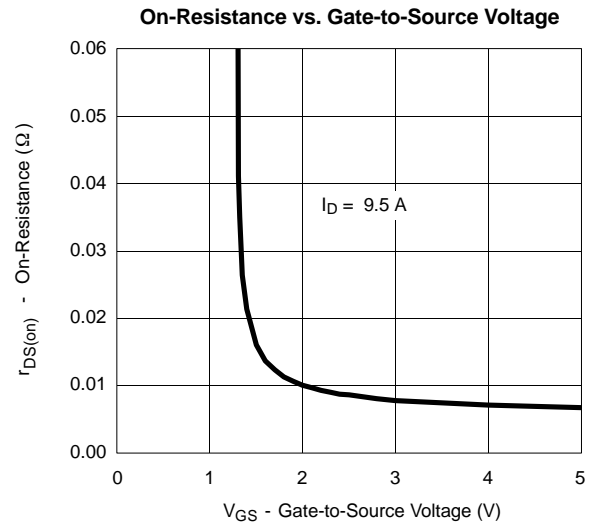
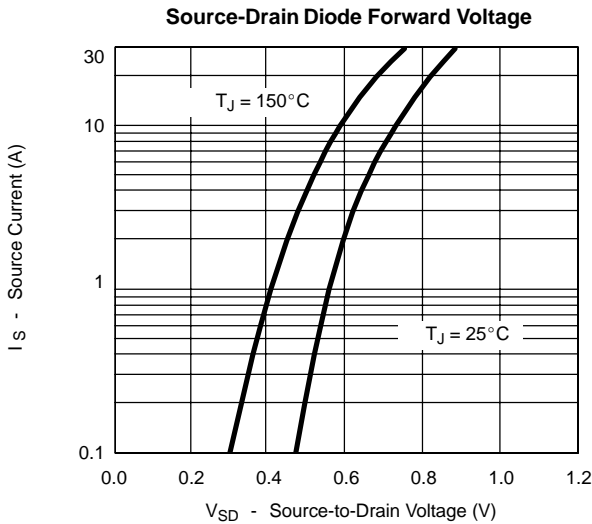
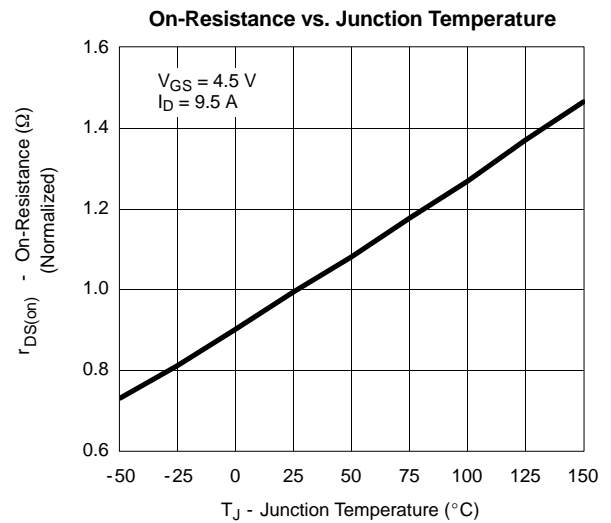
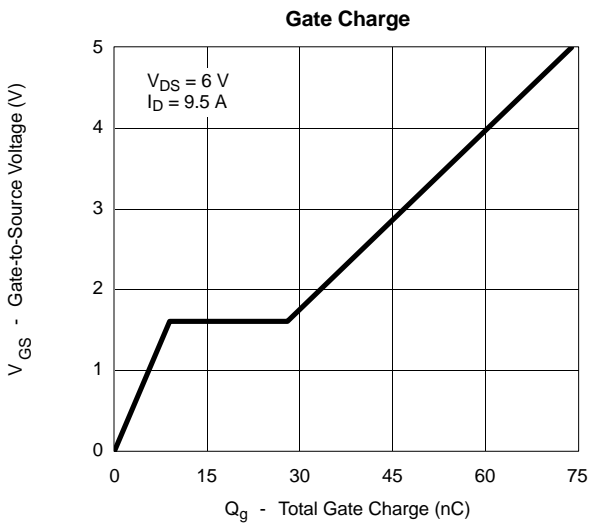
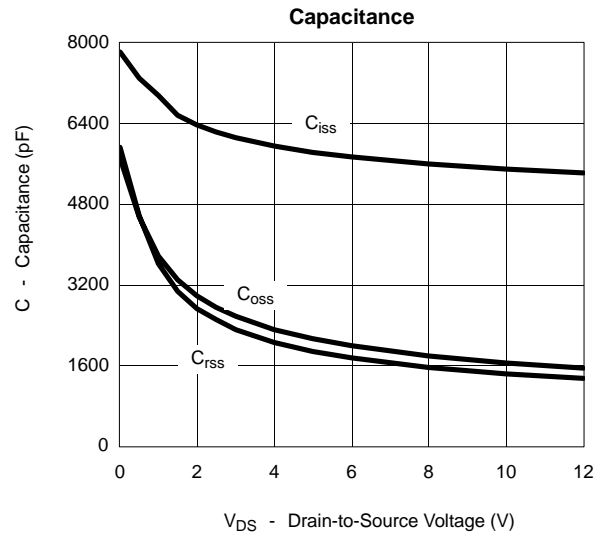
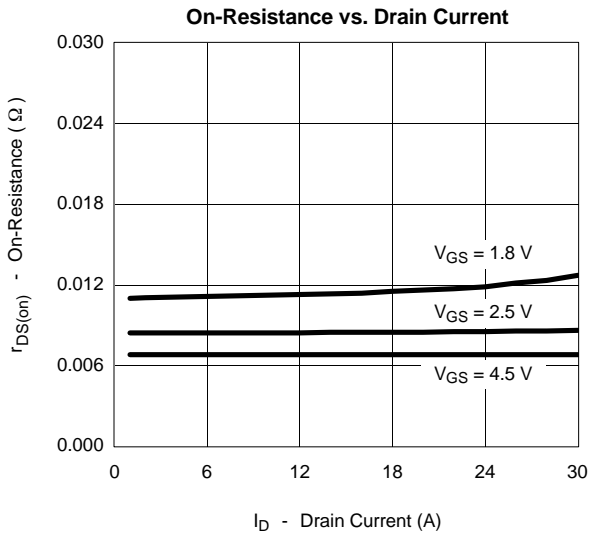

TYPICAL CHARACTERISTICS (25 °C UNLESS NOTED)

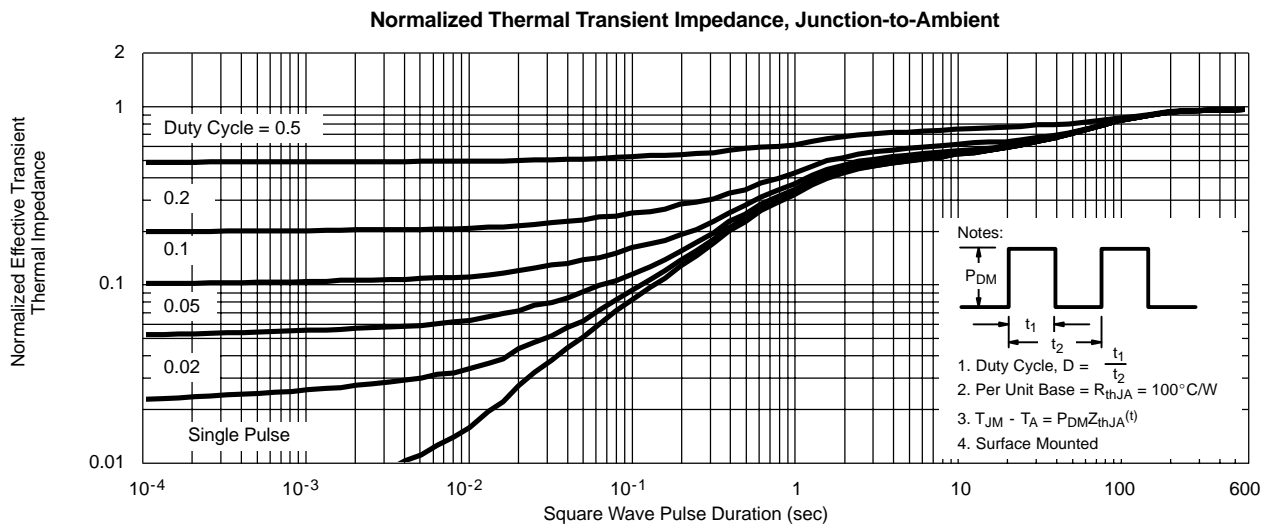
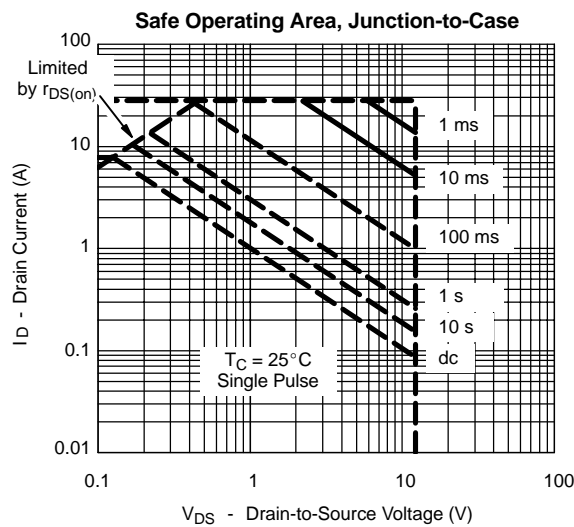
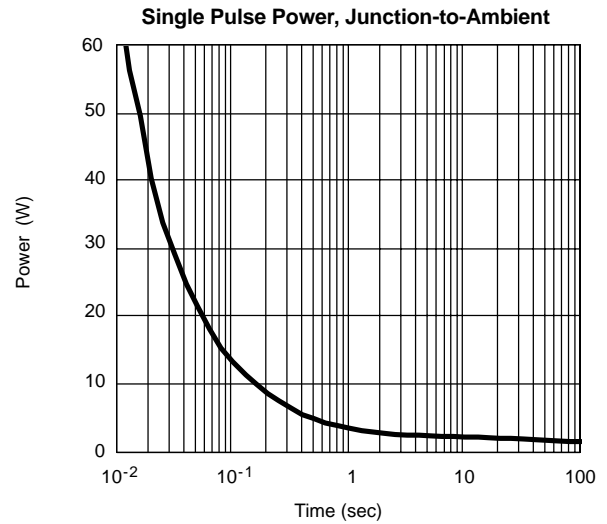
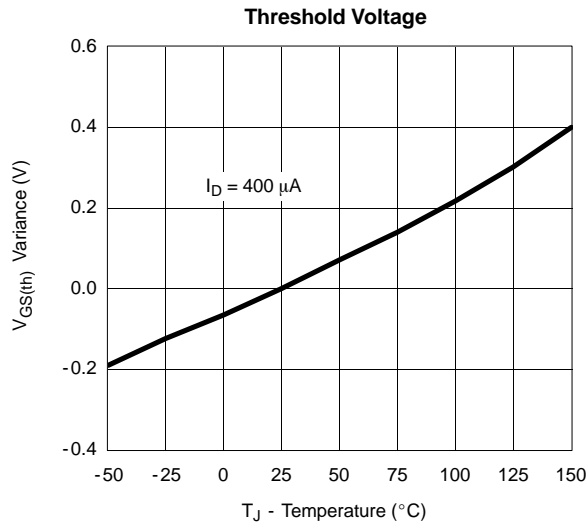



TYPICAL CHARACTERISTICS (25°C UNLESS NOTED)

