



## N-Channel 30-V (D-S) MOSFET

PRODUCT SUMMARY		
$V_{DS}$ (V)	$r_{DS(on)}$ ( $\Omega$ )	$I_D$ (A)
30	0.009 @ $V_{GS} = 10$ V	11
	0.010 @ $V_{GS} = 4.5$ V	10
	0.014 @ $V_{GS} = 2.5$ V	8.8

### FEATURES

- TrenchFET® Power MOSFETS: 2.5-V Rated
- 30-V  $V_{DS}$

### APPLICATIONS

- Battery Switch
- Charger Switch

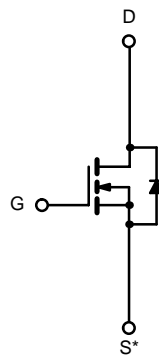
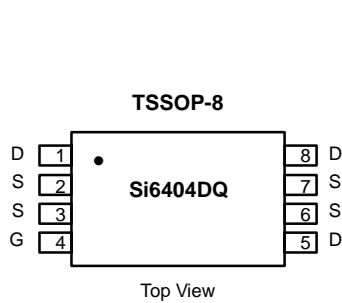

\* Source Pins 2, 3, 6 and 7 must be tied common.

N-Channel MOSFET

ABSOLUTE MAXIMUM RATINGS ( $T_A = 25^\circ\text{C}$ UNLESS OTHERWISE NOTED)					
Parameter		Symbol	10 secs	Steady State	Unit
Drain-Source Voltage		$V_{DS}$	30		V
Gate-Source Voltage		$V_{GS}$	$\pm 12$		
Continuous Drain Current ( $T_J = 150^\circ\text{C}$ ) <sup>a</sup>	$T_A = 25^\circ\text{C}$	$I_D$	11	8.6	A
	$T_A = 70^\circ\text{C}$		8.9	6.9	
Pulsed Drain Current (10 $\mu\text{s}$ Pulse Width)		$I_{DM}$	30		
Continuous Source Current (Diode Conduction) <sup>a</sup>		$I_S$	1.5	0.95	W
Maximum Power Dissipation <sup>a</sup>	$T_A = 25^\circ\text{C}$	$P_D$	1.75	1.08	
	$T_A = 70^\circ\text{C}$		1.14	0.69	
Operating Junction and Storage Temperature Range		$T_J, T_{stg}$	-55 to 150		$^\circ\text{C}$

THERMAL RESISTANCE RATINGS					
Parameter		Symbol	Typical	Maximum	Unit
Maximum Junction-to-Ambient <sup>a</sup>	$t \leq 10$ sec	$R_{thJA}$	55	70	$^\circ\text{C/W}$
	Steady State		95	115	
Maximum Junction-to-Foot (Drain)	Steady State	$R_{thJF}$	35	45	

Notes

a. Surface Mounted on 1" x 1" FR4 Board.

**SPECIFICATIONS (T<sub>J</sub> = 25 °C UNLESS OTHERWISE NOTED)**

Parameter	Symbol	Test Condition	Min	Typ	Max	Unit
<b>Static</b>						
Gate Threshold Voltage	V <sub>GS(th)</sub>	V <sub>DS</sub> = V <sub>GS</sub> , I <sub>D</sub> = 250 μA	0.6			V
Gate-Body Leakage	I <sub>GSS</sub>	V <sub>DS</sub> = 0 V, V <sub>GS</sub> = ±12 V			±100	nA
Zero Gate Voltage Drain Current	I <sub>DSS</sub>	V <sub>DS</sub> = 24 V, V <sub>GS</sub> = 0 V			1	μA
		V <sub>DS</sub> = 24 V, V <sub>GS</sub> = 0 V, T <sub>J</sub> = 70 °C			10	
On-State Drain Current <sup>a</sup>	I <sub>D(on)</sub>	V <sub>DS</sub> = 5 V, V <sub>GS</sub> = 10 V	20			A
Drain-Source On-State Resistance <sup>a</sup>	r <sub>DS(on)</sub>	V <sub>GS</sub> = 10 V, I <sub>D</sub> = 11 A		0.0073	0.009	Ω
		V <sub>GS</sub> = 4.5 V, I <sub>D</sub> = 10 A		0.0084	0.010	
		V <sub>GS</sub> = 2.5 V, I <sub>D</sub> = 8.8 A		0.0116	0.014	
Forward Transconductance <sup>a</sup>	g <sub>fs</sub>	V <sub>DS</sub> = 10 V, I <sub>D</sub> = 11 A		27		S
Diode Forward Voltage <sup>a</sup>	V <sub>SD</sub>	I <sub>S</sub> = 1.5 A, V <sub>GS</sub> = 0 V		0.72	1.1	V
<b>Dynamic<sup>b</sup></b>						
Total Gate Charge	Q <sub>g</sub>	V <sub>DS</sub> = 15 V, V <sub>GS</sub> = 4.5 V, I <sub>D</sub> = 11 A		32	48	nC
Gate-Source Charge	Q <sub>gs</sub>			8.1		
Gate-Drain Charge	Q <sub>gd</sub>			10		
Gate Resistance	R <sub>g</sub>			7.5		Ω
Turn-On Delay Time	t <sub>d(on)</sub>	V <sub>DD</sub> = 15 V, R <sub>L</sub> = 15 Ω I <sub>D</sub> ≅ 1 A, V <sub>GEN</sub> = 4.5 V, R <sub>G</sub> = 6 Ω		35	55	ns
Rise Time	t <sub>r</sub>			35	55	
Turn-Off Delay Time	t <sub>d(off)</sub>			100	150	
Fall Time	t <sub>f</sub>			50	75	
Source-Drain Reverse Recovery Time	t <sub>rr</sub>		I <sub>F</sub> = 1.5 A, di/dt = 100 A/μs		40	

## Notes

- a. Pulse test; pulse width ≤ 300 μs, duty cycle ≤ 2%.  
b. Guaranteed by design, not subject to production testing.

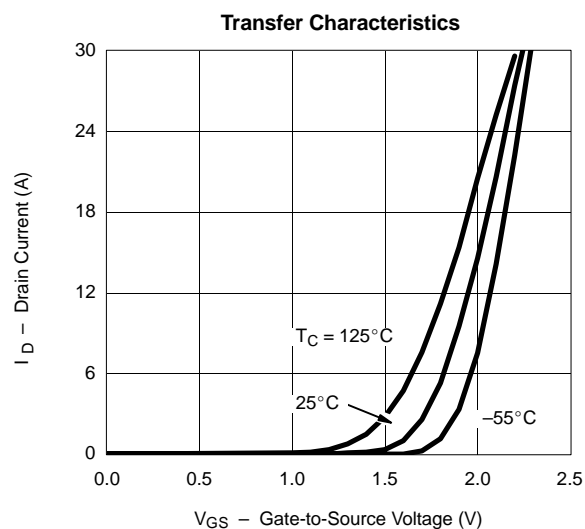
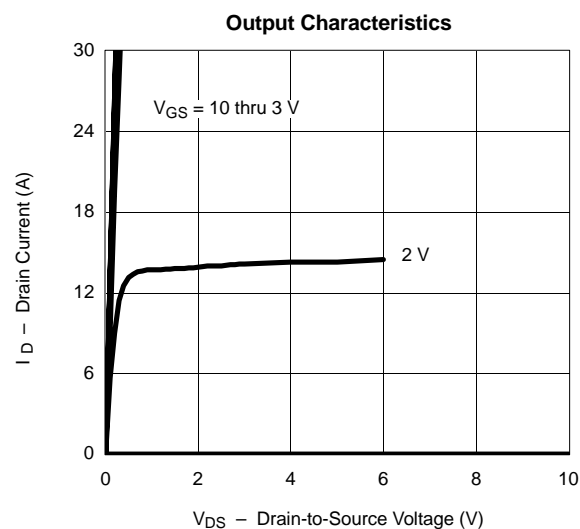
**TYPICAL CHARACTERISTICS (25 °C UNLESS NOTED)**



**TYPICAL CHARACTERISTICS (25 °C UNLESS NOTED)**

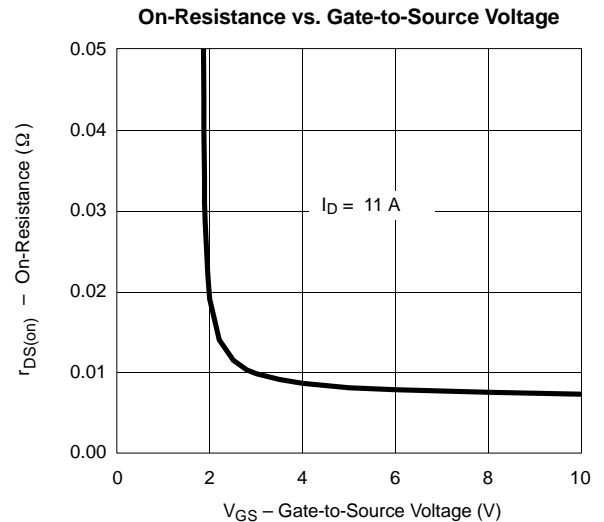
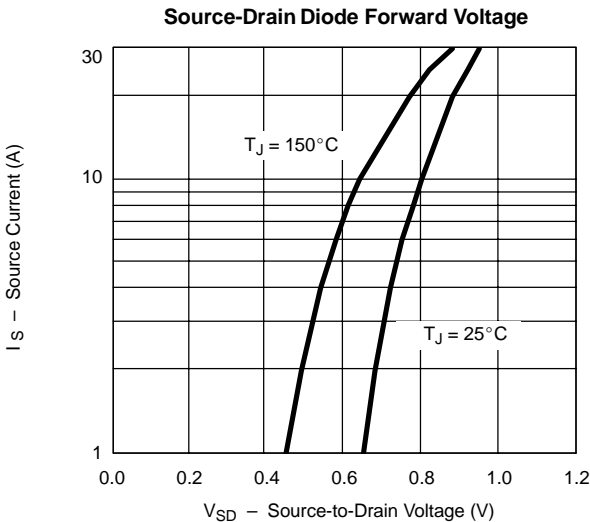
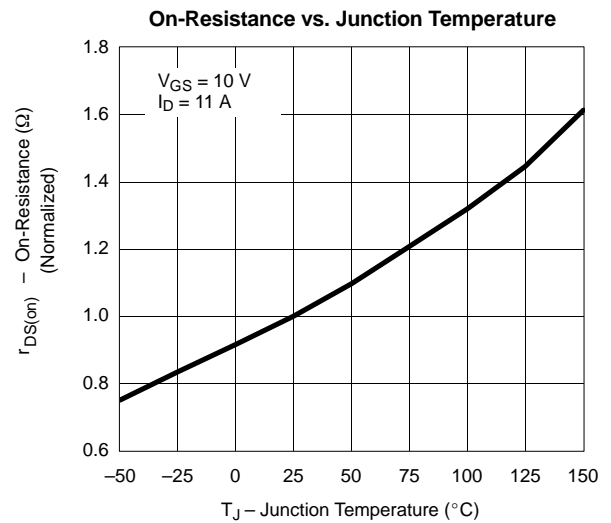
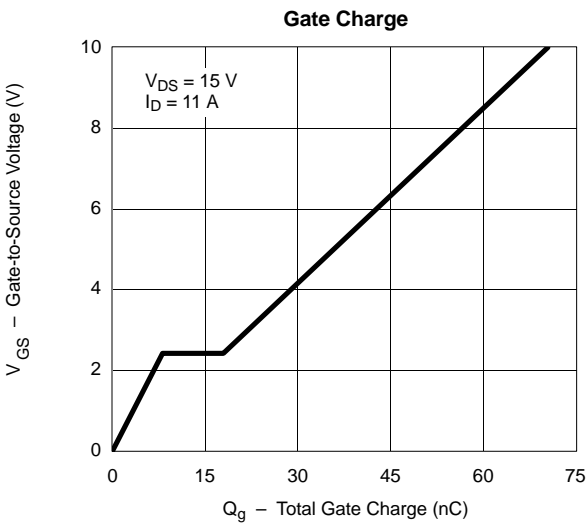
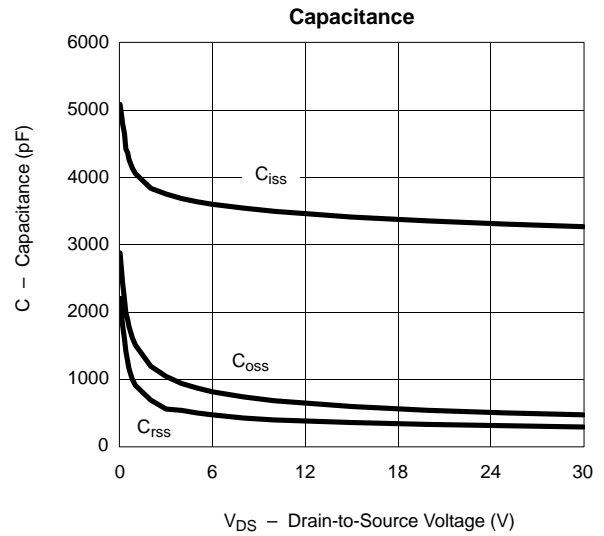
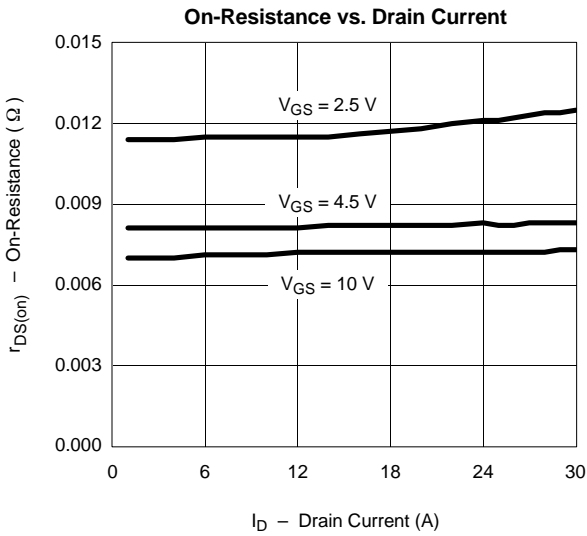

**TYPICAL CHARACTERISTICS (25 °C UNLESS NOTED)**

