



P-Channel 12-V (D-S) MOSFET

CHARACTERISTICS

- P-Channel Vertical DMOS
- Macro Model (Subcircuit Model)
- Level 3 MOS
- Apply for both Linear and Switching Application
- Accurate over the -55 to 125°C Temperature Range
- Model the Gate Charge, Transient, and Diode Reverse Recovery Characteristics

DESCRIPTION

The attached spice model describes the typical electrical characteristics of the p-channel vertical DMOS. The subcircuit model is extracted and optimized over the -55 to 125°C temperature ranges under the pulsed 0-V to 5-V gate drive. The saturated output impedance is best fit at the gate bias near the threshold voltage.

A novel gate-to-drain feedback capacitance network is used to model the gate charge characteristics while avoiding convergence difficulties of the switched C_{gd} model. All model parameter values are optimized to provide a best fit to the measured electrical data and are not intended as an exact physical interpretation of the device.

SUBCIRCUIT MODEL SCHEMATIC

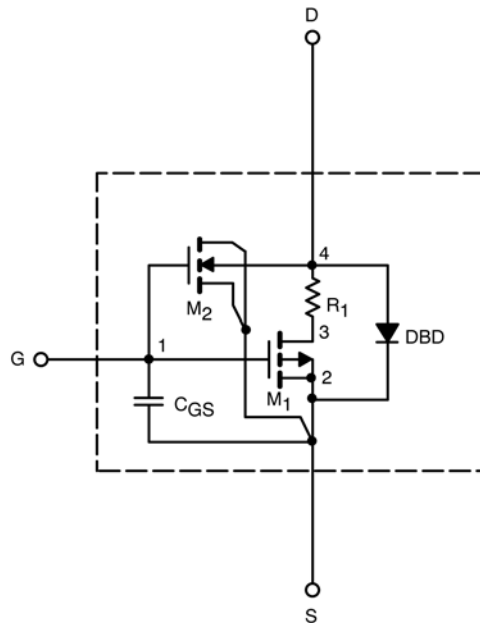

This document is intended as a SPICE modeling guideline and does not constitute a commercial product data sheet. Designers should refer to the appropriate data sheet of the same number for guaranteed specification limits.



SPECIFICATIONS (T _J = 25°C UNLESS OTHERWISE NOTED)					
Parameter	Symbol	Test Condition	Simulated Data	Measured Data	Unit
Static					
Gate Threshold Voltage	V _{GS(th)}	V _{DS} = V _{GS} , I _D = -250 μA	0.70		V
On-State Drain Current ^a	I _{D(on)}	V _{DS} ≤ -5 V, V _{GS} = -4.5 V	116		A
Drain-Source On-State Resistance ^a	r _{DS(on)}	V _{GS} = -4.5 V, I _D = -5.3 A	0.023	0.025	Ω
		V _{GS} = -2.5 V, I _D = -4.6 A	0.034	0.033	
		V _{GS} = -1.8 V, I _D = -2 A	0.049	0.046	
Forward Transconductance ^a	g _{fs}	V _{DS} = -5 V, I _D = -5.3 A	17	17	S
Diode Forward Voltage ^a	V _{SD}	I _S = -1 A, V _{GS} = 0 V	-0.78	-0.70	V
Dynamic^b					
Total Gate Charge	Q _g	V _{DS} = -6 V, V _{GS} = -4.5 V, I _D = -5.3 A	9.3	11.5	nC
Gate-Source Charge	Q _{gs}		1.5	1.5	
Gate-Drain Charge	Q _{gd}		3.2	3.2	
Turn-On Delay Time	t _{d(on)}	V _{DD} = -6 V, R _L = 6 Ω I _D ≅ -1 A, V _{GEN} = -4.5 V, R _G = 6 Ω	21	25	ns
Rise Time	t _r		19	45	
Turn-Off Delay Time	t _{d(off)}		73	72	
Fall Time	t _f		15	60	

Notes

- a. Pulse test; pulse width ≤ 300 μs, duty cycle ≤ 2%.
- b. Guaranteed by design, not subject to production testing.



SPICE Device Model Si2333DS

Vishay Siliconix

COMPARISON OF MODEL WITH MEASURED DATA ($T_J=25^\circ\text{C}$ UNLESS OTHERWISE NOTED)

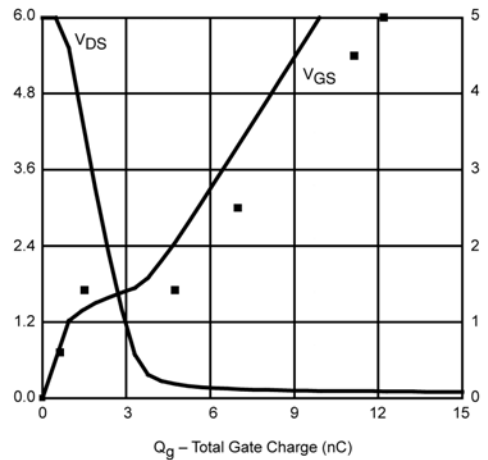
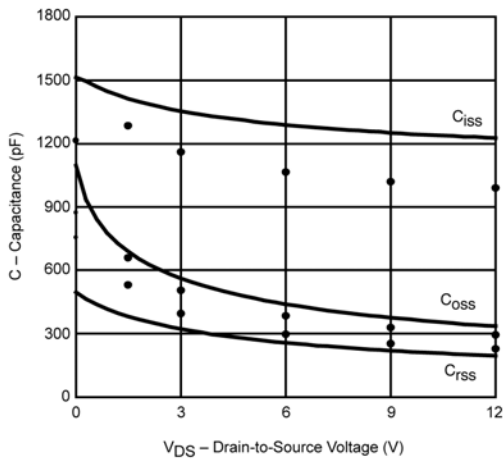
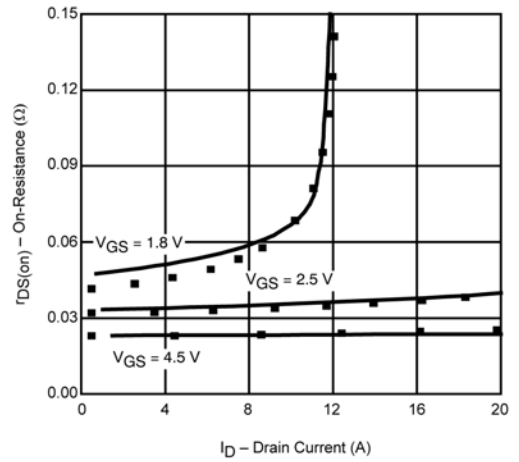
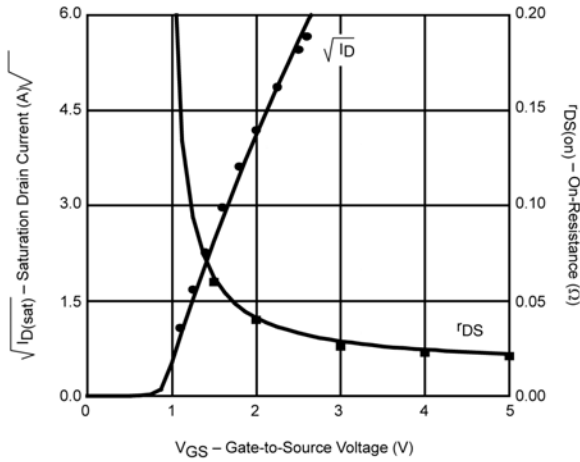
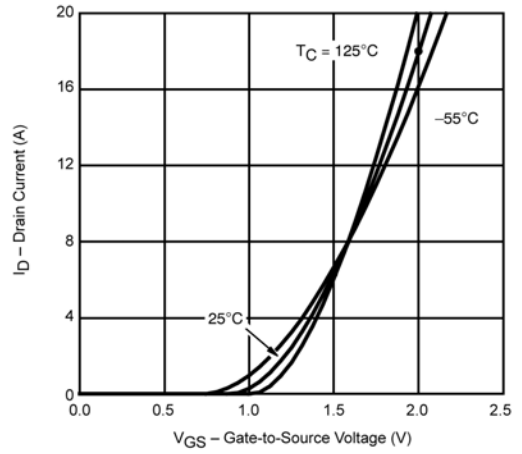
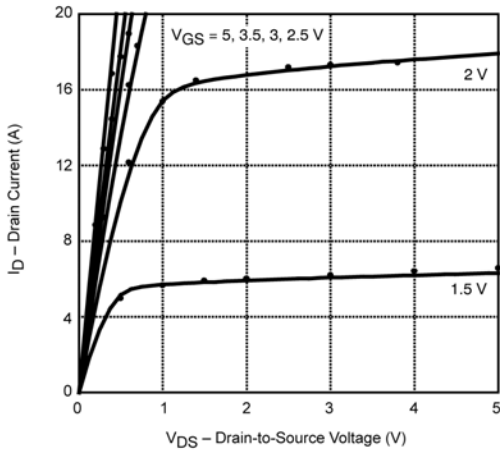

Note: Dots and squares represent measured data.