

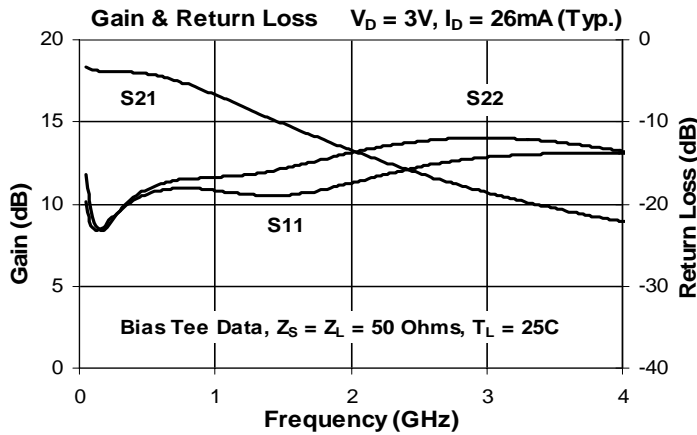

Product Description

Sirenza Microdevices' SGC-2363Z is a high performance SiGe HBT MMIC amplifier utilizing a Darlington configuration with a patented active-bias network. The active bias network provides stable current over temperature and process Beta variations. Designed to run directly from a 3V supply, the SGC-2363Z does not require a dropping resistor as compared to typical Darlington amplifiers. The SGC-2363Z is designed for high linearity 3V gain block applications that require small size and minimal external components. It is internally matched to 50 ohms.

The matte tin finish on Sirenza's lead-free "Z" package is applied using a post annealing process to mitigate tin whisker formation and is RoHS compliant per EU Directive 2002/95. The package body is manufactured with green molding compounds that contain no antimony trioxide or halogenated fire retardants.



Preliminary Information

SGC-2363Z



50-4000 MHz Silicon Germanium Cascadable Gain Block



Product Features

- Single Fixed 3V Supply
- Supply Dropping Resistor not required
- Patented Self-Bias Circuitry
- P1dB = 9.8 dBm at 1950 MHz
- IP3 = 23.5 dBm at 1950 MHz
- Robust 1000V ESD, Class 1C HBM

Applications

- PA Driver Amplifier
- Cellular, PCS, GSM, UMTS
- IF Amplifier
- Wireless Data, Satellite

Symbol	Parameters	Units	Frequency	Min.	Typ.	Max.
G	Small Signal Gain	dB	850 MHz 1950 MHz 2400 MHz		17.4 13.6 12.3	
P _{1dB}	Output Power at 1dB Compression	dBm	850 MHz 1950 MHz 2400 MHz		10.4 9.8 9.6	
OIP ₃	Output Third Order Intercept Point	dBm	850 MHz 1950 MHz 2400 MHz		22.9 23.5 23.8	
IRL	Input Return Loss	dB	1950 MHz		17.9	
ORL	Output Return Loss	dB	1950 MHz		14.3	
NF	Noise Figure	dB	1930 MHz		3.7	
V _D	Device Operating Voltage	V			3	
I _D	Device Operating Current	mA		22	26	30
R _{th, j-l}	Thermal Resistance (junction to lead)	°C/W			255	
Test Conditions: $V_D = 3.0V$ $I_D = 26mA \text{ Typ.}$ $T_L = 25^\circ C$ OIP ₃ Tone Spacing = 1MHz						
Bias Tee Data $Z_S = Z_L = 50 \text{ Ohms}$ Pout per tone = -5 dBm						

The information provided herein is believed to be reliable at press time. Sirenza Microdevices assumes no responsibility for inaccuracies or omissions. Sirenza Microdevices assumes no responsibility for the use of this information, and all such information shall be entirely at the user's own risk. Prices and specifications are subject to change without notice. No patent rights or licenses to any of the circuits described herein are implied or granted to any third party. Sirenza Microdevices does not authorize or warrant any Sirenza Microdevices product for use in life-support devices and/or systems. Copyright 2005 Sirenza Microdevices, Inc.. All worldwide rights reserved.

Typical RF Performance at Key Operating Frequencies (Bias Tee)

Symbol	Parameter	Unit	Frequency (MHz)					
			100	500	850	1950	2400	3500
G	Small Signal Gain	dB	18.4	18.1	17.4	13.6	12.3	9.8
OIP ₃	Output Third Order Intercept Point	dBm		23.3	22.9	23.5	23.8	22.1
P _{1dB}	Output Power at 1dB Compression	dBm		11.0	10.4	9.8	9.6	8.3
IRL	Input Return Loss	dB	23.6	19.0	18.0	17.9	16.3	14.2
ORL	Output Return Loss	dB	22.4	18.4	16.7	14.3	13.0	12.5
S ₁₂	Reverse Isolation	dB	20.5	21.6	22.2	20.5	19.9	18.9
NF	Noise Figure	dB	2.9	3.0	3.3	3.7	3.9	4.7

Test Conditions: V_D = 3V I_D = 26mA Typ. OIP₃ Tone Spacing = 1MHz, Pout per tone = -5 dBm
T_L = 25°C Z_S = Z_L = 50 Ohms

Typical Performance with Bias Tee, V_D = 3V, I_D = 26mA (Typ.)

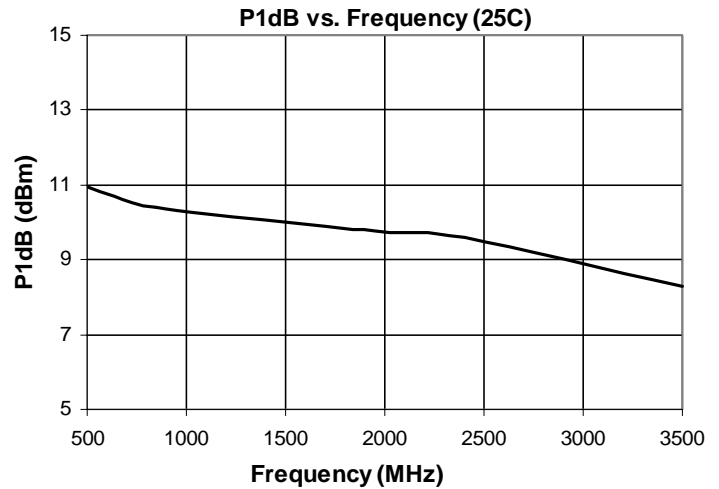
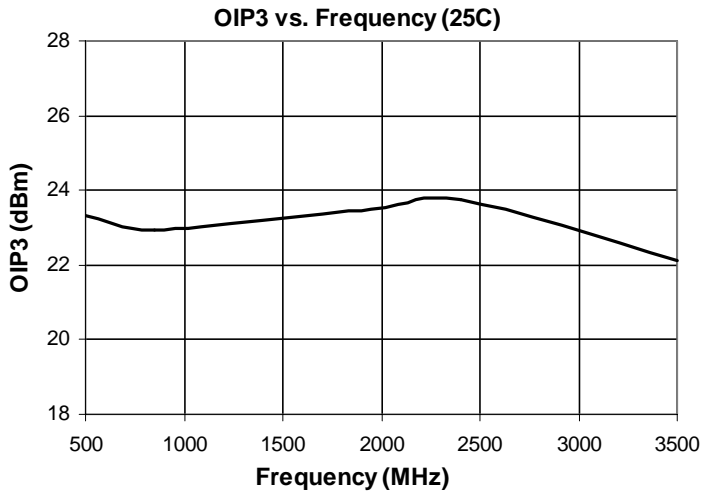

Absolute Maximum Ratings

Parameter	Absolute Limit
Max Device Current (I _{CE})	55 mA
Max Device Voltage (V _{CE})	4.5 V
Max. RF Input Power* (See Note)	+18 dBm
Max. Junction Temp. (T _J)	+150°C
Operating Temp. Range (T _L)	-40°C to +85°C
Max. Storage Temp.	+150°C

*Note: Load condition, Z_L = 50 Ohms

Operation of this device beyond any one of these limits may cause permanent damage. For reliable continuous operation, the device voltage and current must not exceed the maximum operating values specified in the table on page one.

Bias Conditions should also satisfy the following expression:

$$I_D V_D < (T_J - T_L) / R_{TH}, \text{ J} \quad T_L = T_{LEAD}$$

Reliability & Qualification Information

Parameter	Rating
ESD Rating - Human Body Model (HBM)	Class 1C
Moisture Sensitivity Level	MSL 1

This product qualification report can be downloaded at
www.sirenza.com



Caution: ESD sensitive

Appropriate precautions in handling, packaging and testing devices must be observed.

Typical Performance with Bias Tee, $V_D = 3V$, $I_D = 26mA$ (Typ.)

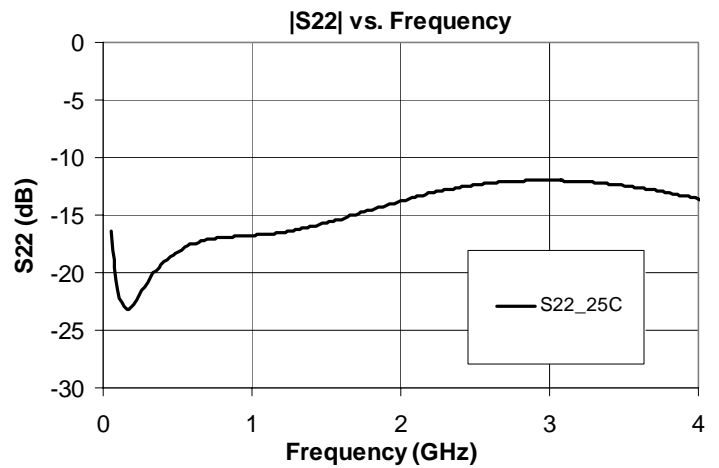
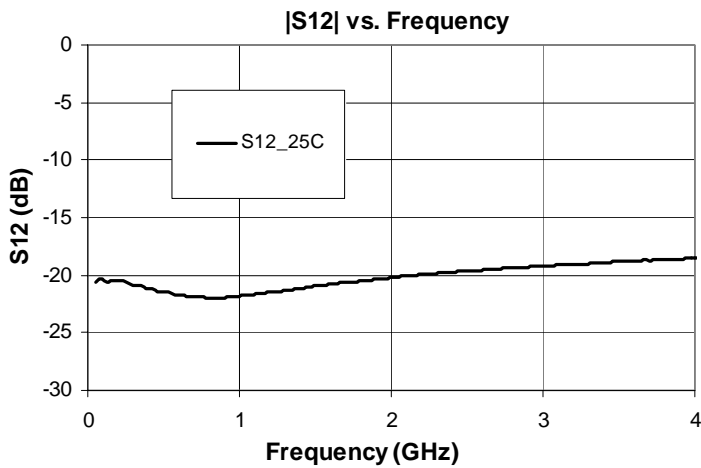
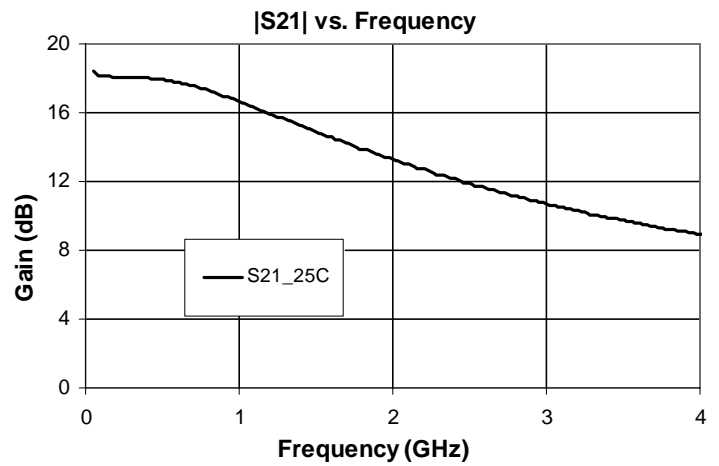
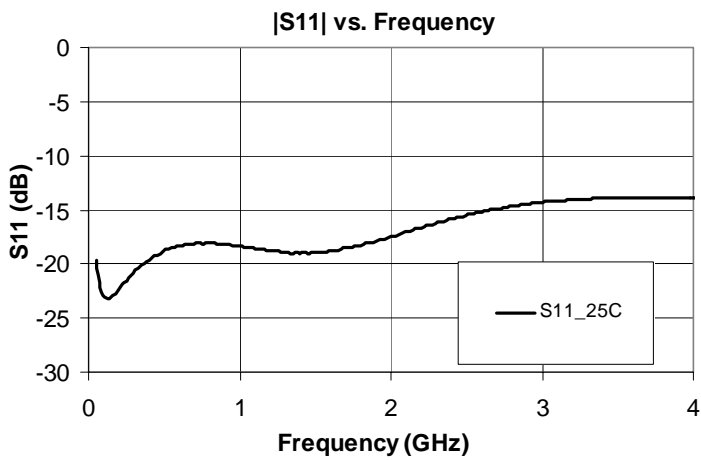
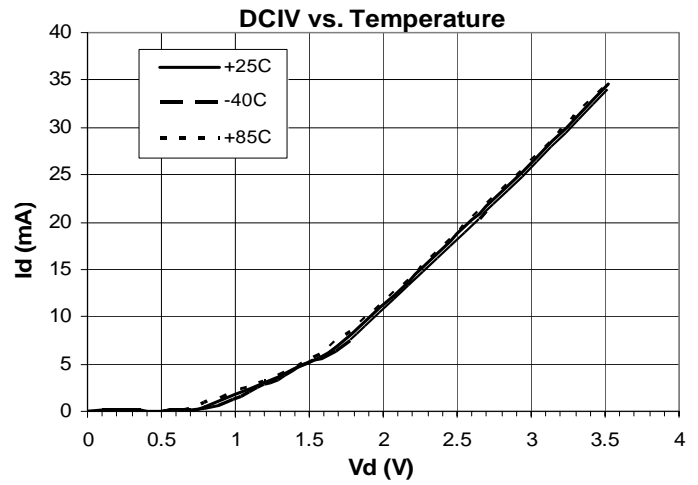
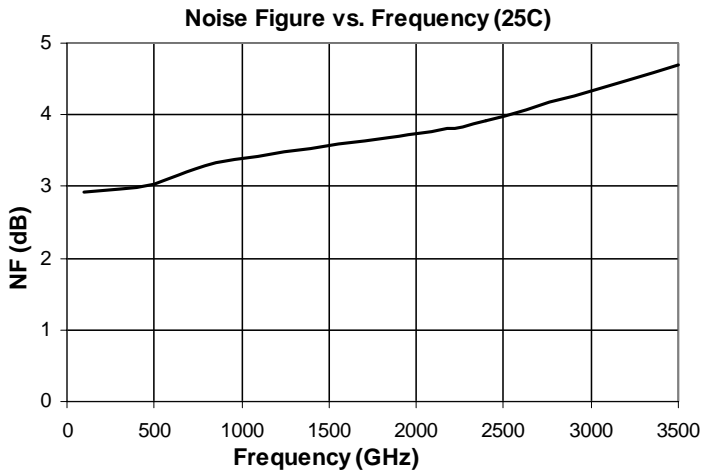

Application Circuit Schematic

Application Circuit Element Values		
Reference Designator	100-2000MHz	2000-4000MHz
C1	1000pF	2.7pF
C2	100pF	6.8pF
C3	100pF	6.8pF
L1	150nH	39nH

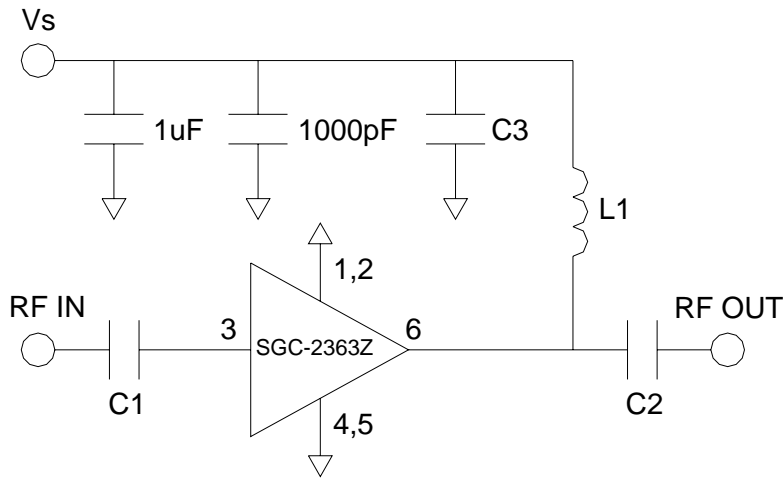

Mounting Instructions

1. Use a large ground pad area under device pins 1, 2, 4 and 5 with many plated through-holes as shown.
2. We recommend 1 or 2 ounce copper. Measurements for this data sheet were made on a 31 mil thick FR-4 board with 1 ounce copper on both sides.

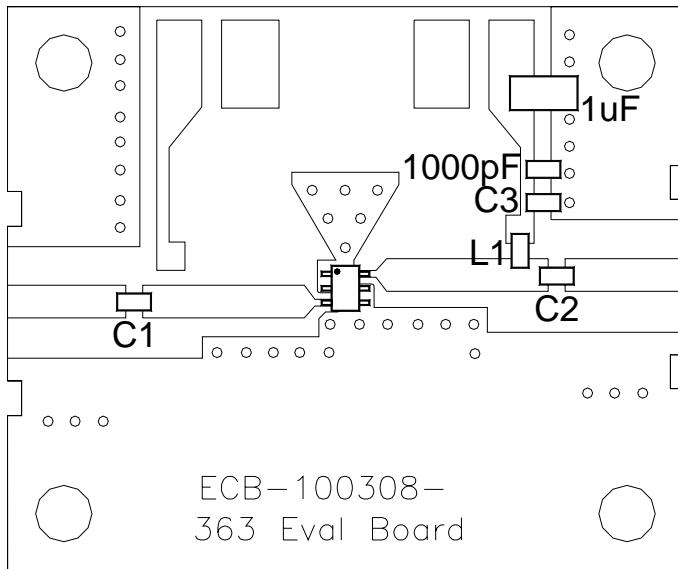

Part Identification Marking & Pinout

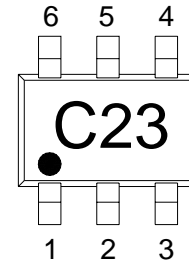

Pin #	Function	Description
3	RF IN	RF input pin. This pin requires the use of an external DC blocking capacitor chosen for the frequency of operation
1,2,4,5	GND	Connection to ground. Use via holes as close to the device ground leads as possible to reduce ground inductance and achieve optimum RF performance
6	RF OUT / DC BIAS	RF output and bias pin. This pin requires the use of an external DC blocking capacitor chosen for the frequency of operation.

Part Number	Package / Lead Composition	Reel Size	Devices / Reel
SGC-2363Z	Lead Free, RoHs Compliant	7"	3000

SOT-363 PCB Pad Layout

Dimensions in inches [millimeters]

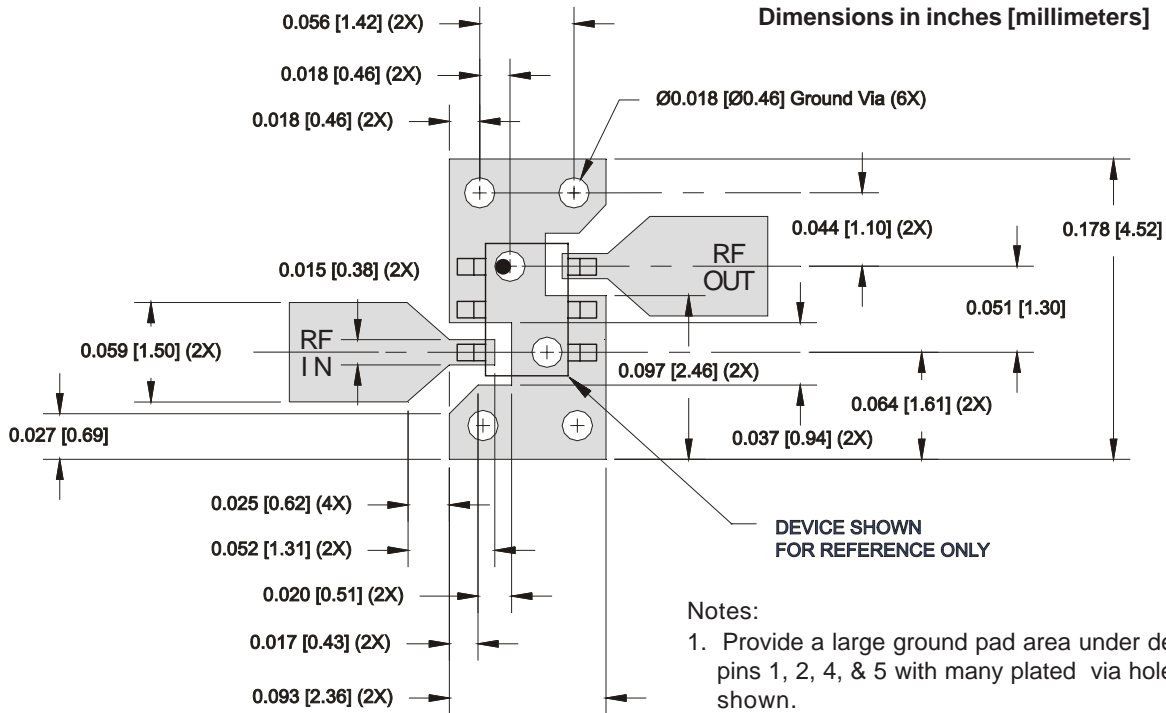

Notes:

1. Provide a large ground pad area under device pins 1, 2, 4, & 5 with many plated via holes as shown.
2. Dimensions given for 50 Ohm RF I/O lines are for 31 mil thick Getek. Scale accordingly for different board thicknesses and dielectric constants.
3. We recommend 1 or 2 ounce copper. Measurements for this data sheet were made on a 31 mil thick Getek with 1 ounce copper on both sides.

SOT-363 Nominal Package Dimensions

Dimensions in inches [millimeters]

A link to the SOT-363 package outline drawing with full dimensions and tolerances may be found on the product web page at www.sirenza.com.

