

SG - 267

The SG – 267 photointerrupter high – performance standard type,combines high – output GaAs IRED with high sensitive phototransistor.

FEATURES

- PWB direct mount type
- GAP : 4.2mm
- Snap–in mount
- With the installation positioning boss

APPLICATIONS

- Cassette mecha
- Facsimiles
- CD changers
- VTR

DIMENSIONS

(Unit : mm)

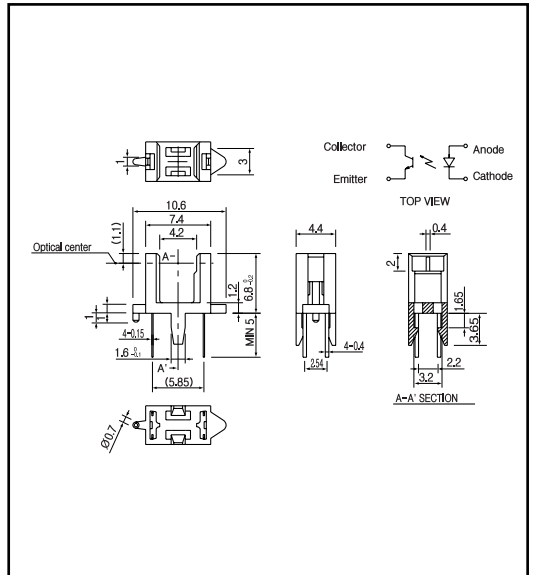

MAXIMUM RATINGS

(Ta=25)

Item	Symbol	Rating	Unit
Input	Power dissipation	P _d	75 mW
	Forward current	I _F	50 mA
	Reverse voltage	V _R	5 V
	Pulse forward current ^{*1}	I _{FP}	0.5 A
Output	Collector power dissipation	P _c	75 mW
	Collector current	I _c	20 mA
	C - E voltage	V _{CEO}	30 V
	E - C voltage	V _{ECD}	5 V
Operating temp. ^{*2}	T _{opr.}	- 20 ~ + 85	
Storage temp. ^{*2}	T _{stg.}	- 30 ~ + 100	
Soldering temp. ^{*3}	T _{sol.}	260	

*1. pulse width : t w 100 ꝑec.period : T=10msec.

*2. No icebound or dew

*3. For MAX.5 seconds at the position of 1mm from the package

ELECTRO-OPTICAL CHARACTERISTICS

(Ta=25)

Item	Symbol	Conditions	Min.	Typ.	Max.	Unit.
Input	Forward voltage	I _F =20mA		1.2	1.4	V
	Reverse current	V _R =5V			10	ꝑA
	Peak wavelength	I _F =20mA		940		nm
Output	Collector dark current	V _{CE} =10V		1	100	nA
	Light current	I _F =20mA, V _E =5V, Non – shading	0.2		5	ꝑA
Transmissi	leakage current	I _{CEOD}		0.5	5	ꝑA
	C - E saturation voltage	I _F =20mA, I _c =0.05mA		0.15	0.4	V
	Rise time	V _{CC} =5V, I _F =0.1mA, R=1K		50		ꝑsec.
	Fall time			50		ꝑsec.

Photointerrupters(Transmissive)

SG - 267

Collector power dissipation Vs. Ambient temperature

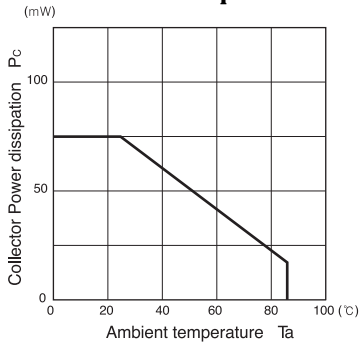

Forward current Vs. Forward voltage

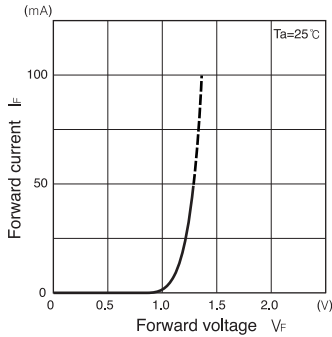

Light current Vs. Forward current

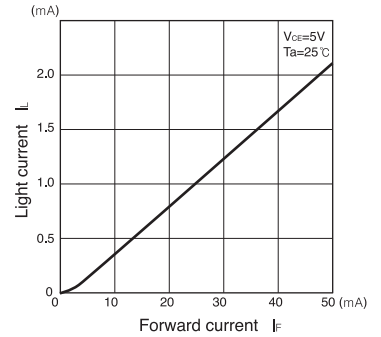

Light current Vs. Collector-Emitter voltage

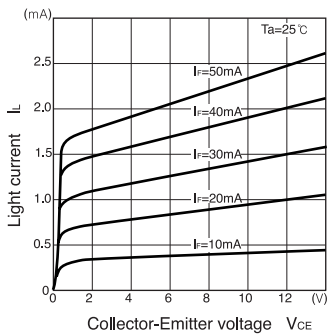

Relative light current Vs. Ambient temperature

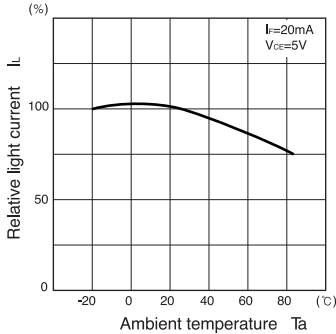

Dark current Vs. Ambient temperature

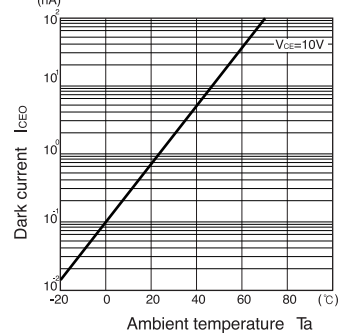

Switching time Vs. Load resistance

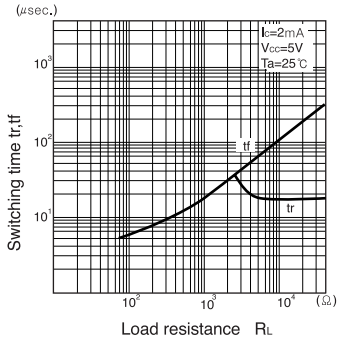

Relative light current Vs. Moving distance

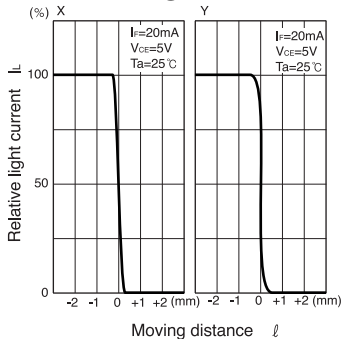

Switching time measurement circuit

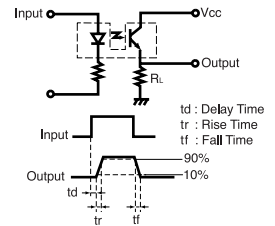

Method of measuring position detection characteristic

