

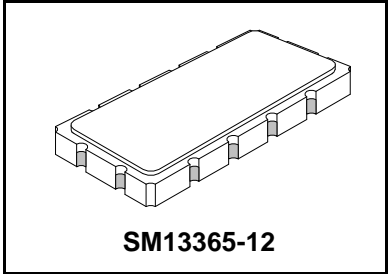

SF1087A

**208 MHz
SAW Filter**



- **Designed for GSM BTS Transmitter IF Applications**
- **Low Insertion Loss**
- **Excellent Size-to-Performance Ratio**
- **Hermetic 13.3 x 6.5 mm Surface-Mount Case**
- **Unbalanced Input and Output**
- **Complies with Directive 2002/95/EC (RoHS)**

Absolute Maximum Ratings

Rating	Value	Units
Maximum Incident Power in Passband	+10	dBm
Max. DC voltage between any 2 terminals	30	VDC
Storage Temperature Range	-40 to +85	°C
Suitable for lead-free soldering - Max. Soldering Profile	260°C for 30 s	

Electrical Characteristics

Characteristic	Sym	Notes	Min	Typ	Max	Units
Nominal Center Frequency	f_C	1	208.000			MHz
Passband	Insertion Loss at f_C	IL		5	7.0	dB
	1 dB Passband	BW_1	1, 2	± 150	± 260	kHz
	Amplitude Ripple over $f_C \pm 150$ kHz				1.25	dB _{p-p}
	Group Delay Variation over $f_C \pm 150$ kHz	GDV			<100	ns _{p-p}
Rejection	Absolute Group Delay	GD	0.7	1.0	1.7	μ s
	$f_C - 0.6$ to $f_C - 0.4$ and $f_C + 0.4$ to $f_C + 0.6$ MHz		2			dB
	$f_C - 1.2$ to $f_C - 0.6$ and $f_C + 0.6$ to $f_C + 1.2$ MHz		8			
	$f_C - 1.8$ to $f_C - 1.2$ and $f_C + 1.2$ to $f_C + 1.8$ MHz		20	22		
	$f_C - 3.4$ to $f_C - 1.8$ and $f_C + 1.8$ to $f_C + 3.4$ MHz		25	36		
	$f_C - 9.5$ to $f_C - 3.4$ and $f_C + 3.4$ to $f_C + 9.5$ MHz		30	47		
	$f_C - 13$ to $f_C - 9.5$ and $f_C + 9.5$ to $f_C + 13$ MHz		43	64		
DC to $f_C - 13$ and $f_C + 13$ to 450 MHz Except Spurious Rejection near 1.6, 1.8, and 2.0 x f_C		55	65			
Operating Temperature Range	T_A	1	-10		+85	°C

Impedance Matching to 50 Ω unbalanced	External L-C
Case Style	SM13365-12 13.3 x 6.5 mm Nominal Footprint
Lid Symbolization (YY = year, WW = week)	RFM SF1087A YYWW

Notes:

1. Unless noted otherwise, all specifications apply over the operating temperature range with filter soldered to the specified demonstration board with impedance matching to 50 Ω and measured with 50 Ω network analyzer.
2. Unless noted otherwise, all frequency specifications are referenced to the nominal center frequency, f_C .
3. Rejection is measured as attenuation below the minimum IL point in the passband. Rejection in final user application is dependent on PCB layout and external impedance matching design. See Application Note No. 42 for details.
4. "LRIP" or "L" after the part number indicates "low rate initial production" and "ENG" or "E" indicates "engineering prototypes."
5. The design, manufacturing process, and specifications of this filter are subject to change.
6. Either Port 1 or Port 2 may be used for either input or output in the design. However, impedances and impedance matching may vary between Port 1 and Port 2, so that the filter must always be installed in one direction per the circuit design.
7. US and international patents may apply.
8. Electrostatic Sensitive Device. Observe precautions for handling.

Electrical Connections

Connection	Terminals
Port 1 Hot	2
Port 1 Gnd Return	3
Port 2 Hot	8
Port 2 Gnd Return	9
Case Ground	All others

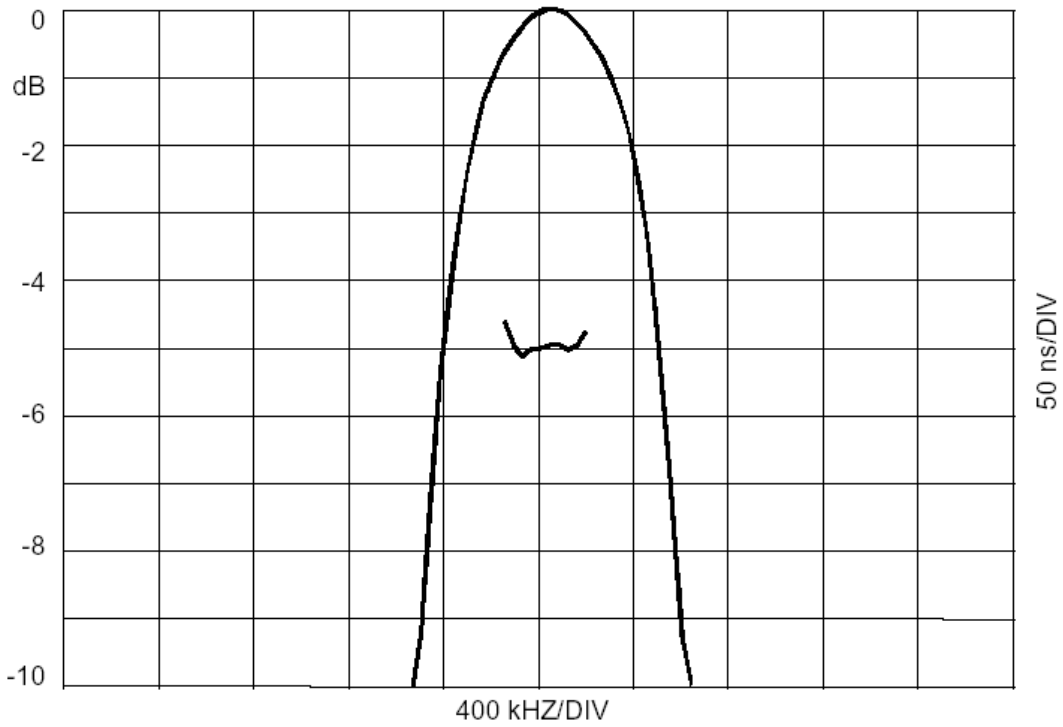
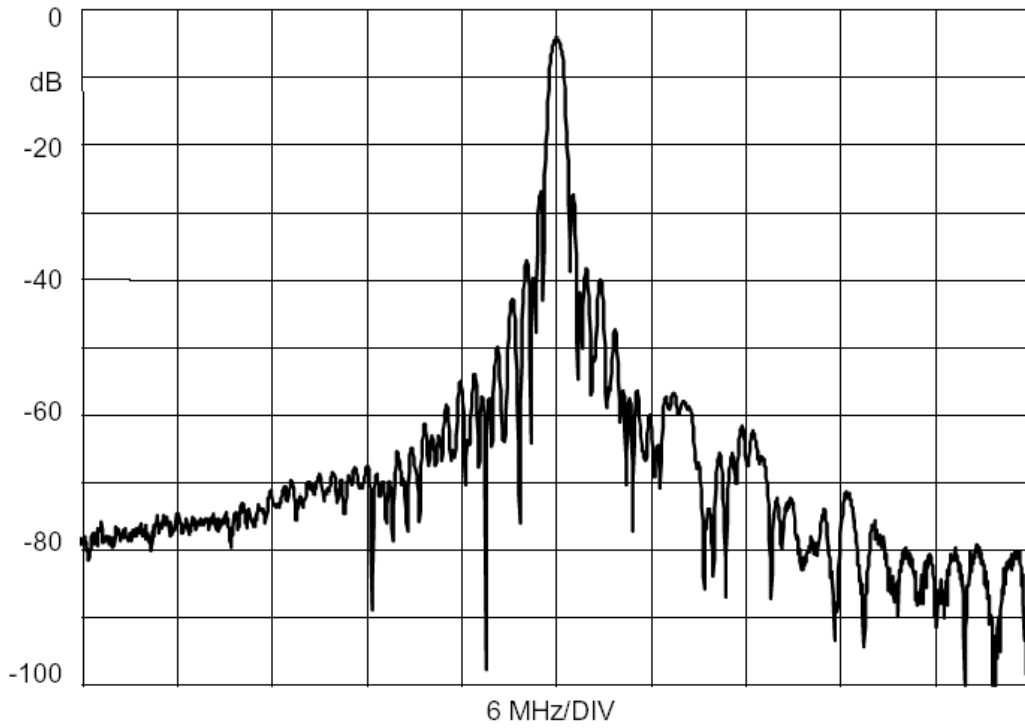

SM13365-12 Case

12-Terminal Ceramic Surface-Mount Case
13.3 x 6.5 mm Nominal Footprint

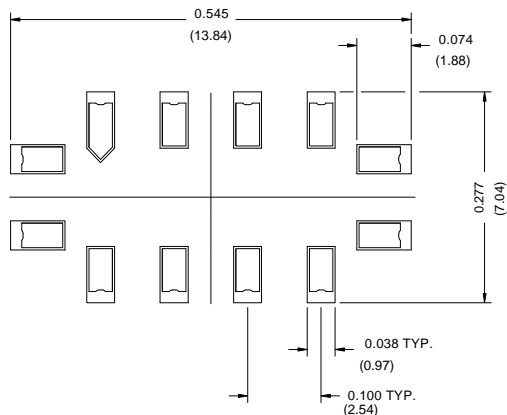
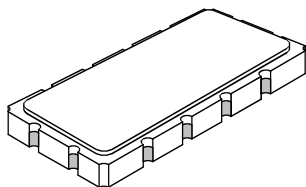

Case Dimensions						
Dimension	mm			Inches		
	Min	Nom	Max	Min	Nom	Max
A	13.08	13.31	13.60	0.515	0.524	0.535
B	6.27	6.50	6.80	0.247	0.256	0.268
C		1.91	2.00		0.075	0.079
D		1.50			0.059	
E		0.79			0.031	
H		1.0			0.039	
P		2.54			0.100	

Electrical Connections		
Connection		Terminals
Port 1	Input or Return	2
	Return or Input	3
Port 2	Output or Return	8
	Return or Output	9
Ground		All others
Single Ended Operation		Return is ground
Differential Operation		Return is hot

Materials	
Solder Pad Termination	Au plating 30 - 60 pinches (76.2-152 μm) over 80-200 pinches (203-508 μm) Ni.
Lid	Fe-Ni-Co Alloy Electroless Nickel Plate (8-11% Phosphorus) 100-200 pinches Thick
Body	Al ₂ O ₃ Ceramic
Pb Free	

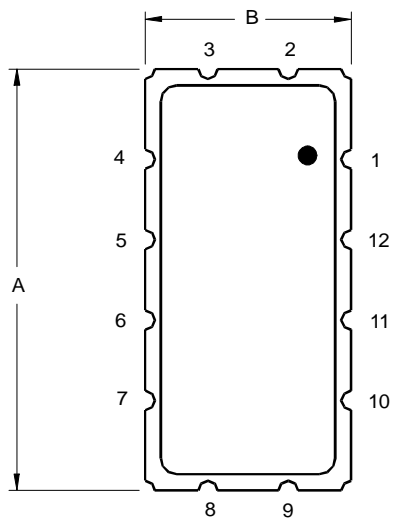

TOP VIEW

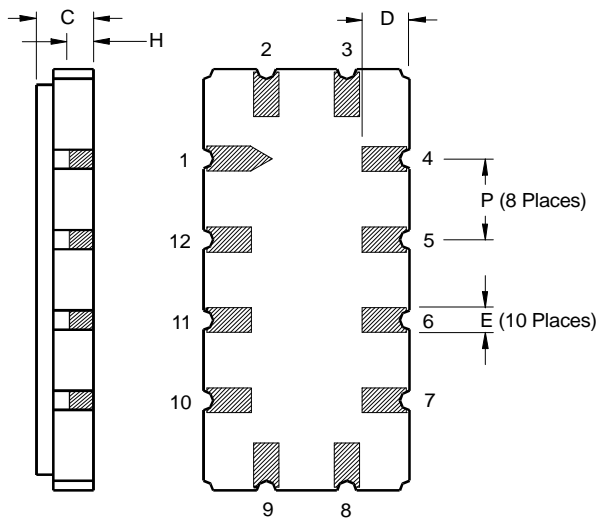

BOTTOM VIEW