

# DATA SHEET

118 AHT

**Aluminum electrolytic capacitors**  
**Axial High Temperature**

Product specification  
Supersedes data of 11th December 2001  
File under BCcomponents, BC01

2002 Jun 07

# Aluminum electrolytic capacitors

## Axial High Temperature

118 AHT

**FEATURES**

- Polarized aluminum electrolytic capacitors, non-solid electrolyte
- Axial leads, cylindrical aluminium case, insulated with a blue sleeve
- Mounting ring version not insulated
- Taped versions up to case  $\varnothing 15 \times 30$  mm available for automatic insertion
- Charge and discharge proof
- Extra long useful life: up to 8000 hours at 125 °C, high reliability
- Extended temperature range: 125 °C (usable up to 150 °C)
- Miniaturized, high CV-product per unit volume.

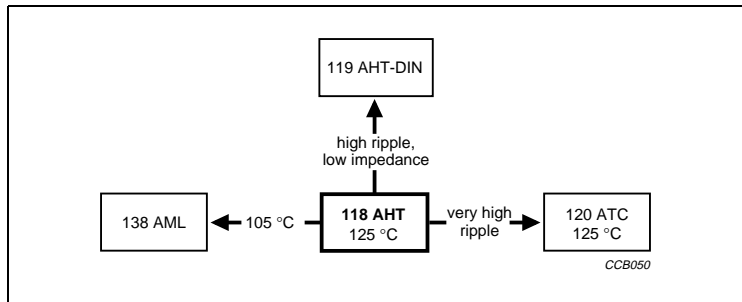
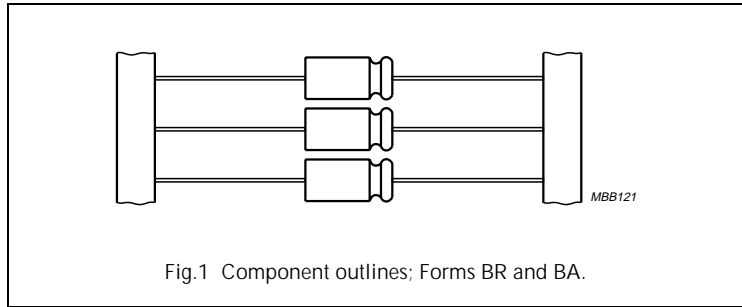

**APPLICATIONS**

- Automotive, industrial and telecommunication
- Smoothing, filtering, coupling, decoupling, timing
- For use after very long storage (10 years) without voltage applied
- Portable and mobile equipment (small size, low mass)
- Low mounting height boards, vibration and shock resistant
- Outdoor applications, e.g. aerial amplifiers.

**QUICK REFERENCE DATA**

DESCRIPTION	VALUE	
Case sizes ( $\varnothing D_{nom} \times L_{nom}$ in mm)	6.5 × 18 to 10 × 25	10 × 30 to 21 × 38
Rated capacitance range, $C_R$	1 to 10000 $\mu F$	
Tolerance on $C_R$	±20%	
Rated voltage range, $U_R$	6.3 to 200 V	
Category temperature range	-40 to +125 °C	-55 to +125 °C
Endurance test at 150 °C (6.3 to 100 V)	500 hours	500 hours
Endurance test at 125 °C	2000 hours	3000 hours
Useful life at 125 °C	4000 hours	8000 hours
Useful life at 40 °C, $1.8 \times I_R$ applied	500000 hours	1000000 hours
Shelf life at 0 V, 125 °C: $U_R = 6.3$ to 63 V $U_R = 100$ and 200 V	500 hours 100 hours	
Based on sectional specification	IEC 60384-4/EN130300	
Climatic category IEC 60068	40/125/56	55/125/56

# Aluminum electrolytic capacitors

## Axial High Temperature

118 AHT

Selection chart for  $C_R$ ,  $U_R$  and relevant nominal case sizes ( $\varnothing D \times L$  in mm)

Preferred types in **bold**.

$C_R$ ( $\mu\text{F}$ )	$U_R$ (V)							
	6.3	10	16	25	40	63	100	200
1.0	–	–	–	–	–	6.5 × 18	–	–
2.2	–	–	–	–	–	6.5 × 18	–	–
4.7	–	–	–	–	–	6.5 × 18	6.5 × 18	8 × 18
<b>10</b>	–	–	–	–	–	<b>6.5 × 18</b>	6.5 × 18	10 × 25
15	–	–	–	–	–	–	–	10 × 30
<b>22</b>	–	–	–	–	–	<b>6.5 × 18</b>	8 × 18	<b>12.5 × 30</b>
33	–	–	–	–	–	–	10 × 25	15 × 30
<b>47</b>	–	–	–	–	<b>6.5 × 18</b>	8 × 18	10 × 25	<b>18 × 30</b>
	–	–	–	–	–	–	<b>10 × 30</b>	–
68	–	–	–	–	–	–	12.5 × 30	–
<b>100</b>	–	–	–	<b>6.5 × 18</b>	<b>8 × 18</b>	<b>10 × 25</b>	<b>12.5 × 30</b>	<b>21 × 38</b>
	–	–	–	–	–	<b>10 × 30</b>	–	–
150	–	–	–	–	10 × 18	12.5 × 30	–	–
<b>220</b>	–	6.5 × 18	8 × 18	<b>10 × 18</b>	10 × 25	<b>12.5 × 30</b>	<b>18 × 30</b>	–
	–	–	–	–	<b>10 × 30</b>	–	–	–
330	–	8 × 18	–	–	12.5 × 30	–	–	–
<b>470</b>	–	<b>8 × 18</b>	<b>10 × 18</b>	<b>10 × 25</b>	<b>12.5 × 30</b>	<b>18 × 30</b>	<b>21 × 38</b>	–
	–	–	–	<b>10 × 30</b>	–	–	–	–
680	–	–	–	12.5 × 30	–	–	–	–
<b>1000</b>	10 × 18	10 × 25	<b>12.5 × 30</b>	<b>12.5 × 30</b>	<b>18 × 30</b>	<b>21 × 38</b>	–	–
	–	<b>10 × 30</b>	–	–	–	–	–	–
1500	10 × 25	12.5 × 30	12.5 × 30	15 × 30	18 × 38	–	–	–
<b>2200</b>	–	<b>12.5 × 30</b>	<b>15 × 30</b>	<b>18 × 30</b>	<b>21 × 38</b>	–	–	–
3300	–	15 × 30	18 × 30	18 × 38	–	–	–	–
<b>4700</b>	–	<b>18 × 30</b>	<b>18 × 38</b>	<b>21 × 38</b>	–	–	–	–
6800	–	18 × 38	21 × 38	–	–	–	–	–
<b>10000</b>	–	<b>21 × 38</b>	–	–	–	–	–	–

# Aluminum electrolytic capacitors

## Axial High Temperature

118 AHT

### MECHANICAL DATA, AVAILABLE FORMS AND PACKAGING QUANTITIES

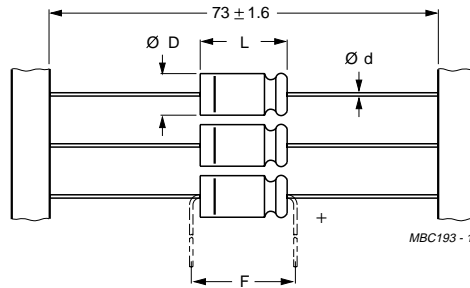

Dimensions in mm.

**Form BR:** Taped on reel,  
case  $\varnothing D \times L = 6.5 \times 18$  to  $15 \times 30$  mm.

**Form BA:** Taped in box (ammopack),  
case  $\varnothing D \times L = 6.5 \times 18$  to  $10 \times 25$  mm.

For dimensions see Table 1.

Tape dimensions are specified in data handbook BC01, section "Packaging".

Fig.2 Dimensional outline; Forms BA and BR.

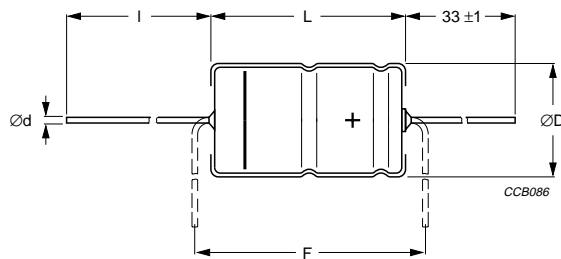

Dimensions in mm.

**Form AA:** Axial in box,  
case  $\varnothing D \times L = 10 \times 30$  to  $21 \times 38$  mm.

For dimensions see Table 1.

Fig.3 Dimensional outline; Form AA.

# Aluminum electrolytic capacitors

## Axial High Temperature

118 AHT

**Table 1 Axial:** physical dimensions, mass and packaging quantities; see Figs 2 and 3

NOMINAL CASE SIZE ∅D × L (mm)	CASE CODE	AXIAL: FORM AA, BA and BR					MASS (g)	PACKAGING QUANTITIES		
		∅d (mm)	l (mm)	∅D <sub>max</sub> (mm)	L <sub>max</sub> (mm)	F <sub>min</sub> (mm)		FORM AA	FORM BA	FORM BR
6.5 × 18	4	0.8	–	6.9	18.5	25	≈1.3	–	1000	1000
8 × 18	5	0.8	–	8.5	18.5	25	≈1.7	–	500	500
10 × 18	6	0.8	–	10.5	18.5	25	≈2.5	–	500	500
10 × 25	7	0.8	–	10.5	25.0	30	≈3.3	–	500	500
10 × 30	00	0.8	55 ±1	10.5	30.5	35	≈4.8	200	–	500
12.5 × 30	01	0.8	55 ±1	13.0	30.5	35	≈7.4	200	–	400
15 × 30	02	0.8	55 ±1	15.5	30.5	35	≈11.7	200	–	250
18 × 30	03	0.8	55 ±1	18.5	30.5	35	≈12.9	200	–	–
18 × 38	04	0.8	34 ±1	18.5	39.0	44	≈19.0	100	–	–
21 × 38	05	0.8	34 ±1	21.5	39.0	44	≈24.0	100	–	–

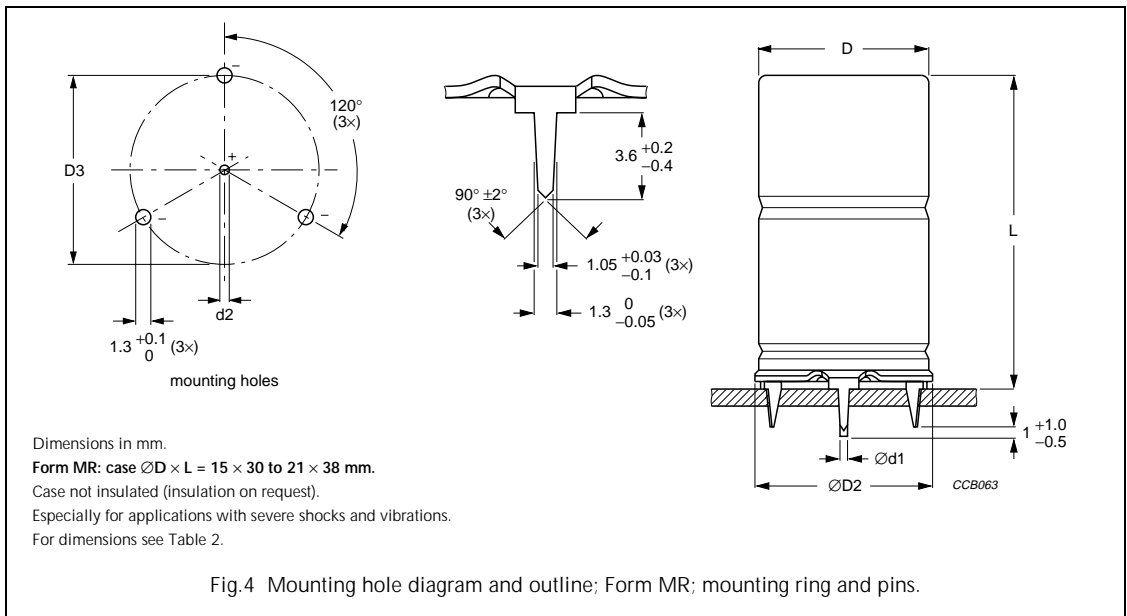

**Table 2 Mounting ring;** physical dimensions, mass and packaging quantities; see Fig. 4

NOMINAL CASE SIZE ∅D × L (mm)	CASE CODE	MOUNTING RING: FORM MR						MASS (g)	PACKAGING QUANTITIES
		∅d1 (mm)	∅d2 (mm)	∅D <sub>max</sub> (mm)	∅D2 <sub>max</sub> (mm)	D3 (mm)	L <sub>max</sub> (mm)		
15 × 30	02	0.8	1.0 +0.4	15.5	17.5	16.5 ±0.2	33	≈8.6	200
18 × 30	03	0.8	1.0 +0.4	18.5	19.5	18.5 ±0.2	33	≈11.5	200
18 × 38	04	0.8	1.0 +0.4	18.5	19.5	18.5 ±0.2	42	≈14.0	100
21 × 38	05	0.8	1.0 +0.4	21.5	22.5	21.5 ±0.2	42	≈19.0	100

# Aluminum electrolytic capacitors

## Axial High Temperature

### 118 AHT

### Ordering example

Electrolytic capacitor 118 series

1000  $\mu$ F/10 V;  $\pm$ 20%

Nominal case size:  $\varnothing$ 10  $\times$  30 mm; Form BR

Catalogue number: 2222 118 24102.

### ELECTRICAL DATA AND ORDERING INFORMATION

Unless otherwise specified, all electrical values in Table 3 apply at  $T_{amb} = 20\text{ }^{\circ}\text{C}$ ,  
 $P = 86$  to  $106$  kPa,  $RH = 45$  to  $75\%$ .

$C_R$	rated capacitance at 100 Hz, tolerance $\pm$ 20%
$I_R$	rated RMS ripple current at 100 Hz, 125 $^{\circ}\text{C}$
$I_{L1}$	max. leakage current after 1 minute at $U_R$
$I_{L5}$	max. leakage current after 5 minutes at $U_R$
Tan $\delta$	max. dissipation factor at 100 Hz
ESR	equivalent series resistance at 100 Hz (calculated from tan $\delta_{max}$ and $C_R$ )
Z	max. impedance at 10 kHz

**Table 3** Electrical data and ordering information; preferred types in **bold**

$U_R$ (V)	$C_R$ 100 Hz ( $\mu$ F)	NOMINAL CASE SIZE $\varnothing D \times L$ (mm)	CASE CODE	$I_R$ 100 Hz 125 $^{\circ}\text{C}$ (mA)	$I_{L1}$ 1 min ( $\mu$ A)	$I_{L5}$ 5 min ( $\mu$ A)	Tan $\delta$ 100 Hz	ESR 100 Hz ( $\Omega$ )	Z 10 kHz ( $\Omega$ )	CATALOGUE NUMBER 2222 ... ..			
										IN BOX FORM AA	TAPED ON REEL FORM BR	TAPED IN BOX FORM BA	MOUNTING RING FORM MR
6.3	1000	10 $\times$ 18	6	251	42	17	0.50	0.79	0.8	–	118 23102	118 33102	–
	1500	10 $\times$ 25	7	352	61	23	0.50	0.53	0.53	–	118 90502	118 90503	–
10	220	6.5 $\times$ 18	4	109	20	8.4	0.35	2.53	2.1	–	118 24221	118 34221	–
	330	8 $\times$ 18	5	150	24	11	0.35	1.69	1.4	–	118 24331	118 34331	–
	<b>470</b>	<b>8 <math>\times</math> 18</b>	<b>5</b>	179	32	13	0.35	1.19	1.0	–	118 24471	<b>118 34471</b>	–
	1000	10 $\times$ 25	7	343	64	24	0.35	0.56	0.55	–	118 90504	118 90505	–
	<b>1000</b>	<b>10 <math>\times</math> 30</b>	<b>00</b>	550	64	24	0.32	0.505	0.45	<b>118 14102</b>	<b>118 24102</b>	–	–
	1500	12.5 $\times$ 30	01	740	94	34	0.32	0.340	0.28	118 14152	118 24152	–	–
	<b>2200</b>	<b>12.5 <math>\times</math> 30</b>	<b>01</b>	830	136	48	0.40	0.290	0.27	<b>118 14222</b>	<b>118 24222</b>	–	–
	3300	15 $\times$ 30	02	1070	202	70	0.40	0.190	0.18	118 14332	118 24332	–	118 44332
	<b>4700</b>	<b>18 <math>\times</math> 30</b>	<b>03</b>	1350	286	98	0.46	0.155	0.15	<b>118 14472</b>	–	–	<b>118 44472</b>
	6800	18 $\times$ 38	04	1730	412	140	0.53	0.100	0.10	118 14682	–	–	118 44682
<b>10000</b>	<b>21 <math>\times</math> 38</b>	<b>05</b>	1860	604	200	0.53	0.084	0.10	<b>118 14103</b>	–	–	<b>118 44103</b>	
16	220	8 $\times$ 18	5	145	25	11	0.25	1.81	1.5	–	118 25221	118 35221	–
	330	10 $\times$ 18	6	204	36	15	0.25	1.21	1.2	–	118 25331	118 35331	–
	<b>470</b>	<b>10 <math>\times</math> 18</b>	<b>6</b>	243	49	19	0.25	0.85	0.83	–	118 25471	<b>118 35471</b>	–
	680	10 $\times$ 30	00	510	69	30	0.22	0.525	0.45	118 15681	118 25681	–	–

# Aluminum electrolytic capacitors

## Axial High Temperature

### 118 AHT

U <sub>R</sub> (V)	C <sub>R</sub> 100 Hz (μF)	NOMINAL CASE SIZE ∅D × L (mm)	CASE CODE	I <sub>R</sub> 100 Hz 125 °C (mA)	I <sub>L1</sub> 1 min (μA)	I <sub>L5</sub> 5 min (μA)	Tan δ 100 Hz	ESR 100 Hz (Ω)	Z 10 kHz (Ω)	CATALOGUE NUMBER 2222 ... ..			
										IN BOX FORM AA	TAPED ON REEL FORM BR	TAPED IN BOX FORM BA	MOUNTING RING FORM MR
16	<b>1000</b>	<b>12.5 × 30</b>	<b>01</b>	720	100	36	0.22	0.345	0.28	<b>118 15102</b>	<b>118 25102</b>	–	–
	1500	12.5 × 30	01	790	148	52	0.29	0.305	0.27	118 15152	118 25152	–	–
	<b>2200</b>	<b>15 × 30</b>	<b>02</b>	1010	215	74	0.29	0.205	0.18	<b>118 15222</b>	<b>118 25222</b>	–	<b>118 45222</b>
	3300	18 × 30	03	1300	321	110	0.34	0.165	0.15	118 15332	–	–	118 45332
	<b>4700</b>	<b>18 × 38</b>	<b>04</b>	1670	455	150	0.34	0.105	0.10	<b>118 15472</b>	–	–	<b>118 45472</b>
	6800	21 × 38	05	1790	657	220	0.38	0.088	0.10	118 15682	–	–	118 45682
25	<b>100</b>	<b>6.5 × 18</b>	<b>4</b>	102	20	9	0.18	2.86	2.3	–	118 26101	<b>118 36101</b>	–
	<b>220</b>	<b>10 × 18</b>	<b>6</b>	196	37	15	0.18	1.30	1.25	–	118 26221	<b>118 36221</b>	–
	330	10 × 25	7	274	54	21	0.18	0.87	0.82	–	118 26331	118 36331	–
	<b>470</b>	<b>10 × 25</b>	<b>7</b>	327	75	28	0.18	0.61	0.57	–	118 90508	<b>118 90509</b>	–
	<b>470</b>	<b>10 × 30</b>	<b>00</b>	490	75	28	0.18	0.61	0.50	<b>118 16471</b>	<b>118 26471</b>	–	–
	680	12.5 × 30	01	680	106	38	0.18	0.42	0.30	118 16681	118 26681	–	–
	<b>1000</b>	<b>12.5 × 30</b>	<b>01</b>	760	154	54	0.24	0.375	0.28	<b>118 16102</b>	<b>118 26102</b>	–	–
	1500	15 × 30	02	980	229	79	0.25	0.263	0.22	118 16152	118 26152	–	118 46152
	<b>2200</b>	<b>18 × 30</b>	<b>03</b>	1240	334	110	0.26	0.185	0.17	<b>118 16222</b>	–	–	<b>118 46222</b>
	3300	18 × 38	04	1610	499	170	0.26	0.12	0.11	118 16332	–	–	118 46332
<b>4700</b>	<b>21 × 38</b>	<b>05</b>	1710	709	240	0.28	0.095	0.10	<b>118 16472</b>	–	–	<b>118 46472</b>	
40	<b>47</b>	<b>6.5 × 18</b>	<b>4</b>	89.8	20	7.8	0.11	3.72	2.8	–	118 27479	<b>118 37479</b>	–
	<b>100</b>	<b>8 × 18</b>	<b>5</b>	147	28	12	0.11	1.75	1.3	–	118 27101	<b>118 37101</b>	–
	150	10 × 18	6	207	40	16	0.11	1.17	1.0	–	118 27151	118 37151	–
	220	10 × 25	7	287	57	22	0.11	0.80	0.68	–	118 90511	118 90512	–
	<b>220</b>	<b>10 × 30</b>	<b>00</b>	390	57	22	0.10	0.70	0.55	<b>118 17221</b>	<b>118 27221</b>	–	–
	330	12.5 × 30	01	570	83	30	0.10	0.43	0.33	118 17331	118 27331	–	–
	<b>470</b>	<b>12.5 × 30</b>	<b>01</b>	620	117	42	0.11	0.38	0.30	<b>118 17471</b>	<b>118 27471</b>	–	–
	680	15 × 30	02	810	167	58	0.11	0.255	0.23	118 17681	118 27681	–	118 47681
	<b>1000</b>	<b>18 × 30</b>	<b>03</b>	1070	244	84	0.13	0.205	0.18	<b>118 17102</b>	–	–	<b>118 47102</b>
	1500	18 × 38	04	1390	364	120	0.13	0.13	0.11	118 17152	–	–	118 47152
<b>2200</b>	<b>21 × 38</b>	<b>05</b>	1540	532	180	0.15	0.105	0.10	<b>118 17222</b>	–	–	<b>118 47222</b>	

# Aluminum electrolytic capacitors

## Axial High Temperature

### 118 AHT

U <sub>R</sub> (V)	C <sub>R</sub> 100 Hz (μF)	NOMINAL CASE SIZE ∅D × L (mm)	CASE CODE	I <sub>R</sub> 100 Hz 125 °C (mA)	I <sub>L1</sub> 1 min (μA)	I <sub>L5</sub> 5 min (μA)	Tan δ 100 Hz	ESR 100 Hz (Ω)	Z 10 kHz (Ω)	CATALOGUE NUMBER 2222 ... ..			
										IN BOX FORM AA	TAPED ON REEL FORM BR	TAPED IN BOX FORM BA	MOUNTING RING FORM MR
63	1.0	6.5 × 18	4	16.4	20	4.1	0.07	110	22	–	118 28108	118 38108	–
	2.2	6.5 × 18	4	24.3	20	4.3	0.07	51	15	–	118 28228	118 38228	–
	4.7	6.5 × 18	4	35.6	20	4.6	0.07	24	8.9	–	118 28478	118 38478	–
	<b>10</b>	<b>6.5 × 18</b>	<b>4</b>	51.9	20	5.3	0.07	11	5.6	–	118 28109	<b>118 38109</b>	–
	<b>22</b>	<b>6.5 × 18</b>	<b>4</b>	77.0	20	6.8	0.07	5.1	3.2	–	118 28229	<b>118 38229</b>	–
	<b>47</b>	<b>8 × 18</b>	<b>5</b>	126	22	9.9	0.07	2.4	1.5	–	118 28479	<b>118 38479</b>	–
	100	10 × 25	7	243	42	17	0.07	1.1	0.7	–	118 90513	118 90514	–
	<b>100</b>	<b>10 × 30</b>	<b>00</b>	340	42	17	0.07	1.91	1.62	<b>118 18101</b>	<b>118 28101</b>	–	–
	150	12.5 × 30	01	490	61	23	0.07	1.00	0.79	118 18151	118 28151	–	–
	<b>220</b>	<b>12.5 × 30</b>	<b>01</b>	550	87	32	0.08	0.94	0.82	<b>118 18221</b>	<b>118 28221</b>	–	–
	330	15 × 30	02	730	129	46	0.09	0.63	0.56	118 18331	118 28331	–	118 48331
	<b>470</b>	<b>18 × 30</b>	<b>03</b>	970	182	63	0.09	0.44	0.39	<b>118 18471</b>	–	–	<b>118 48471</b>
	680	18 × 38	04	1230	261	90	0.09	0.30	0.26	118 18681	–	–	118 48681
<b>1000</b>	<b>21 × 38</b>	<b>05</b>	1400	383	130	0.10	0.16	0.20	<b>118 18102</b>	–	–	<b>118 48102</b>	
100	4.7	6.5 × 18	4	36	20	4.9	0.07	24	19	–	118 29478	118 39478	–
	10	6.5 × 18	4	52	20	6.0	0.07	11	9.0	–	118 29109	118 39109	–
	22	8 × 18	5	91	20	8.4	0.07	5.1	4.0	–	118 29229	118 39229	–
	33	10 × 25	7	140	24	11	0.07	3.4	2.7	–	118 29339	118 39339	–
	47	10 × 25	7	170	33	13	0.07	2.6	2.0	–	118 90535	118 90536	–
	<b>47</b>	<b>10 × 30</b>	<b>00</b>	240	33	13	0.08	2.6	2.0	<b>118 19479</b>	<b>118 29479</b>	–	–
	68	12.5 × 30	01	320	45	18	0.08	1.8	1.2	118 19689	118 29689	–	–
	<b>100</b>	<b>12.5 × 30</b>	<b>01</b>	380	64	24	0.09	1.4	1.15	<b>118 19101</b>	<b>118 29101</b>	–	–
	150	15 × 30	02	500	94	34	0.10	0.94	0.78	118 19151	118 29151	–	118 49151
	<b>220</b>	<b>18 × 30</b>	<b>03</b>	690	136	48	0.10	0.66	0.55	<b>118 19221</b>	–	–	<b>118 49221</b>
	330	18 × 38	04	890	202	70	0.10	0.45	0.37	118 19331	–	–	118 49331
	<b>470</b>	<b>21 × 38</b>	<b>05</b>	1050	286	98	0.10	0.33	0.28	<b>118 19471</b>	–	–	<b>118 49471</b>



# Aluminum electrolytic capacitors

## Axial High Temperature

118 AHT

U <sub>R</sub> (V)	C <sub>R</sub> 100 Hz (μF)	NOMINAL CASE SIZE ∅D × L (mm)	CASE CODE	I <sub>R</sub> 100 Hz 125 °C (mA)	I <sub>L1</sub> 1 min (μA)	I <sub>L5</sub> 5 min (μA)	Tan δ 100 Hz	ESR 100 Hz (Ω)	Z 10 kHz (Ω)	CATALOGUE NUMBER 2222 ... ..			
										IN BOX FORM AA	TAPED ON REEL FORM BR	TAPED IN BOX FORM BA	MOUNTING RING FORM MR
200	2.2	6.5 × 18	4	27	20	4.9	0.06	44	23	–	118 90537	118 90538	–
	4.7	8 × 18	5	46	20	5.9	0.06	21	11	–	118 90539	118 90541	–
	10	10 × 25	7	85	20	8.0	0.06	9.4	5.0	–	118 90542	118 90543	–
	15	10 × 30	00	150	22	10	0.046	4.76	3.75	118 92159	118 90012	–	–
	<b>22</b>	<b>12.5 × 30</b>	<b>01</b>	210	31	13	0.046	3.17	2.22	<b>118 92229</b>	<b>118 90013</b>	–	–
	33	15 × 30	02	290	44	17	0.046	2.11	1.11	118 92339	118 90014	–	118 90002
	<b>47</b>	<b>18 × 30</b>	<b>03</b>	390	61	23	0.046	1.48	0.60	<b>118 92479</b>	–	–	<b>118 90003</b>
	68	18 × 38	04	500	86	31	0.046	1.02	0.42	118 92689	–	–	118 90004
	<b>100</b>	<b>21 × 38</b>	<b>05</b>	610	124	44	0.046	0.96	0.39	<b>118 92101</b>	–	–	<b>118 90005</b>

# Aluminum electrolytic capacitors

## Axial High Temperature

118 AHT

### Additional electrical data

PARAMETER	CONDITIONS	VALUE	
		AXIAL	MOUNTING RING
<b>Voltage</b>			
Surge voltage		$U_S \leq 1.15 \times U_R$	
Reverse voltage		$U_{rev} \leq 1 V$	
<b>Current</b>			
Leakage current	after 1 minute at $U_R$	$I_{L1} \leq 0.006C_R \times U_R + 4 \mu A$ or $20 \mu A$ (whichever is greater)	
	after 5 minutes at $U_R$	$I_{L5} \leq 0.002C_R \times U_R + 4 \mu A$	
<b>Inductance</b>			
Equivalent series inductance (ESL)	case $\varnothing D \times L$ mm:		
	6.5 × 18	typ. 15 nH	–
	8 × 18	typ. 35 nH	–
	10 × 18	typ. 69 nH	–
	10 × 25	typ. 38 nH	–
	10 × 30	typ. 38 nH	–
	12.5 × 30	typ. 46 nH	–
	15 × 30	typ. 48 nH	typ. 39 nH
	18 × 30	typ. 50 nH	typ. 39 nH
	18 × 38	typ. 54 nH	typ. 39 nH
21 × 38	typ. 59 nH	typ. 39 nH	

**Table 4** Uprating values at reduced ambient temperature; note 1

SYMBOL	CONDITIONS	VALUES								UNIT
		6.3	10	16	25	40	63	100	200	
$U_R$	$T_{amb} > 85$ to $125$ °C	6.3	10	16	25	40	63	100	200	V
$U_{R2}$	$T_{amb} \leq 85$ °C	10	16	25	40	63	100	125	250	V

### Note

- For applications at ambient temperatures of  $\leq 85$  °C, the rated voltage ( $U_R$ ) may be raised to  $U_{R2}$ .

### MARKING

The capacitors are marked (where possible) with the following information:

- Rated capacitance (in  $\mu F$ )
- Tolerance on rated capacitance, code letter in accordance with "IEC 60062"
- Rated voltage (in V) at 125 °C and 85 °C
- Group number (118)
- Name of manufacturer
- Date code, in accordance with "IEC 60062"
- Code indicating factory of origin
- Band to identify the negative terminal
- '+' sign to identify the positive terminal.

# Aluminum electrolytic capacitors

## Axial High Temperature

118 AHT

Capacitance (C)

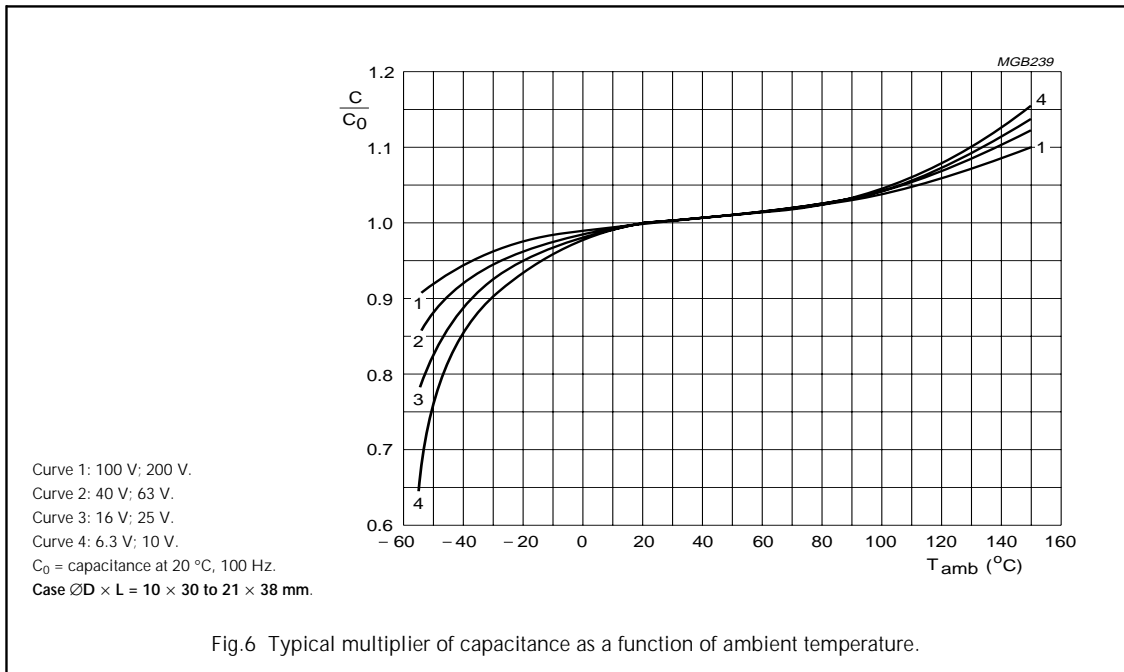
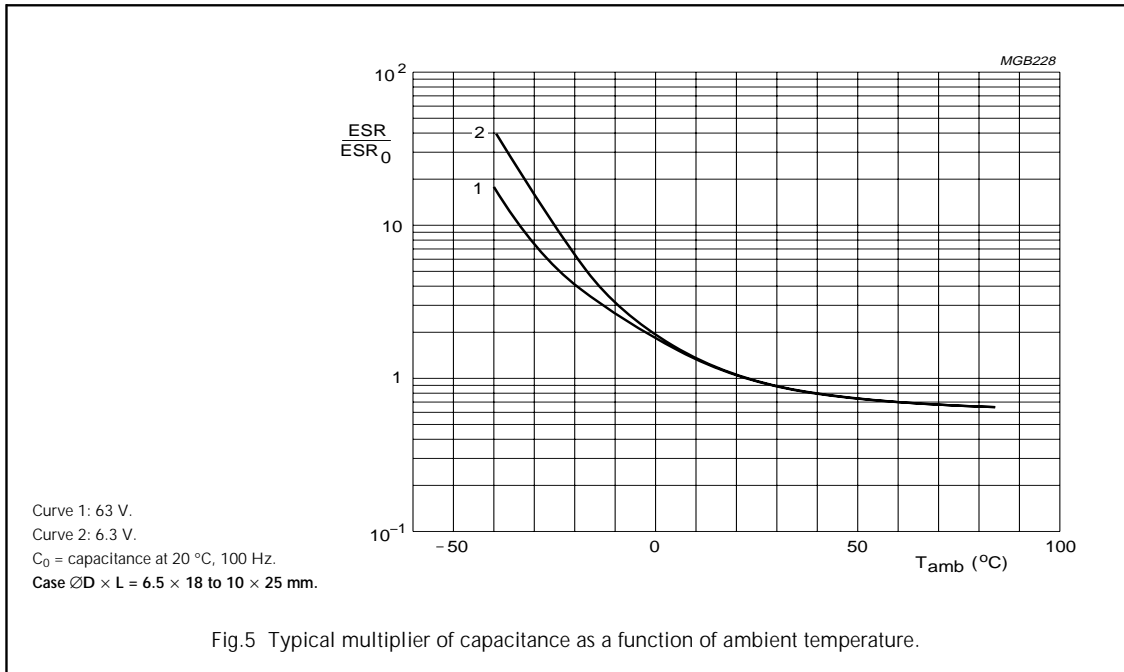

# Aluminum electrolytic capacitors

## Axial High Temperature

118 AHT

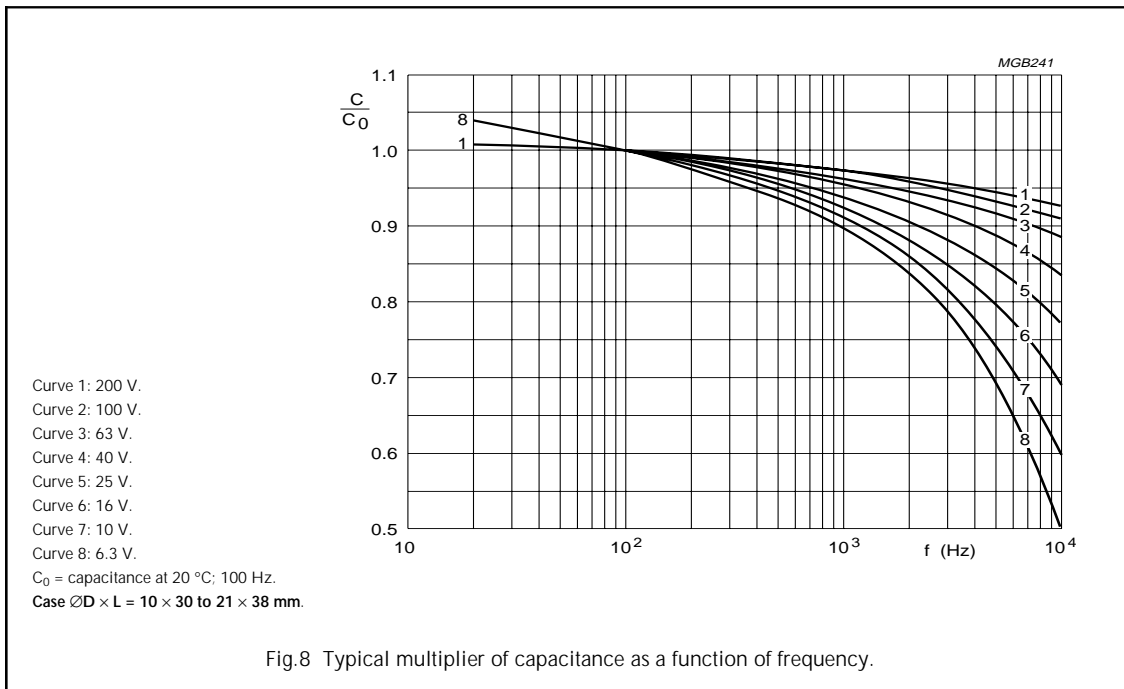
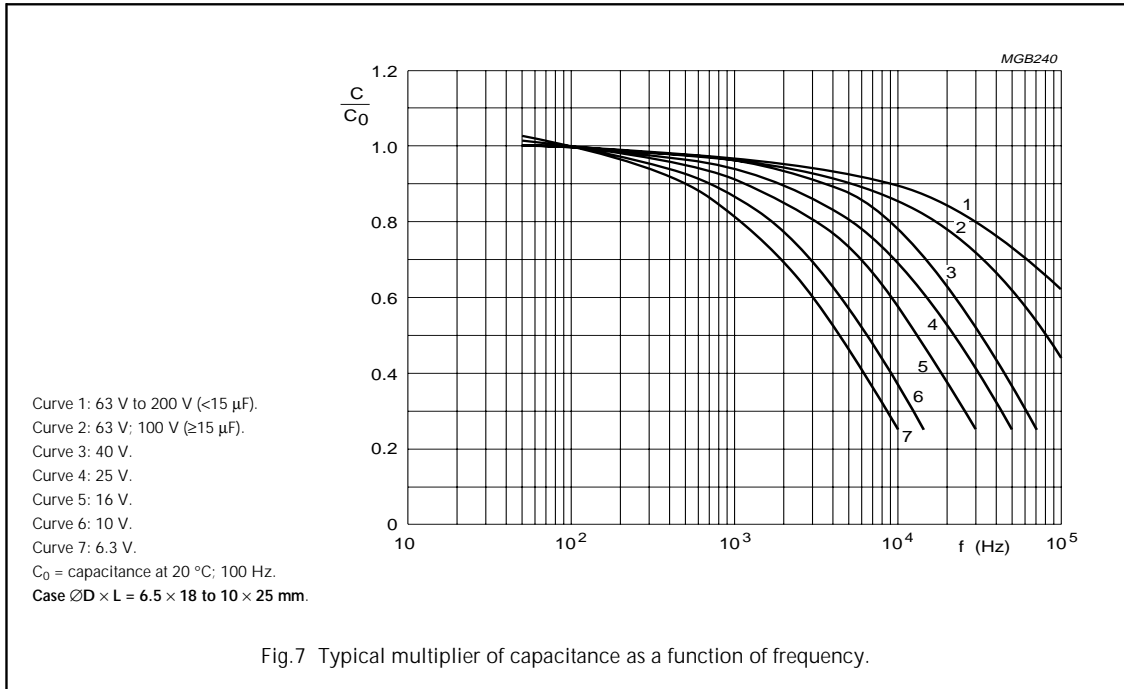

# Aluminum electrolytic capacitors

## Axial High Temperature

118 AHT

### Equivalent series resistance (ESR)

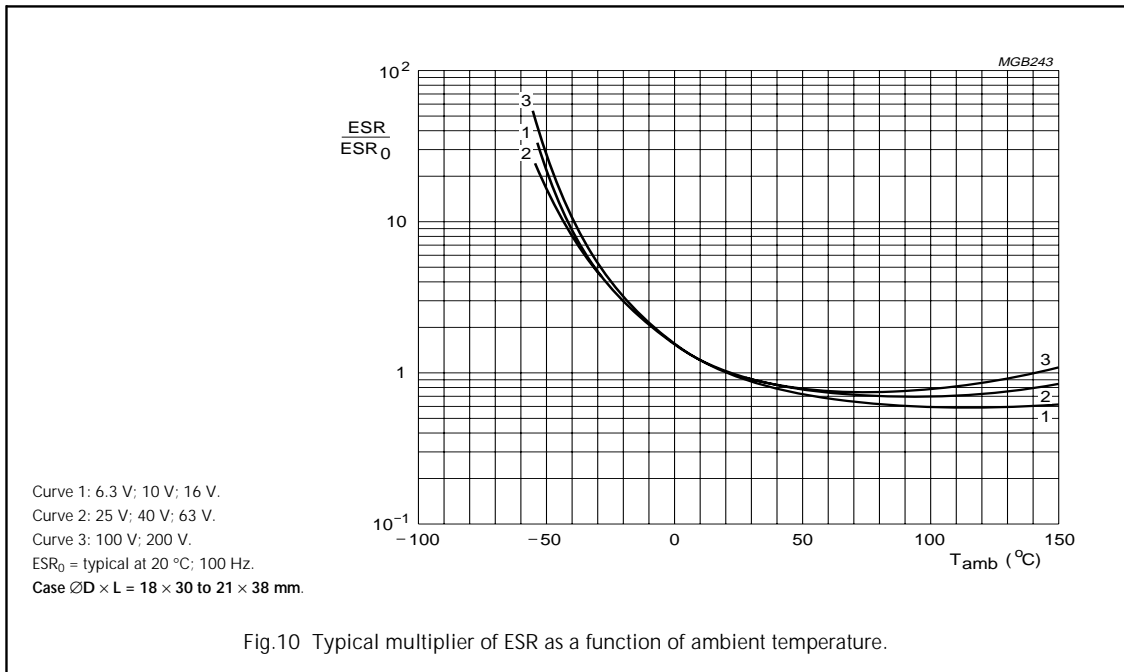
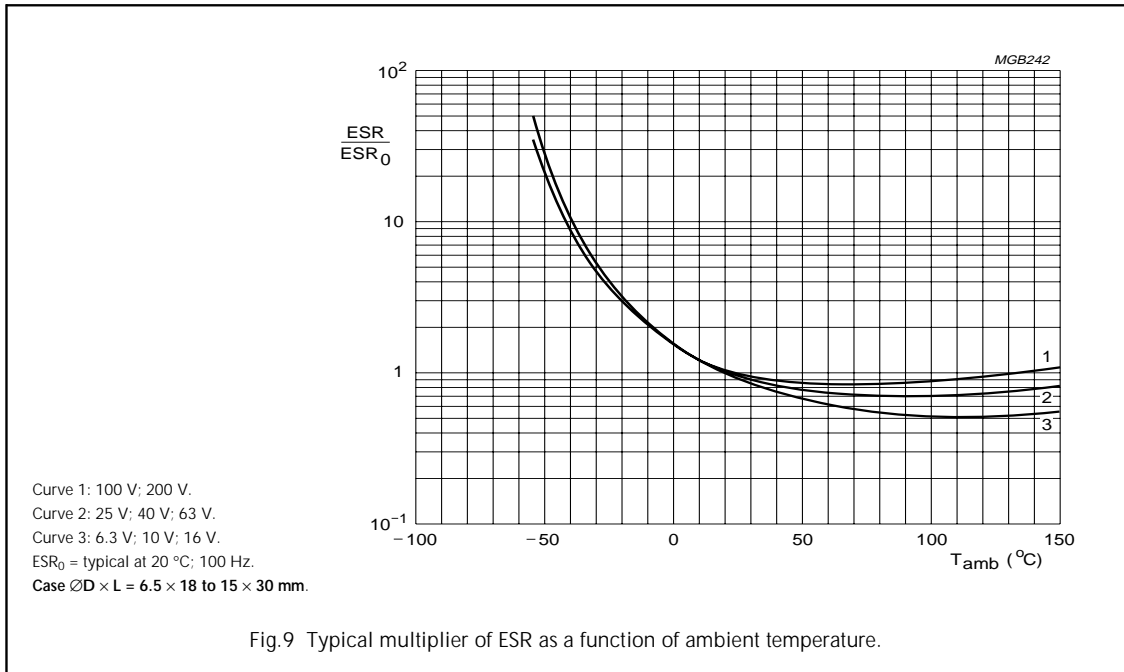

# Aluminum electrolytic capacitors

## Axial High Temperature

118 AHT

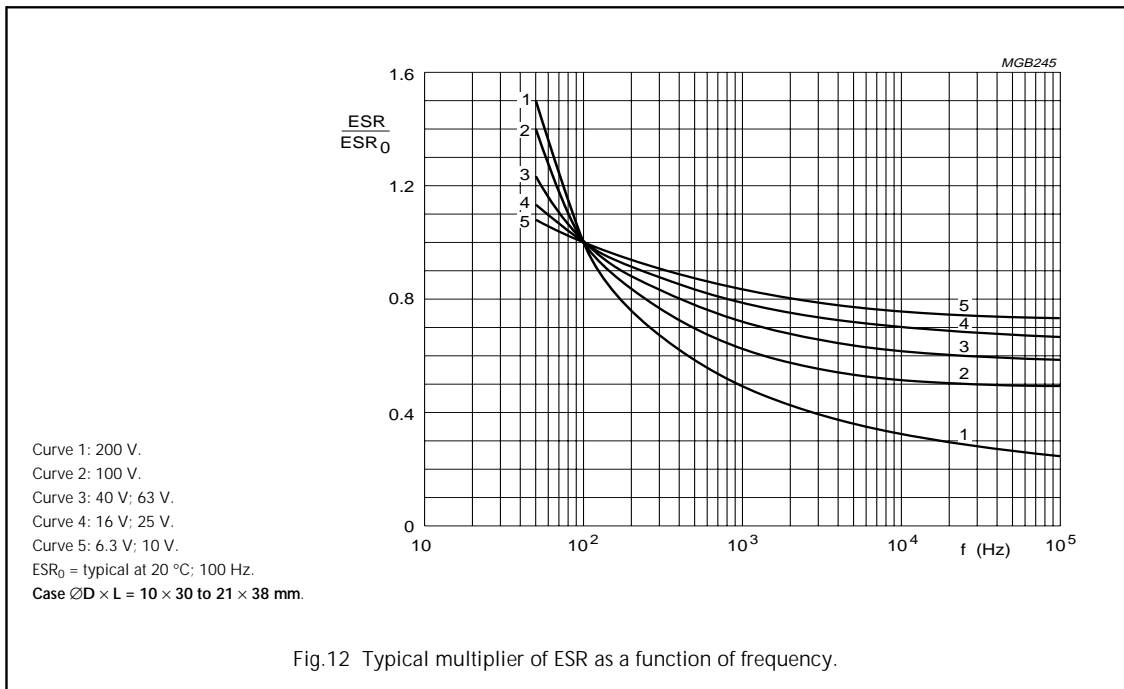
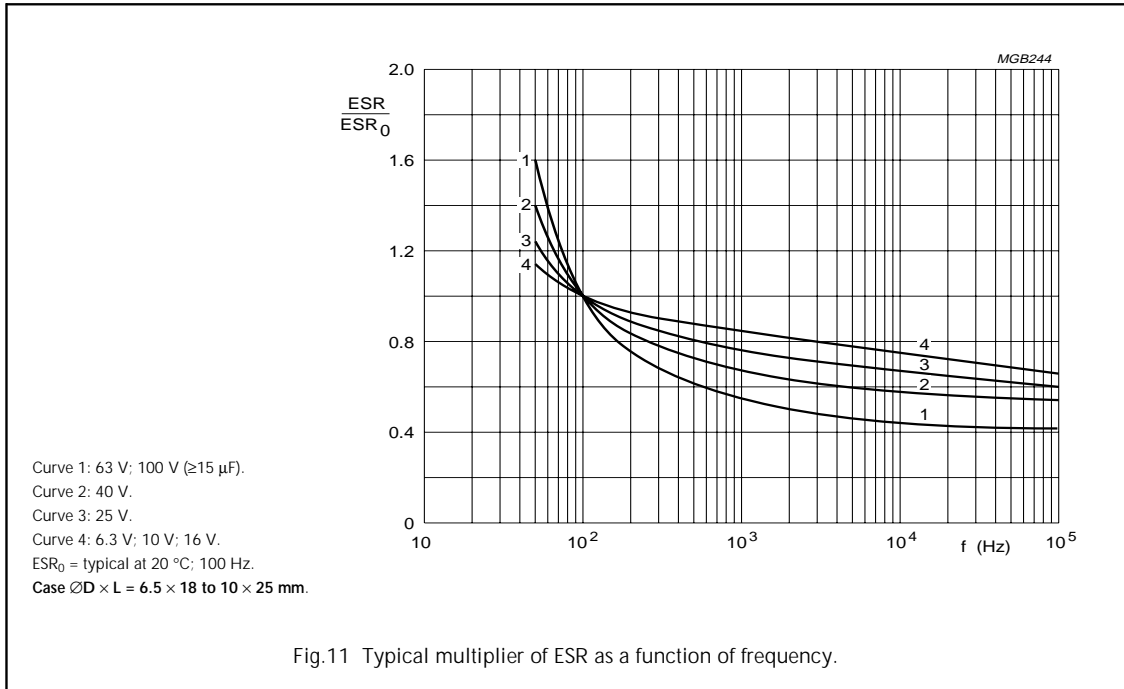

# Aluminum electrolytic capacitors

## Axial High Temperature

118 AHT

Impedance (Z)

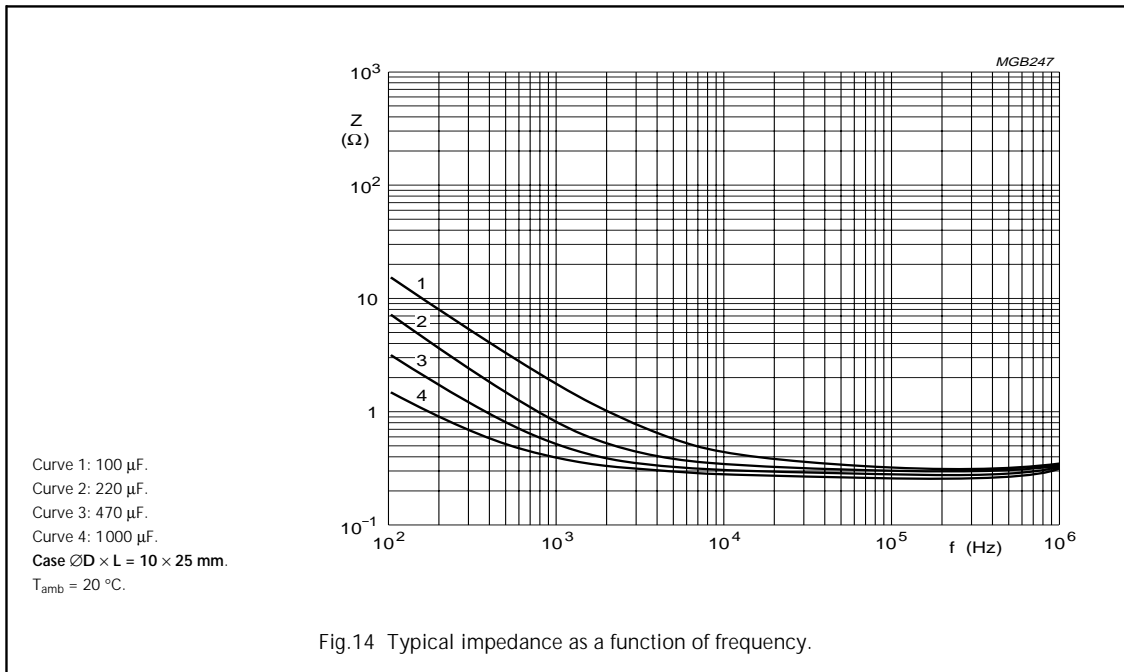
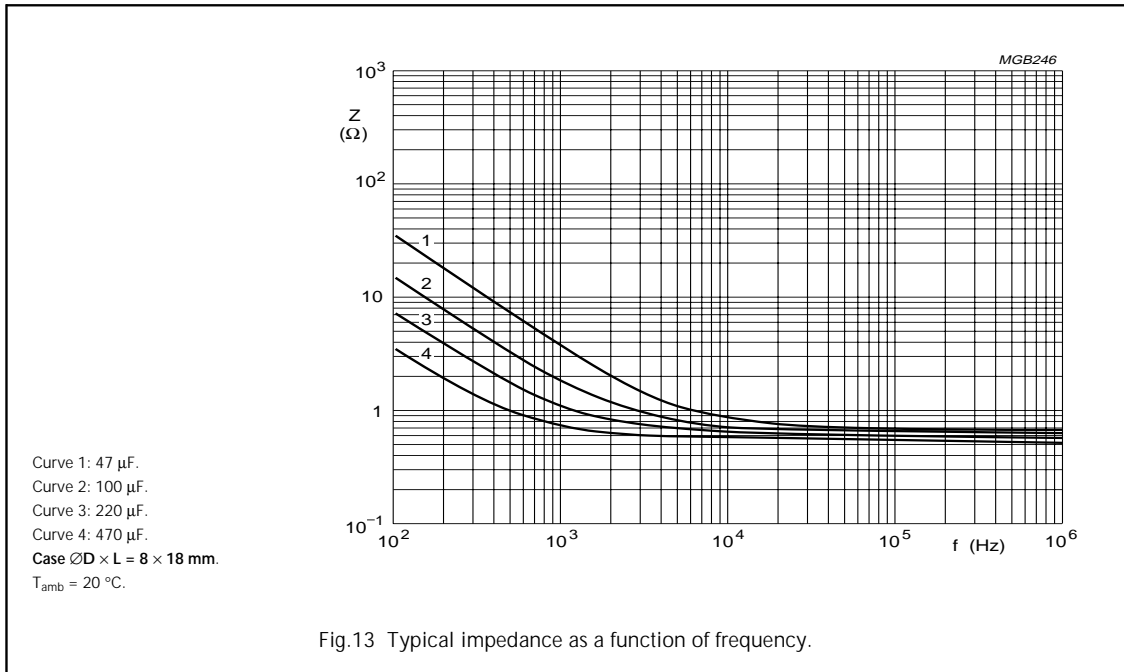

# Aluminum electrolytic capacitors

## Axial High Temperature

118 AHT

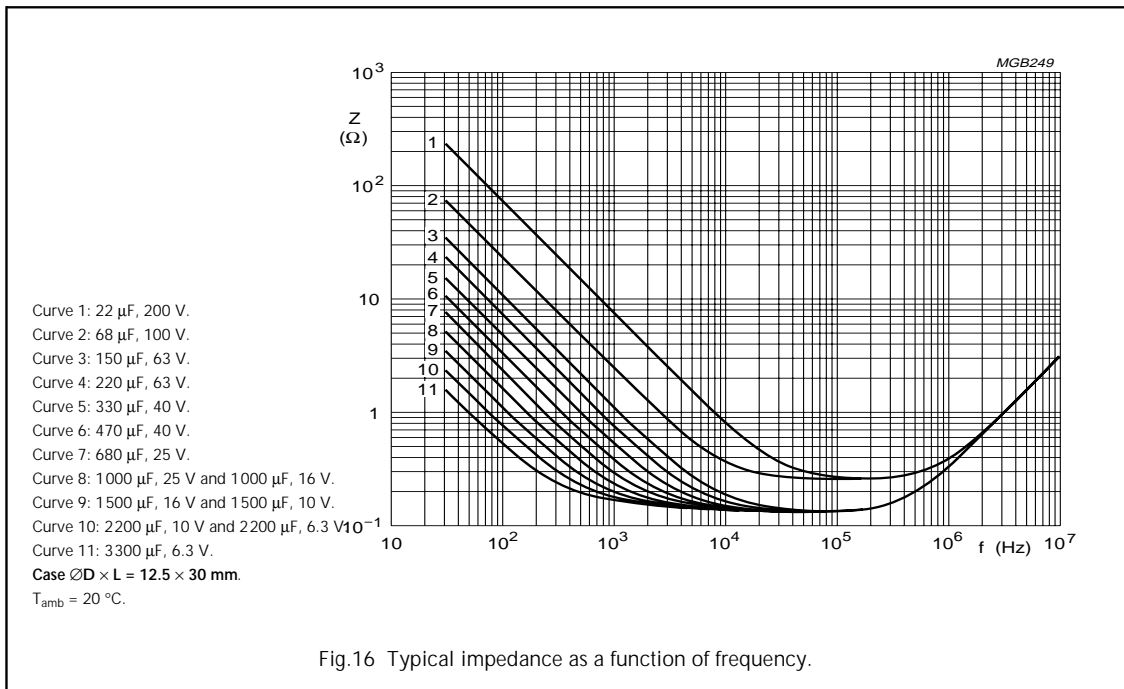
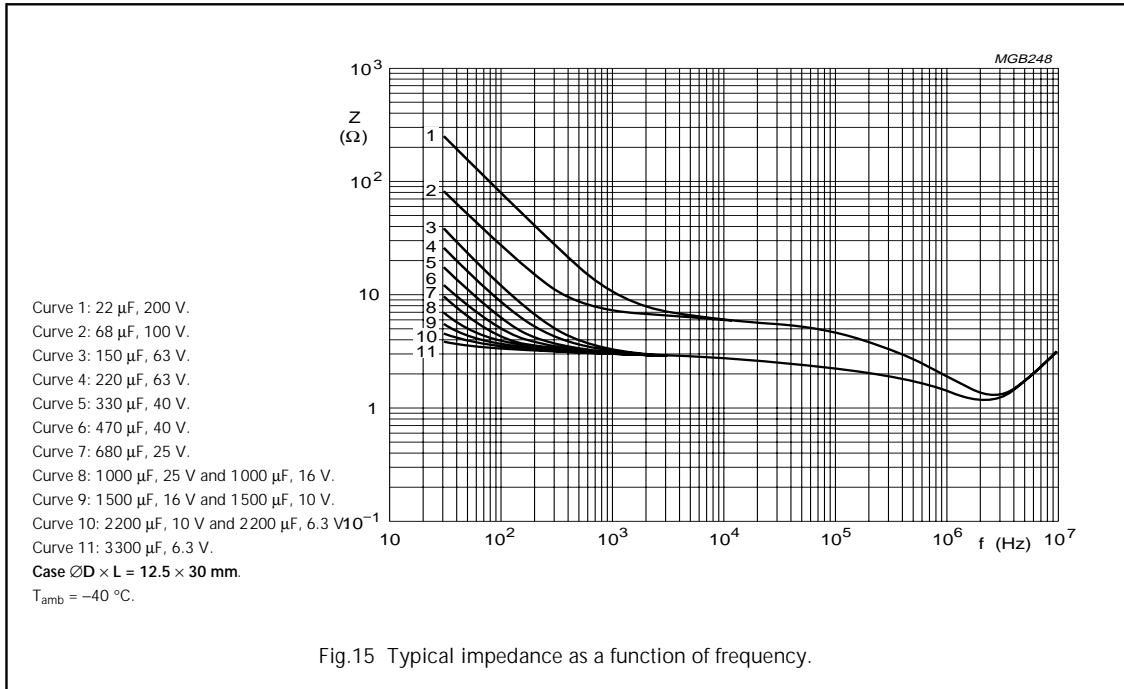



# Aluminum electrolytic capacitors

## Axial High Temperature

118 AHT

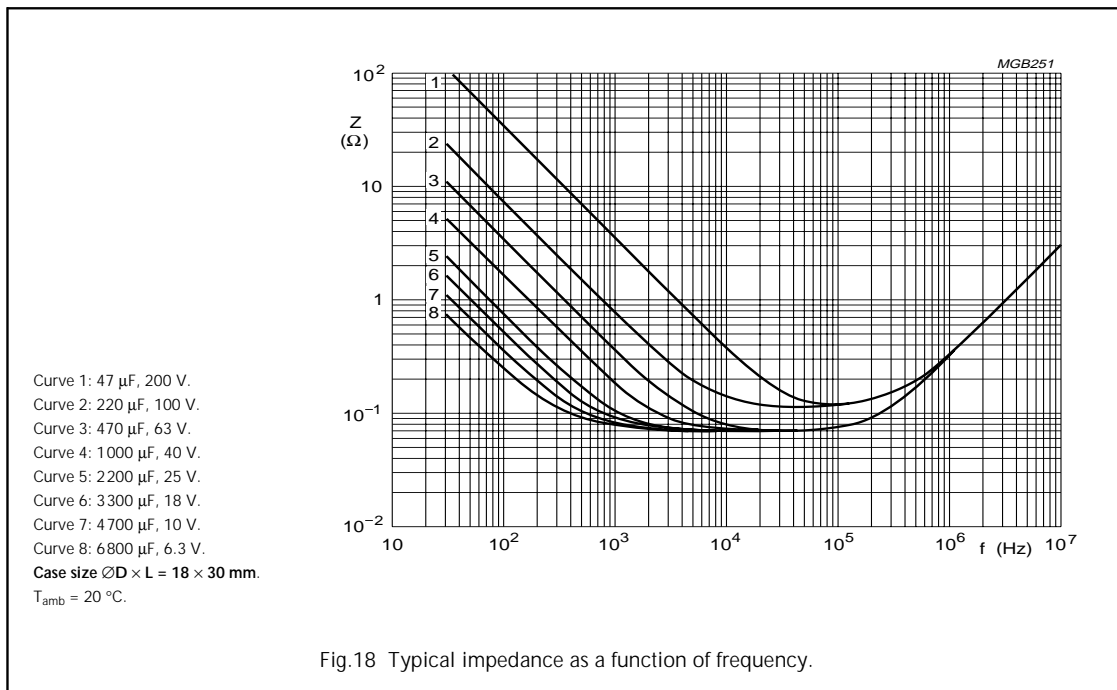
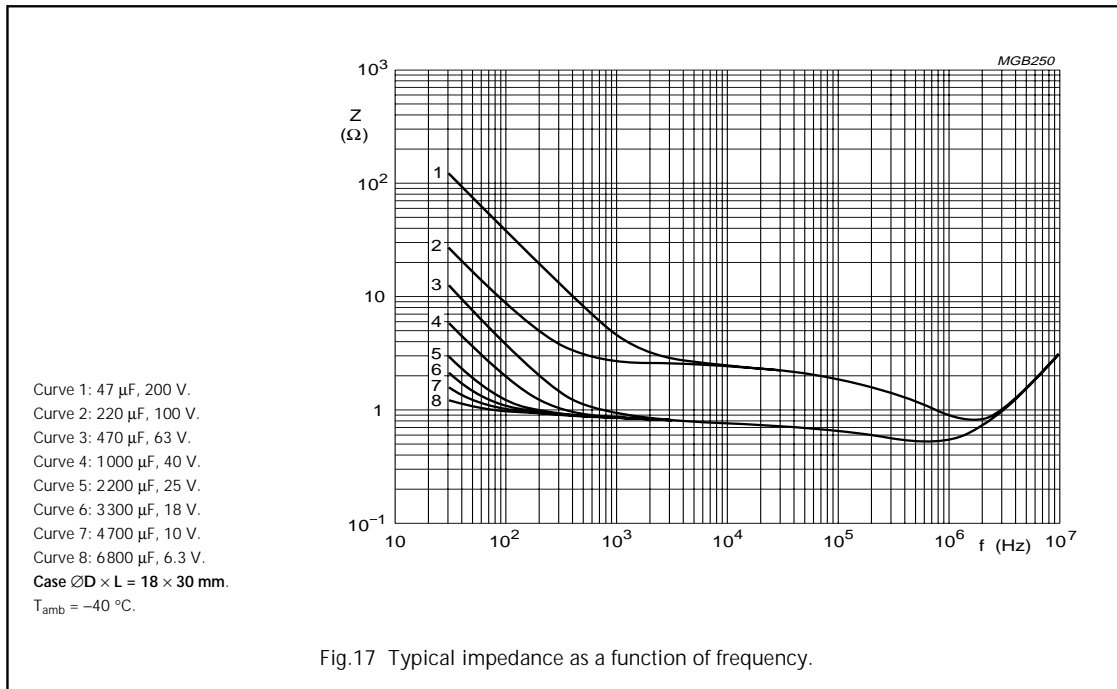

# Aluminum electrolytic capacitors

## Axial High Temperature

118 AHT

### RIPPLE CURRENT AND USEFUL LIFE

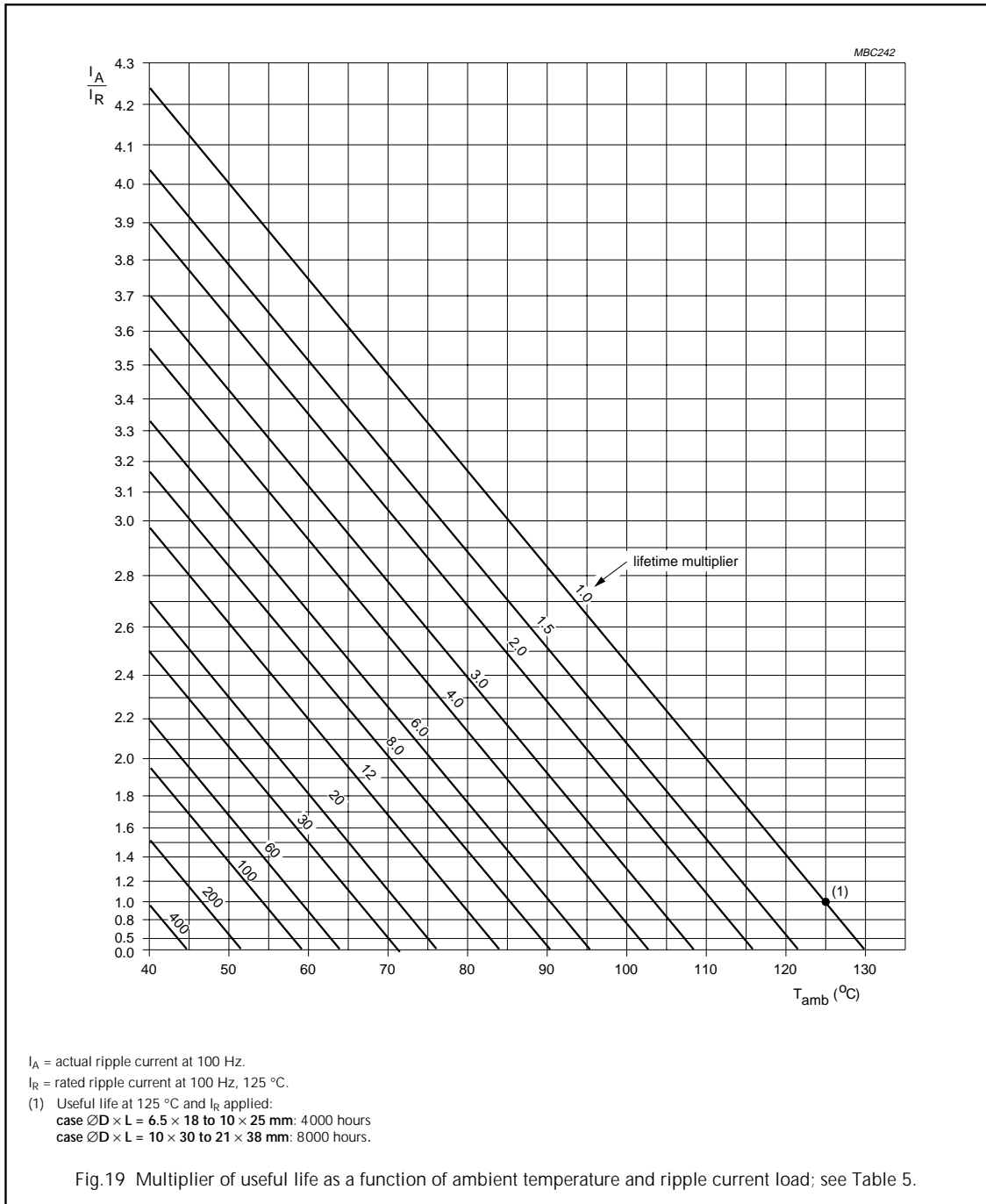

Fig.19 Multiplier of useful life as a function of ambient temperature and ripple current load; see Table 5.

# Aluminum electrolytic capacitors

## Axial High Temperature

118 AHT

**Table 5** Multiplier of ripple current ( $I_R$ ) as a function of frequency

FREQUENCY (Hz)	$I_R$ MULTIPLIER		
	$U_R = 6.3$ to $25$ V	$U_R = 40$ to $63$ V	$U_R = 100$ to $200$ V
50	0.95	0.9	0.85
100	1.0	1.0	1.0
300	1.07	1.12	1.2
1000	1.12	1.2	1.3
3000	1.15	1.25	1.35
$\geq 10000$	1.2	1.3	1.4

### SPECIFIC TESTS AND REQUIREMENTS

General tests and requirements are specified in data handbook BC01, section "Tests and Requirements".

**Table 6** Test procedures and requirements

TEST		PROCEDURE (quick reference)	REQUIREMENTS
NAME OF TEST	REFERENCE		
Endurance	IEC 60384-4/ EN130300 subclause 4.13	$T_{amb} = 125$ °C; $U_R$ applied; case sizes: 6.5 × 18 to 10 × 25 mm: 2000 hours; 10 × 30 to 21 × 38 mm: 3000 hours	$U_R \leq 6.3$ V; $\Delta C/C$ : +15/–30% $U_R > 6.3$ V; $\Delta C/C$ : $\pm 15\%$ $\tan \delta \leq 1.3 \times$ spec. limit $Z \leq 2 \times$ spec. limit $I_{L5} \leq$ spec. limit
Useful life	CECC 30301 subclause 1.8.1	$T_{amb} = 125$ °C; $U_R$ and $I_R$ applied; case $\varnothing D \times L = 6.5 \times 18$ to $10 \times 25$ mm: 4000 hours; case $\varnothing D \times L = 10 \times 30$ to $21 \times 38$ mm: 8000 hours	$U_R \leq 6.3$ V; $\Delta C/C$ : +45/–50% $U_R > 6.3$ V; $\Delta C/C$ : $\pm 45\%$ $\tan \delta \leq 3 \times$ spec. limit $Z \leq 3 \times$ spec. limit $I_{L5} \leq$ spec. limit no short or open circuit total failure percentage: $\leq 1\%$ (200 V $\leq 3\%$ )
Shelf life (storage at high temperature)	IEC 60384-4/ EN130300 subclause 4.17	$T_{amb} = 125$ °C; no voltage applied; $U_R = 6.3$ to $63$ V: 500 hours; $U_R = 100$ and $200$ V: 100 hours  after test: $U_R$ to be applied for 30 minutes, 24 to 48 hours before measurement	$\Delta C/C$ , $\tan \delta$ , $Z$ : for requirements see 'Endurance test' above $I_{L5} \leq 2 \times$ spec. limit
Reverse voltage	IEC 60384-4/ EN130300 subclause 4.15	$T_{amb} = 125$ °C: 125 hours at $U = -1$ V followed by 125 hours at $U_R$	$\Delta C/C$ : $\pm 20\%$ $\tan \delta \leq$ spec. limit $I_{L5} \leq$ spec. limit