



DESCRIPTION

The SDT1600 combines four independent optocouplers in a 16 pin DIP/SMD package. Each of the four optocoupler circuits is composed of an input LED optically-coupled to a Phototransistor--allowing for high isolation levels while maintaining low-level DC signal control capability. The SDT1600 provides an optically isolated method of controlling many interface applications such as telecommunications, industrial control and instrumentation circuitry.

FEATURES

- High input-to-output isolation package (5000 Vrms)
- Low input power consumption
- High stability

APPLICATIONS

- Loop current detection
- Ring signal detection, Computer terminals, Programmable controls.
- Power supply feedback isolation, Laser beam printer.
- Audio signal interface, System appliances, measuring instruments.
- Transformer replacement, registers, copiers etc.

OPTIONS/SUFFIXES

- -H High input-to-output isolation voltage (5000Vrms)
- -S Surface Mount Option
- -TR Tape and Reel Option

MAXIMUM RATINGS

PARAMETER	UNIT	MIN	TYP	MAX
Storage Temperature	°C	-55		125
Operating Temperature	°C	-40		100
Continuous Input Current	mA			50
Transient Input Current	A			1
Reverse Voltage	V			6
Output Power Dissipation	mW			200

SCHEMATIC DIAGRAM

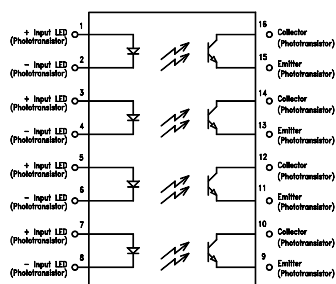

APPROVALS

- UL and C-UL Approved File #E201932

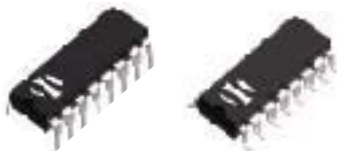

DC Input
Quad Optocoupler

ELECTRICAL CHARACTERISTICS - 25°

PARAMETER	UNIT	MIN	TYP	MAX	TEST CONDITIONS
INPUT SPECIFICATIONS					
LED Forward Voltage	V		1.2	1.4	If = 20mA
LED Reverse Current	uA			10	Vr = 4V
OUTPUT SPECIFICATIONS					
Collector-Emitter Breakdown Voltage	V	60			Ic = 10uA
Emitter-Collector Breakdown Voltage	V	6			Ie = 1uA
Dark Current	uA			0.1	Vce = 20V
Floating Capacitance	p F		0.6	1	V= 0V, f=1.0MHz
Saturation Voltage	V		0.1	0.2	If = 20mA, Ic = 1mA
Current Transfer Ratio	%	50		600	If = 5mA, Vce = 5V
Rise Time	μ s		3		Ic = 2mA, Vce = 2V, Rc= 100 ohms
Fall Time	μ s		5		Ic= 2mA, Vce = 2V, Rc = 100 ohms
COUPLED SPECIFICATIONS					
Isolation Voltage	V	5000			T = 1 minute
Cut-Off-Frequency	kHz		80		Vcc=5V, Ic=2mA, Rc=100 ohms
Isolation Resistance	G Ω	50			

DC Input Quad Optocoupler



Fig.1 Current Transfer Ratio vs. Forward Current

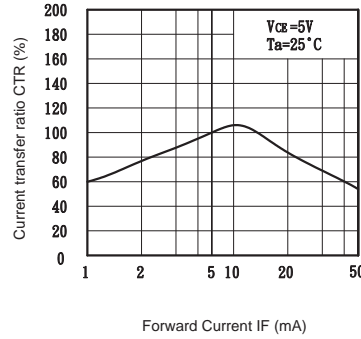

Fig.2 Collector Power Dissipation vs. Ambient Temperature

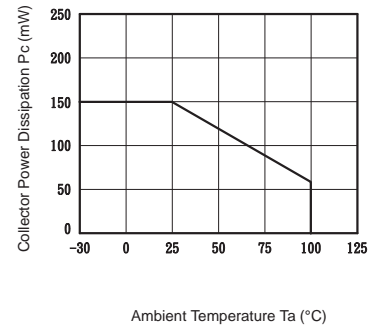

Fig.3 Collector Dark Current vs. Ambient Temperature

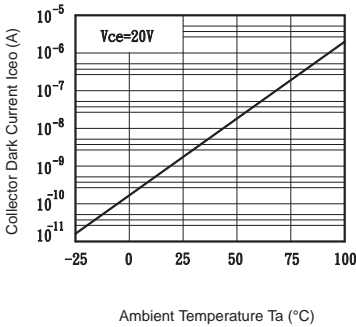

Fig.4 Forward Current vs. Ambient Temperature

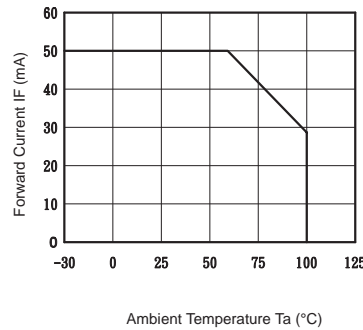

Fig.5 Forward Current vs. Forward Voltage

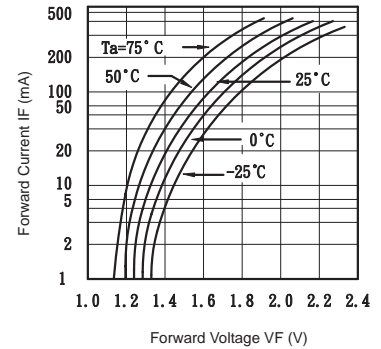

Fig.6 Collector Current vs. Collector-emitter Voltage

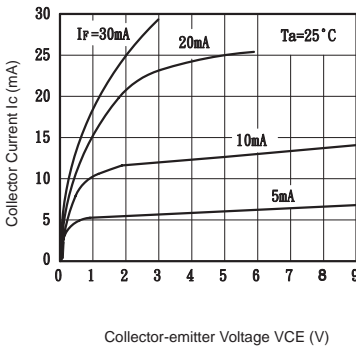

Fig.7 Relative Current Transfer Ratio vs. Ambient Temperature

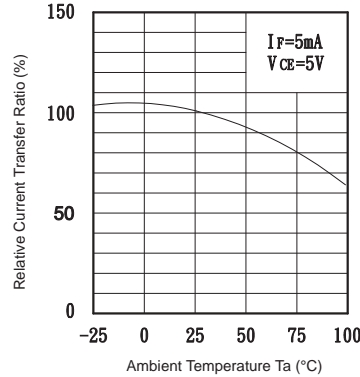

Fig.8 Collector-emitter Saturation Voltage vs. Ambient Temperature

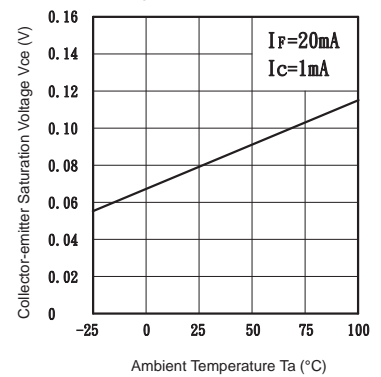

Fig.9 Collector-emitter Saturation Voltage vs. Forward Current

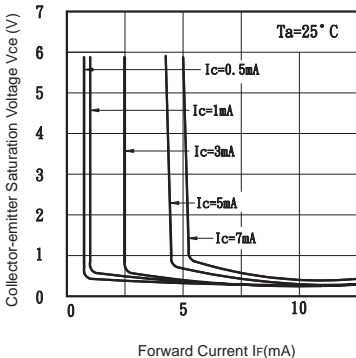

Fig.10 Response Time vs. Load Resistance

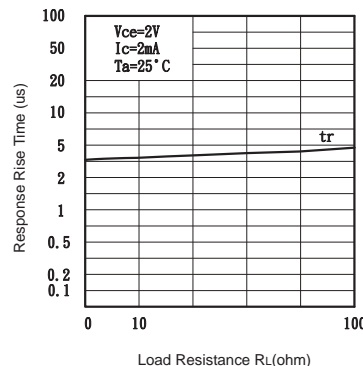
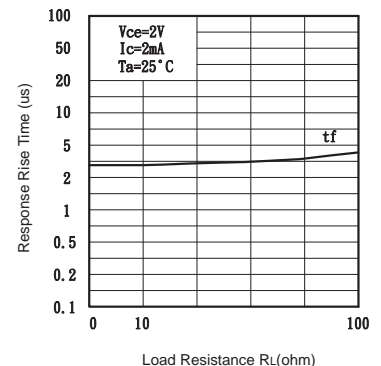

Fig.11 Response Time vs. Load Resistance



DC Input
Quad Optocoupler



MECHANICAL DIMENSIONS

16 PIN DUAL IN-LINE PACKAGE

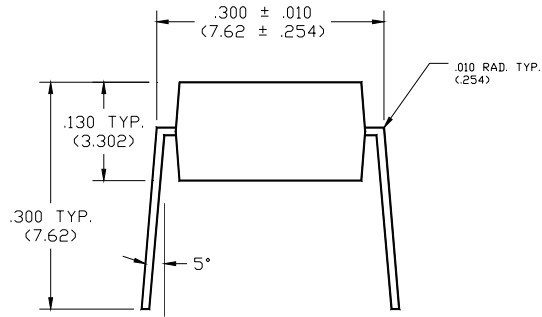

END VIEW

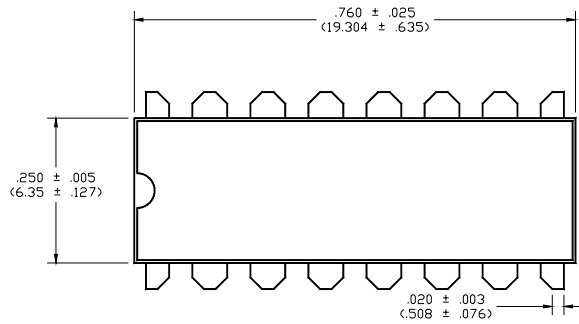

TOP VIEW

16 PIN SURFACE MOUNT DEVICE

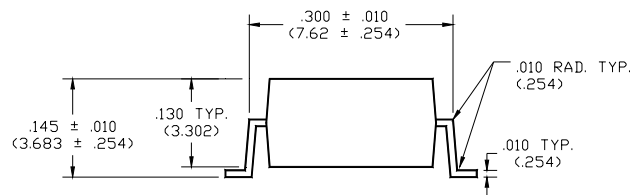

END VIEW

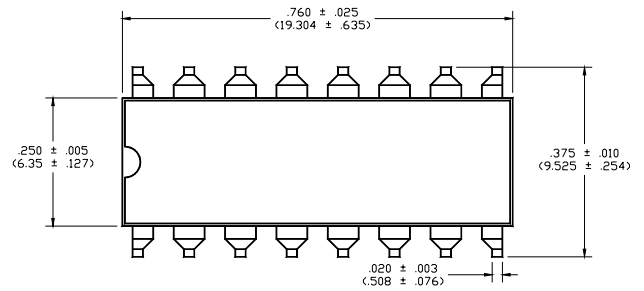

TOP VIEW