

P/N: SA08-11SRWA

SUPER BRIGHT RED

### Features

- 0.8 INCH DIGIT HEIGHT.
- LOW CURRENT OPERATION.
- EXCELLENT CHARACTER APPEARANCE.
- EASY MOUNTING ON P.C. BOARDS OR SOCKETS.
- I.C. COMPATIBLE.
- CATEGORIZED FOR LUMINOUS INTENSITY.
- MECHANICALLY RUGGED.
- STANDARD : GRAY FACE, WHITE SEGMENT.
- RoHS COMPLIANT.

### Description

The Super Bright Red source color devices are made with Gallium Aluminum Arsenide Red Light Emitting Diode.

### Package Dimensions & Internal Circuit Diagram

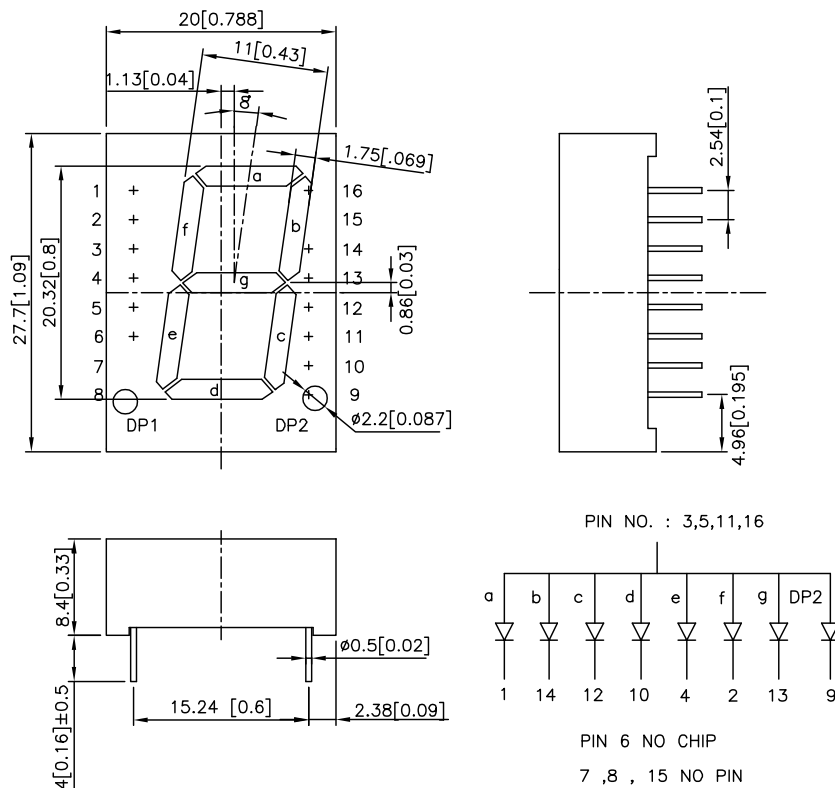

**Notes:**

1. All dimensions are in millimeters (inches), Tolerance is  $\pm 0.25(0.01)$  unless otherwise noted.
2. Specifications are subject to change without notice.

## Selection Guide

| Part No.    | Dice                     | Lens Type      | Iv (ucd)<br>@ 10mA |       | Description                       |
|-------------|--------------------------|----------------|--------------------|-------|-----------------------------------|
|             |                          |                | Min.               | Typ.  |                                   |
| SA08-11SRWA | SUPER BRIGHT RED(GaAlAs) | WHITE DIFFUSED | 4700               | 24000 | Common Anode,Rt.<br>Hand Decimal. |

## Electrical / Optical Characteristics at TA=25°C

| Symbol                | Parameter                | Device           | Typ. | Max. | Units | Test Conditions |
|-----------------------|--------------------------|------------------|------|------|-------|-----------------|
| $\lambda_{peak}$      | Peak Wavelength          | Super Bright Red | 660  |      | nm    | IF=20mA         |
| $\lambda_D$           | Dominant Wavelength      | Super Bright Red | 640  |      | nm    | IF=20mA         |
| $\Delta\lambda_{1/2}$ | Spectral Line Half-width | Super Bright Red | 20   |      | nm    | IF=20mA         |
| C                     | Capacitance              | Super Bright Red | 45   |      | pF    | VF=0V;f=1MHz    |
| VF                    | Forward Voltage          | Super Bright Red | 1.85 | 2.5  | V     | IF=20mA         |
| IR                    | Reverse Current          | Super Bright Red |      | 10   | uA    | VR = 5V         |

## Absolute Maximum Ratings at TA=25°C

| Parameter                     | Super Bright Red    | Units |
|-------------------------------|---------------------|-------|
| Power dissipation             | 100                 | mW    |
| DC Forward Current            | 30                  | mA    |
| Peak Forward Current [1]      | 155                 | mA    |
| Reverse Voltage               | 5                   | V     |
| Operating/Storage Temperature | -40°C To +85°C      |       |
| Lead Solder Temperature [2]   | 260°C For 5 Seconds |       |

Notes:

1. 1/10 Duty Cycle, 0.1ms Pulse Width.
2. 2mm below package base.

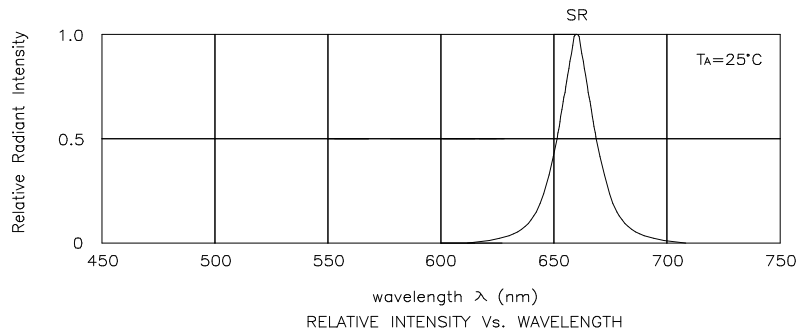

## Super Bright Red

## SA08-11SRWA

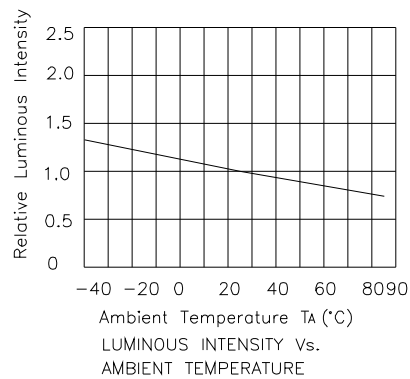
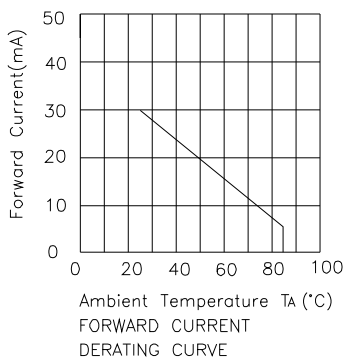
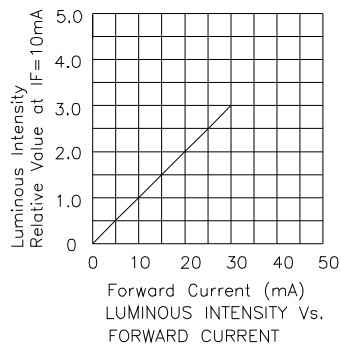
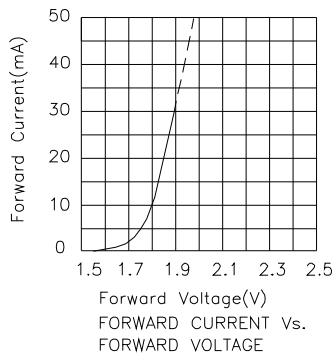

## PACKING & LABEL SPECIFICATIONS

## SA08-11SRWA

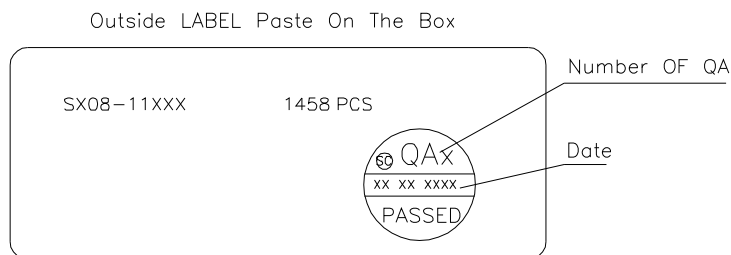
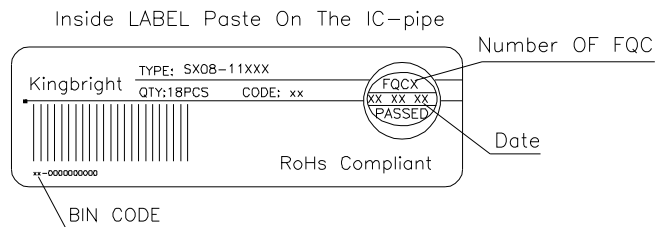
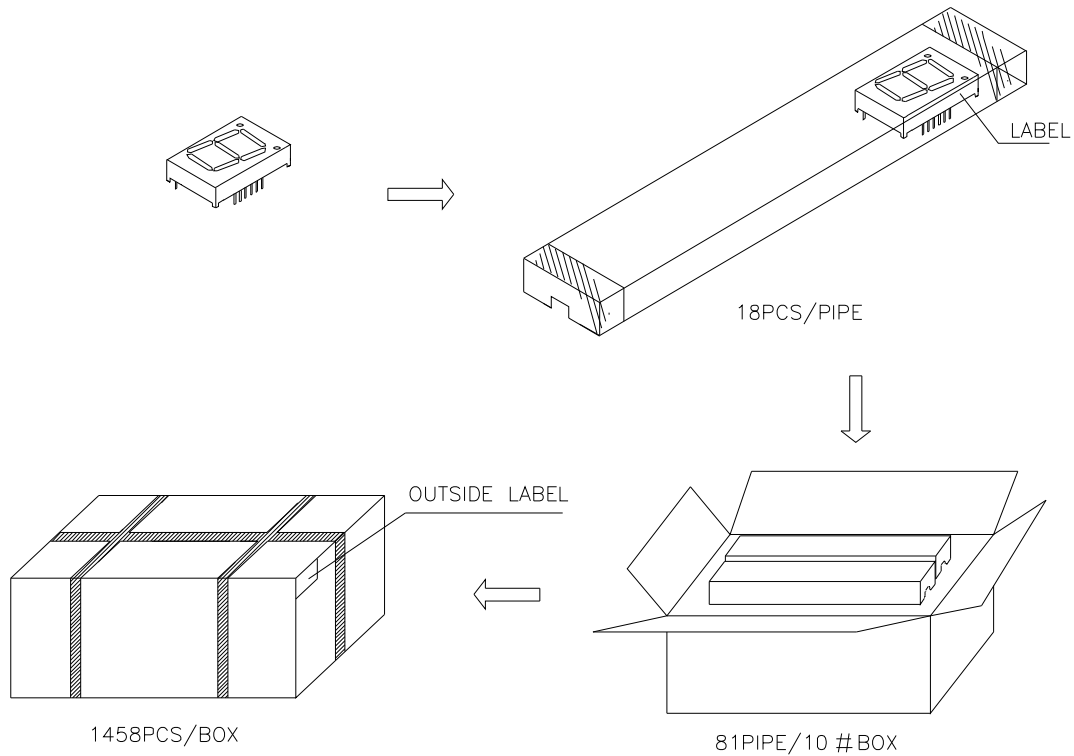

### Remarks:

If special sorting is required (e.g. binning based on forward voltage, Luminous intensity/ luminous flux, or wavelength), the typical accuracy of the sorting process is as follows:

1. Wavelength: +/-1nm
2. Luminous intensity/ luminous flux: +/-15%
3. Forward Voltage: +/-0.1V

Note: Accuracy may depend on the sorting parameters.