

SHINDENGEN

Schottky Rectifiers (SBD)

Dual

S40HC3

30V 40A

OUTLINE DIMENSIONS

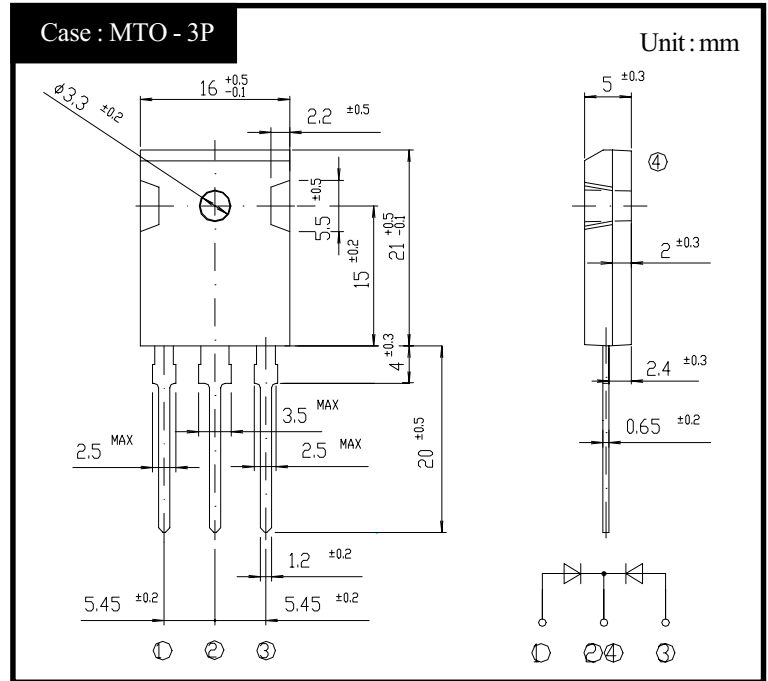

RATINGS

● Absolute Maximum Ratings (Tc=25°C, unless otherwise specified)

Item	Symbol	Conditions	Ratings	Unit
Storage Temperature	Tstg		-55~125	°C
Operating Junction Temperature	Tj		125	°C
Maximum Reverse Voltage	V _{RM}		30	V
Average Rectified Forward Current	I _o	50Hz sine wave, R-load, Rating for each diode I _o /2, Tc=105°C	40	A
Peak Surge Forward Current	I _{FSM}	50Hz sine wave, Non-repetitive 1 cycle peak value, Tj=25°C	400	A
Mounting Torque	TOR	(Recommended torque: 0.5N·m)	0.8	N·m

● Electrical Characteristics (Tc=25°C, unless otherwise specified)

Item	Symbol	Conditions	Ratings	Unit
Forward Voltage	V _F	I _F =20A, Pulse measurement, Rating of per diode	Max 0.4	V
Reverse Current	I _R	V _R =30V, Pulse measurement, Rating of per diode	Max 15	mA
Junction Capacitance	C _j	f=1MHz, V _R =10V, Rating of per diode	Typ 800	pF
Thermal Resistance	θ _{jc}	junction to case	Max 0.7	°C/W

S40HC3 Forward Voltage

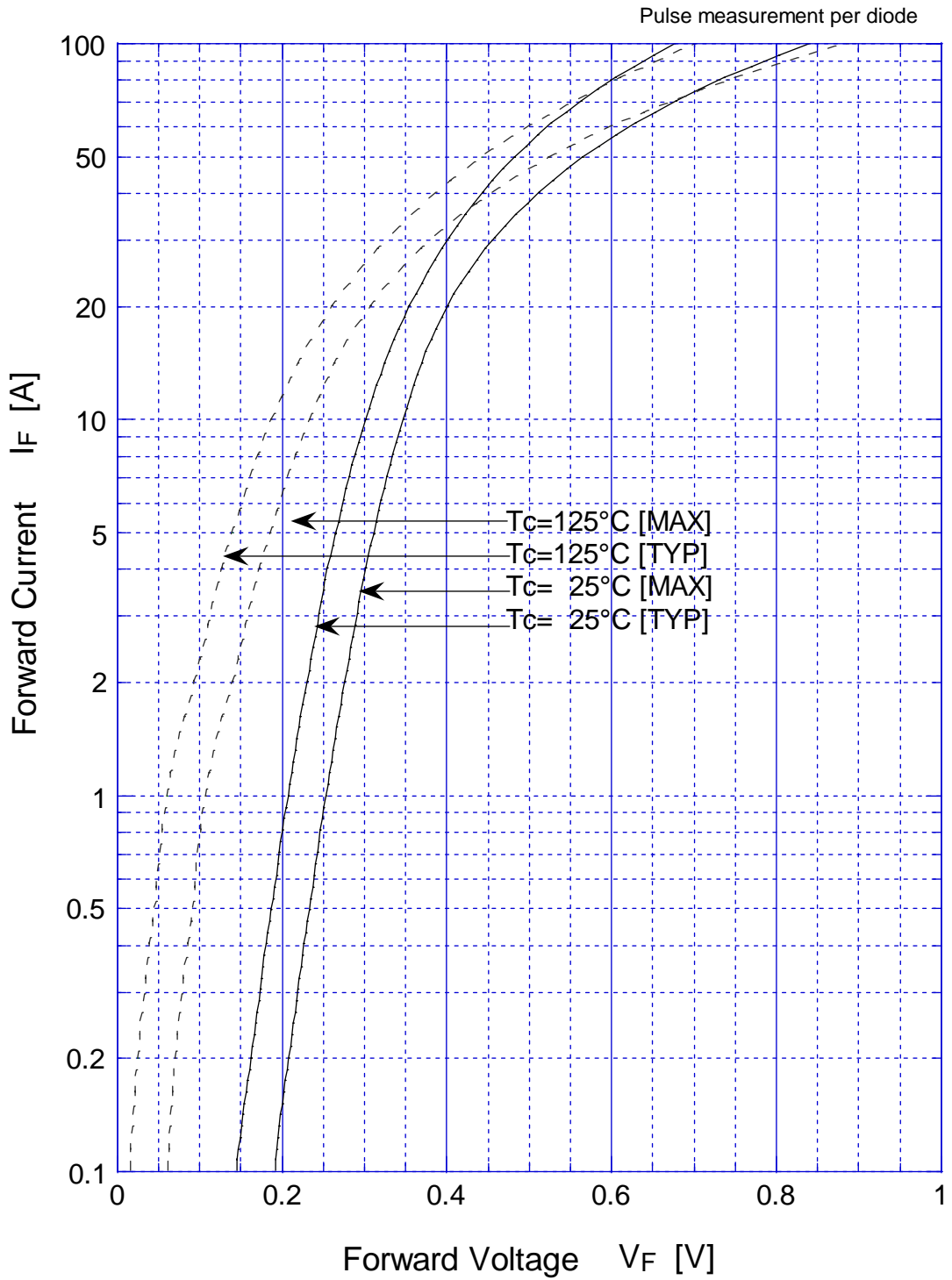

S40HC3 Reverse Current

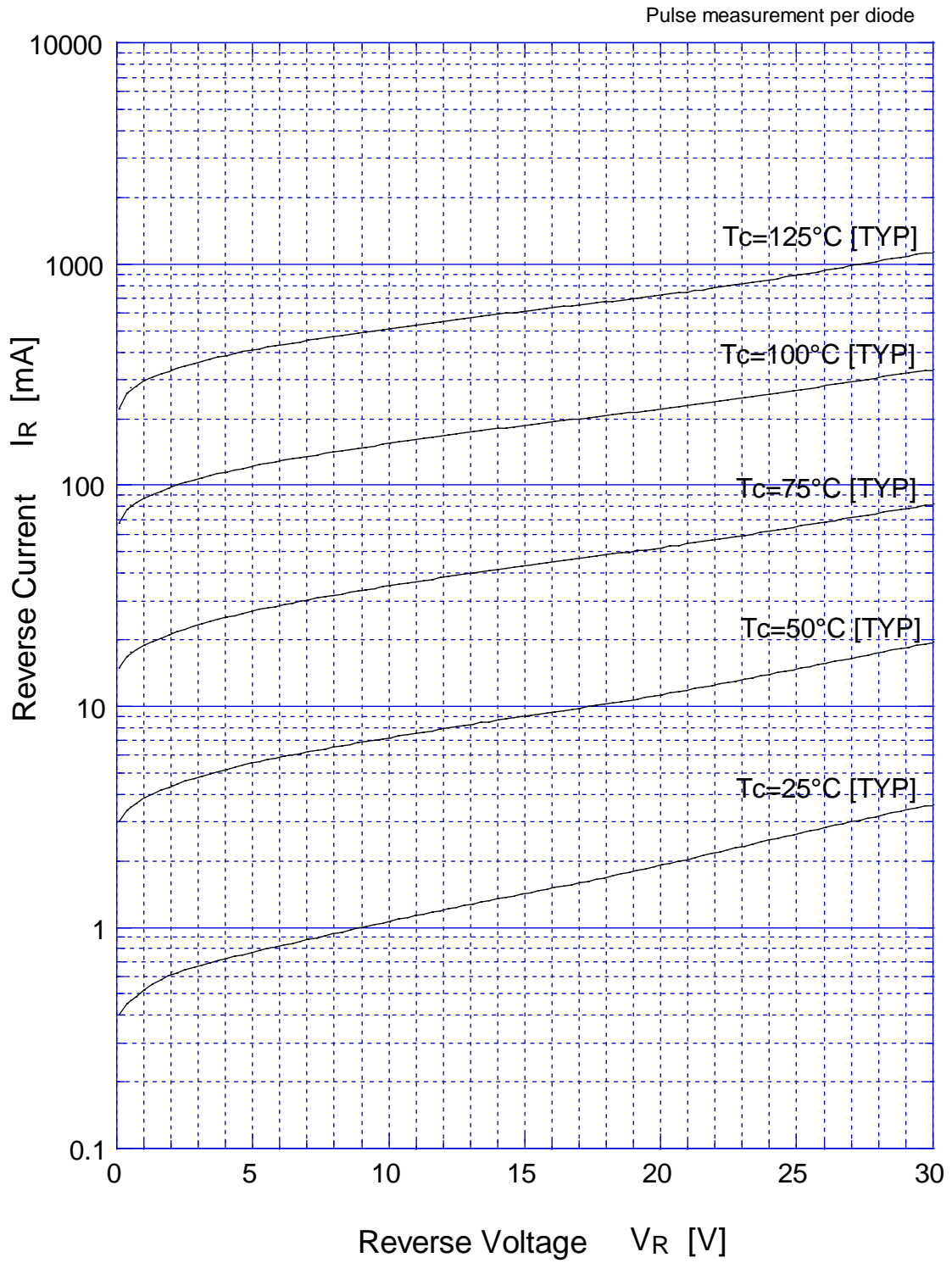

S40HC3 Forward Power Dissipation

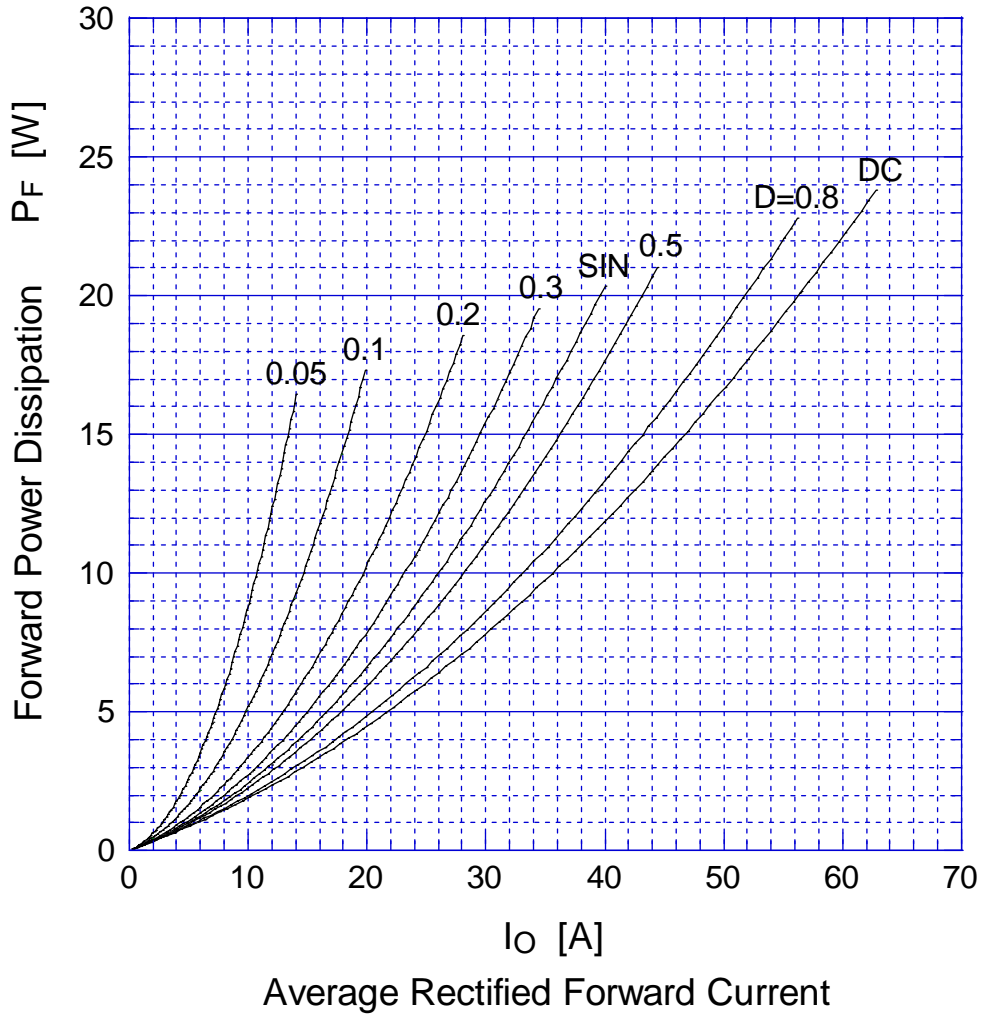

$T_j = 125^\circ\text{C}$

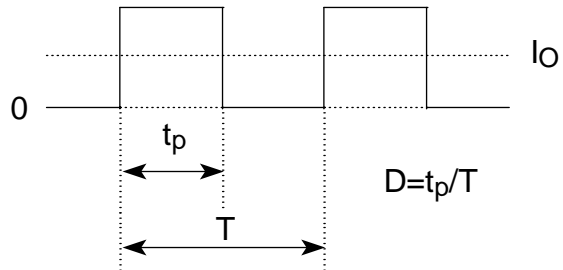

S40HC3 Reverse Power Dissipation

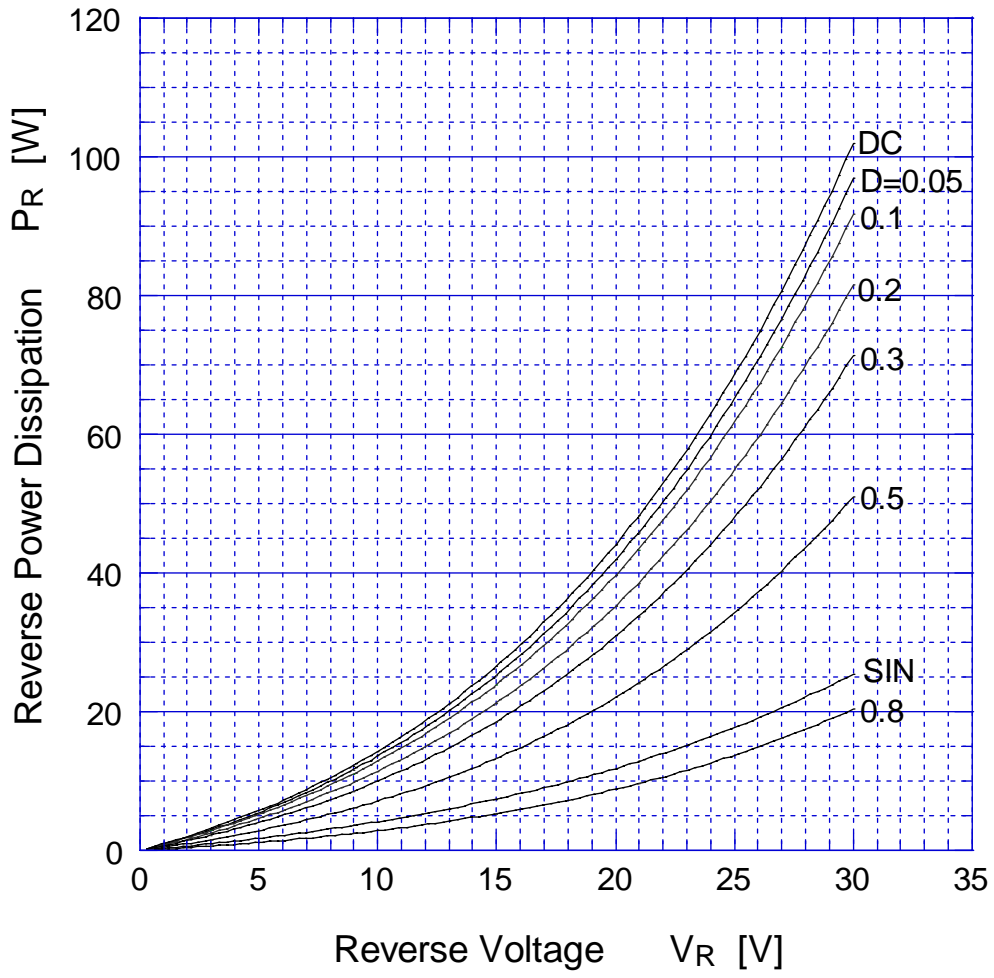

$T_j = 125^\circ\text{C}$

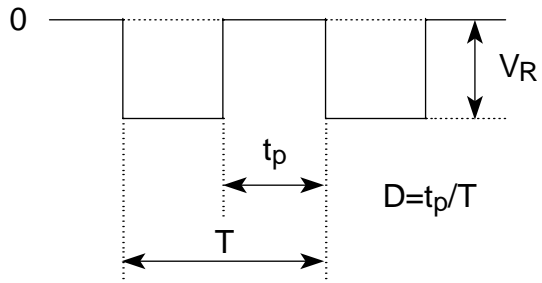

S40HC3

Derating Curve

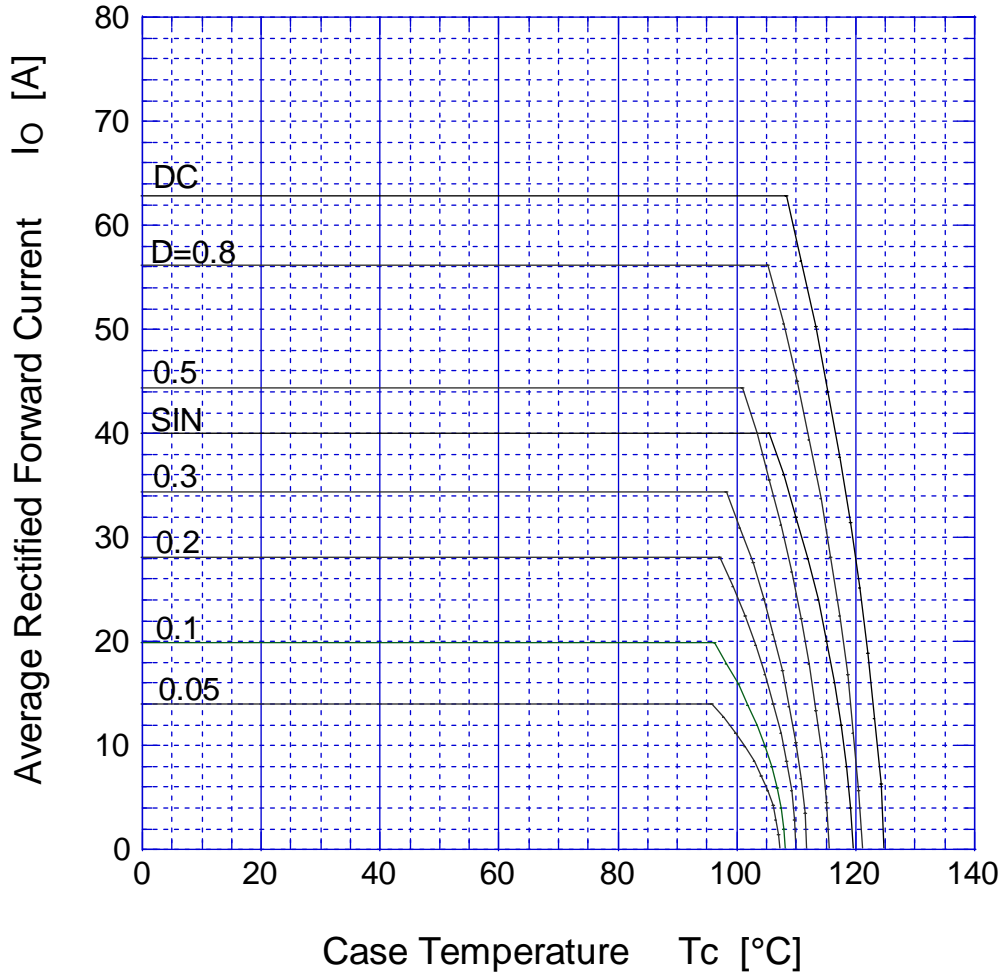

$V_R = 15V$

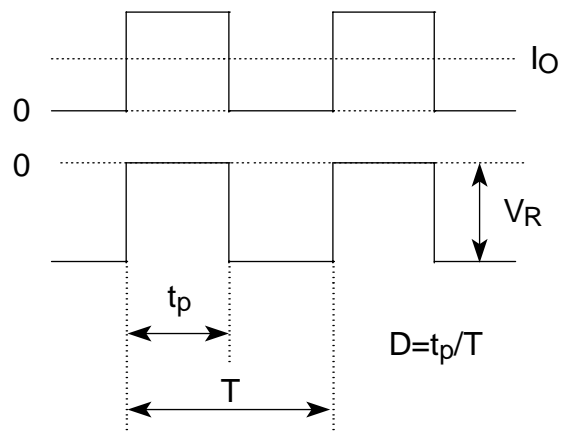

S40HC3 Peak Surge Forward Capability

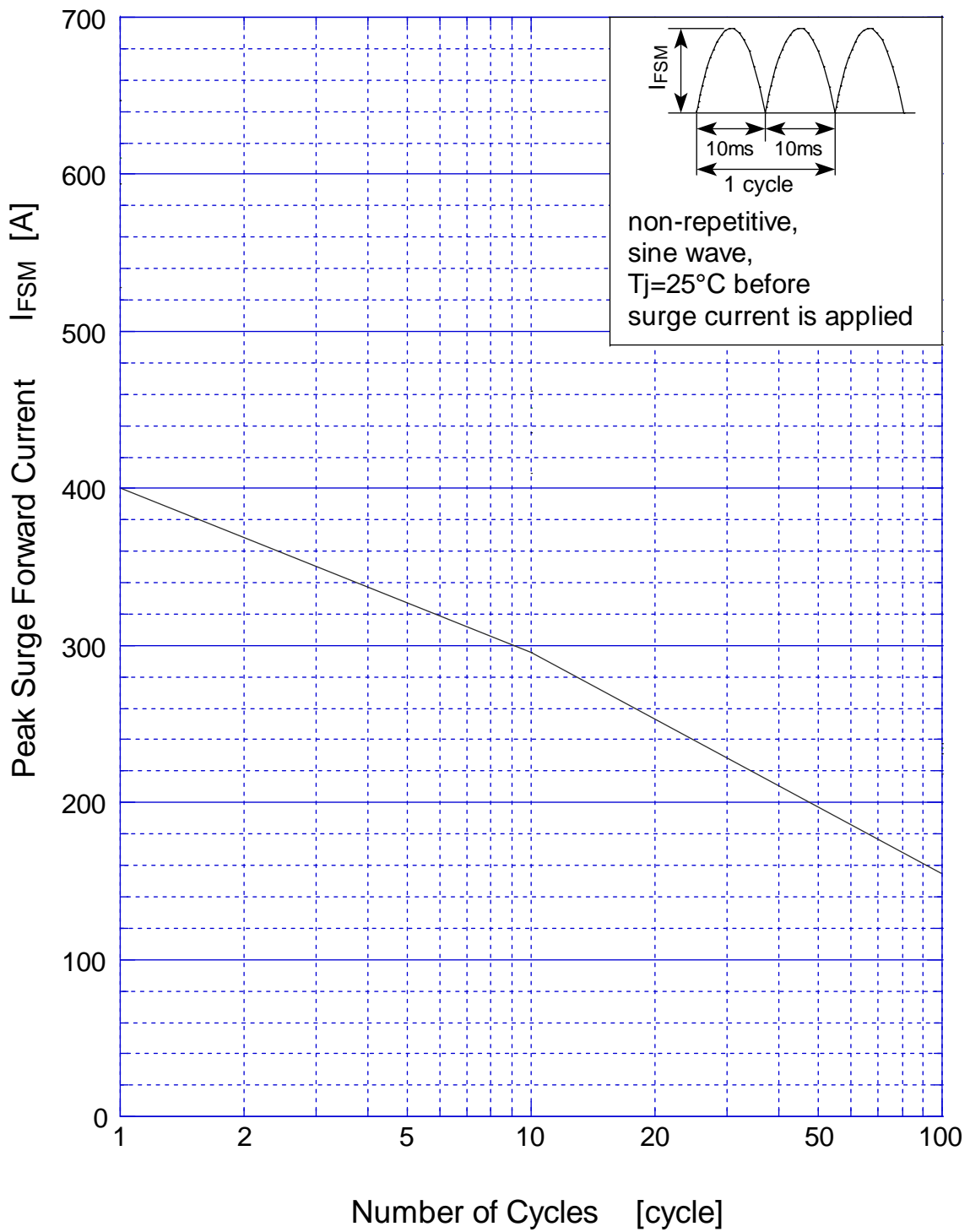

S40HC3 Junction Capacitance

