

# SHINDENGEN

## Super Fast Recovery Rectifiers

Single

# S3L60

## 600V 2.2A

### FEATURES

- High voltage super FRD
- Low noise
- trr50ns
- Applicable to Automatic Insertion

### APPLICATION

- PFC
- Switching power supply
- Free Wheel
- Home Appliances, Office Equipment

### OUTLINE DIMENSIONS

Case : AX14

(Unit : mm)

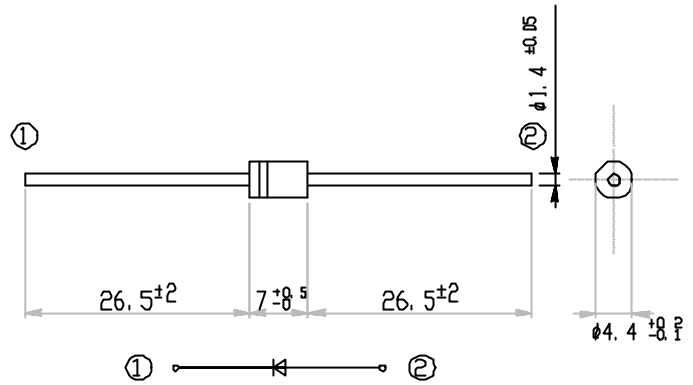

### RATINGS

Absolute Maximum Ratings (If not specified Tl=25 )

Item	Symbol	Conditions	Ratings	Unit
Storage Temperature	Tstg		-55 ~ 150	
Operating Junction Temperature	Tj		150	
Maximum Reverse Voltage	V <sub>RM</sub>		600	V
Average Rectified Forward Current	I <sub>O</sub>	50Hz sine wave, R-load, Ta=25	1.8	A
		50Hz sine wave, R-load, Tl=132	2.2	
Peak Surge Forward Current	I <sub>FSM</sub>	50Hz sine wave, Non-repetitive 1 cycle peak value, Tj=25	60	A

Electrical Characteristics (If not specified Tl=25 )

Item	Symbol	Conditions	Ratings	Unit
Forward Voltage	V <sub>F</sub>	I <sub>F</sub> =2.2A, Pulse measurement	Max.1.5	V
Reverse Current	I <sub>R</sub>	V <sub>R</sub> =V <sub>RM</sub> , Pulse measurement	Max.10	μA
Reverse Recovery Time	t <sub>rr</sub>	I <sub>F</sub> =0.5A, I <sub>R</sub> =1A	Max.50	ns
Thermal Resistance	j-l	junction to lead	Max.6.5	/W
	j-a	junction to ambient	Max.60	

# S3L60

## Forward Voltage

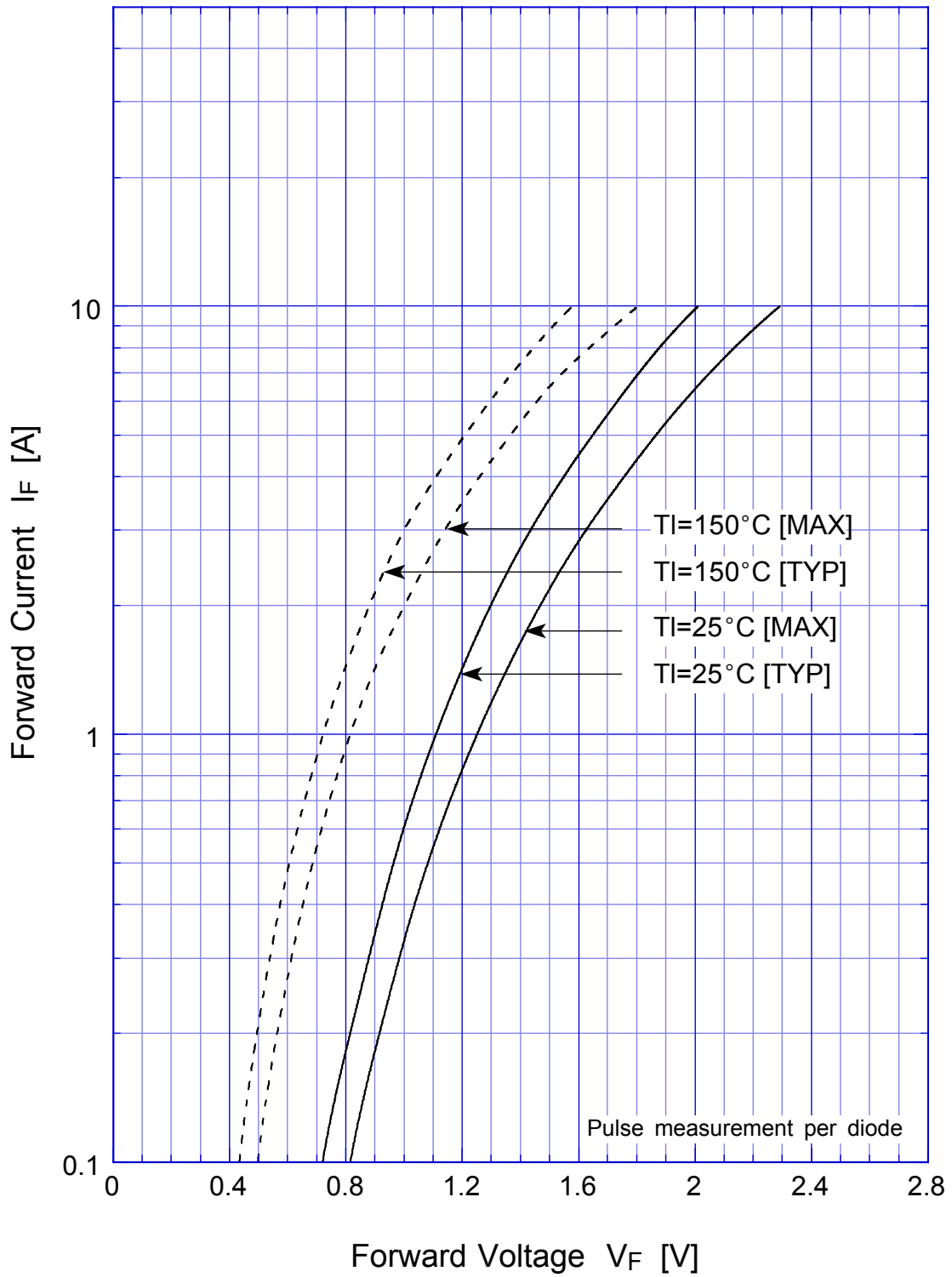

# S3L60

## Forward Power Dissipation

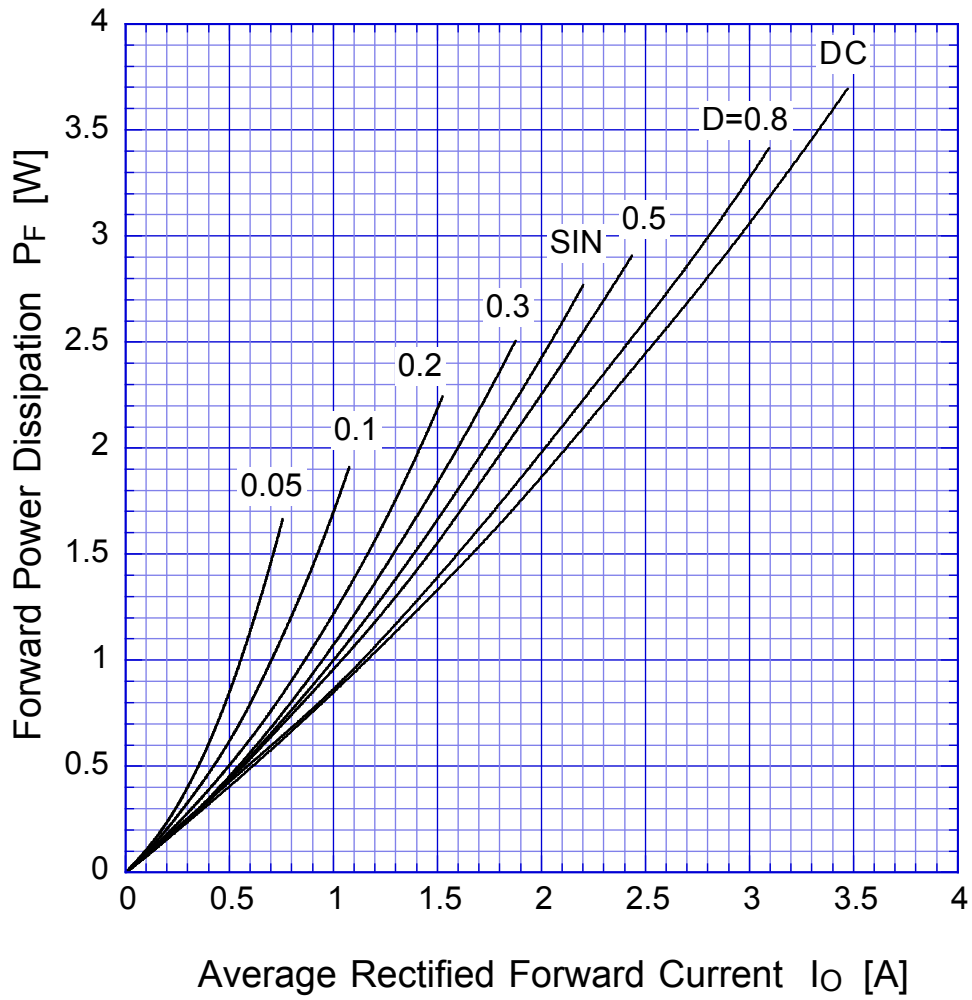

$T_j = T_{jmax}$

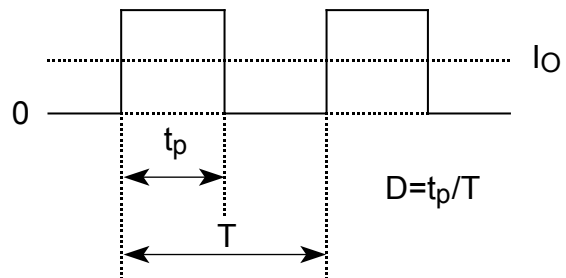

# S3L60

# Derating Curve

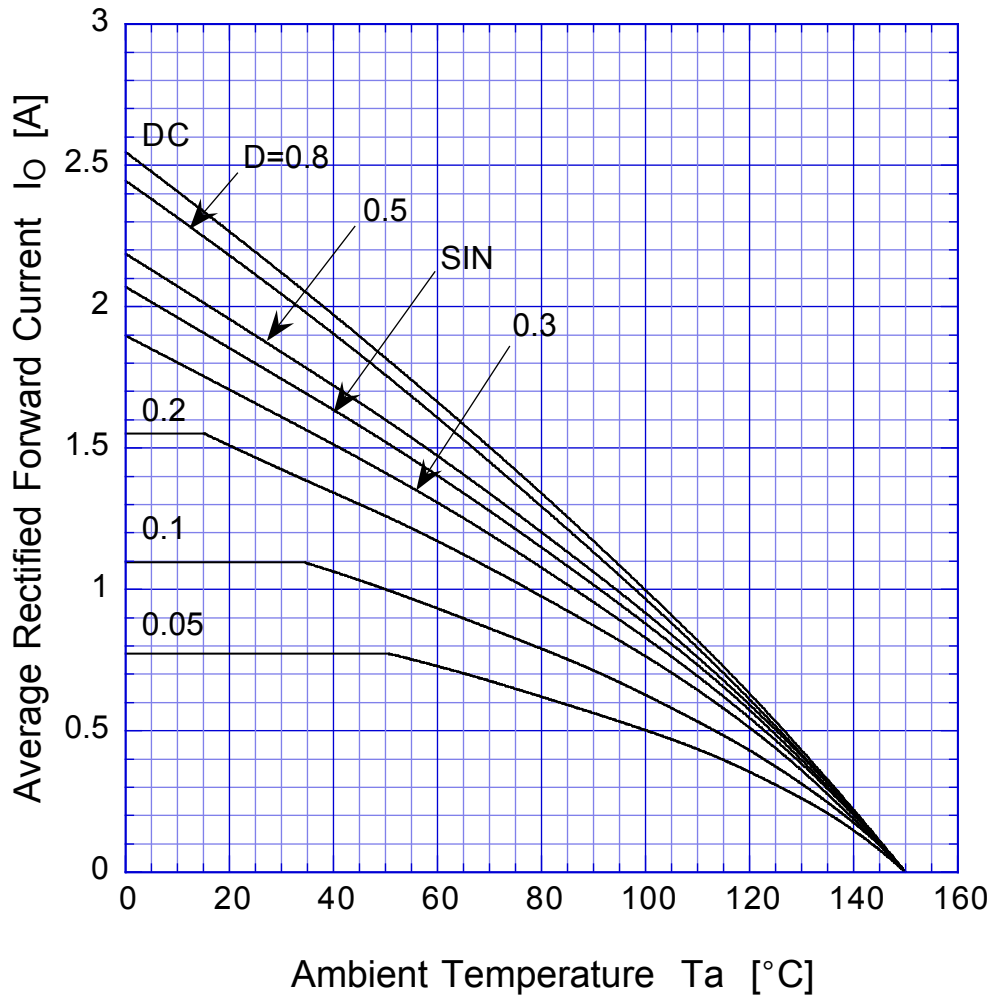

$$V_R = V_{RM}$$



# S3L60

# Derating Curve

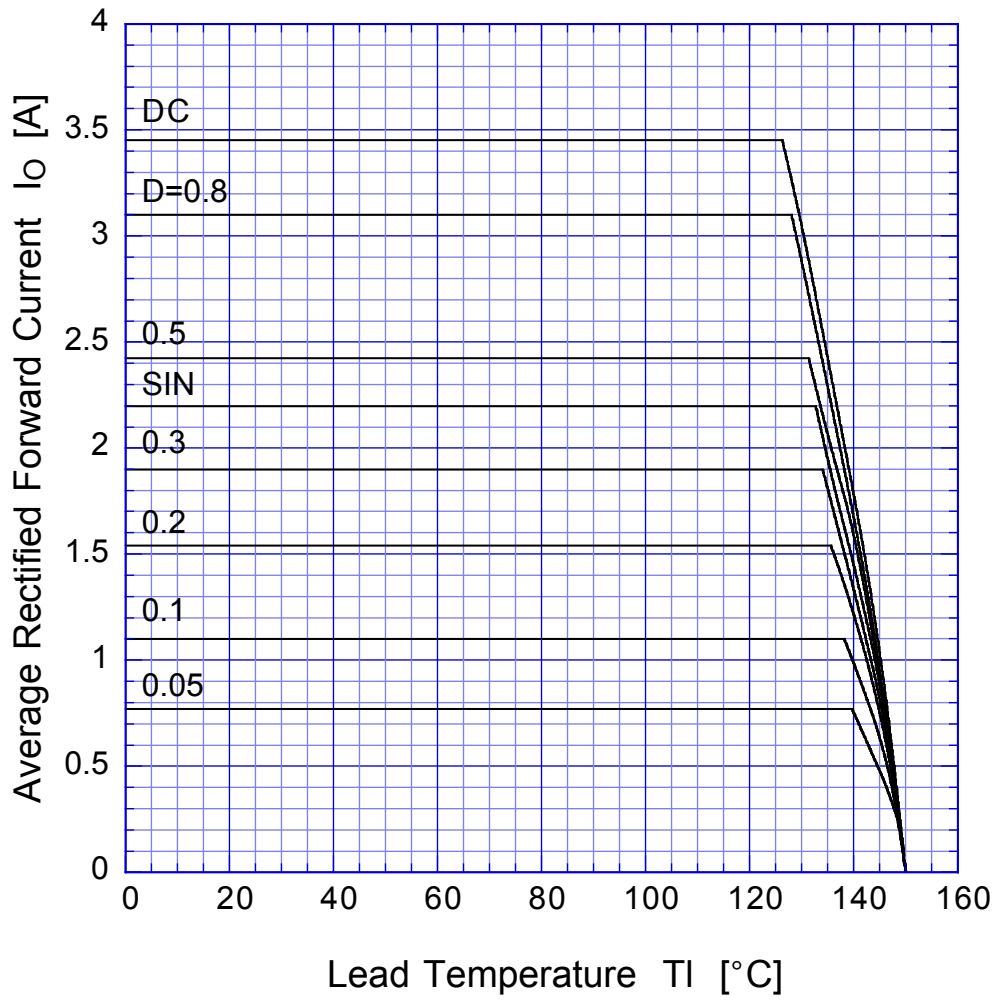

$$V_R = V_{RM}$$

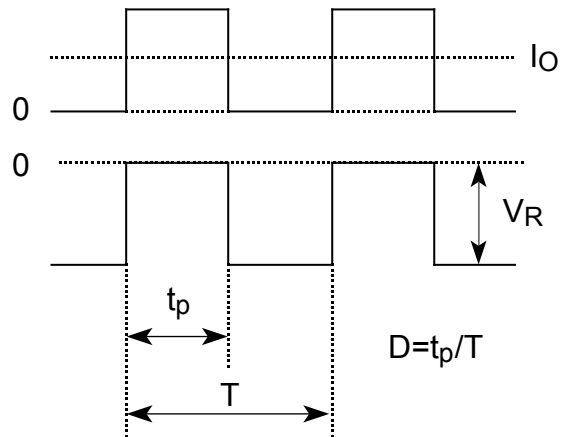

# S3L60

## Peak Surge Forward Capability

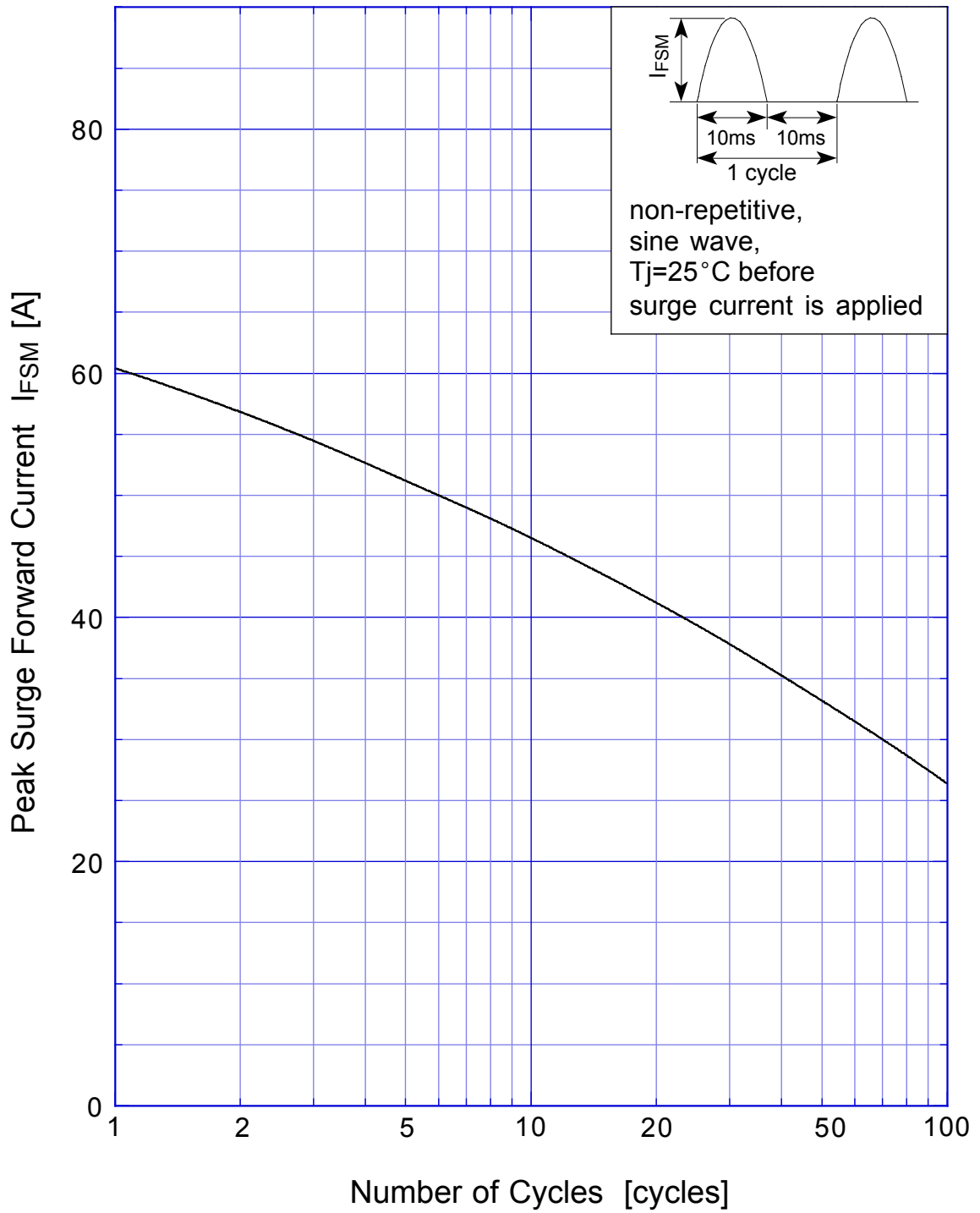

# S3L60

## Junction Capacitance

