

Man Portable Radar Warning Receiver

For Covert and U.A.V. Applications

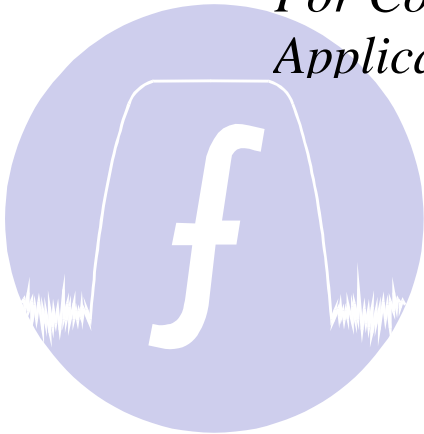

Figure 1 RWR Unit

Introduction

The unit is designed for Radar Warning Receiver (RWR) applications where small size and low power consumption are of prime importance, with filtering, amplification, detection and frequency measurement being combined into one multi-function unit.

Figure 2 shows a block diagram of the RWR and its three integral RF modules. Two amplitude measurement channels allow direction finding by amplitude comparison between adjacent antennas. One of these channels is also used in standby mode for detecting the presence of signals by polling round the antennas. A two-tier discriminator, fed from one of the amplitude channels via an SPDT switch, performs frequency measurement. Frequency resolution is nominally 160 MHz over an 8 to 18 GHz band.

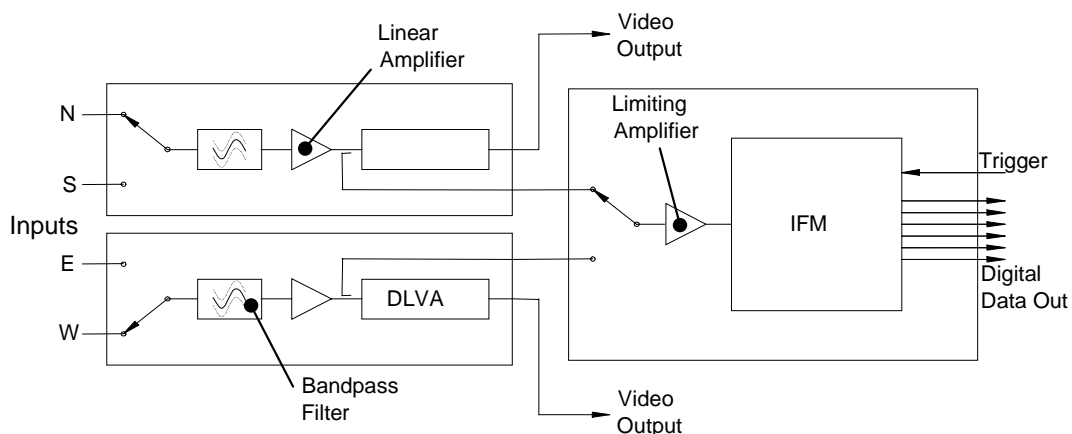

Figure 2: Radar Warning Receiver Block Diagram

Electrical Specifications

Operating temperature range 0°C to 70°C
 Characterised at 25°C.

Table 1: Electrical Specifications

Parameter	Amplitude Module	Frequency Module
Operating Frequency	8 to 18 GHz	8 to 18 GHz
Operating Dynamic Range	-73 to 0dBm	-43 to -5 dBm ¹
Frequency Measurement Resolution	-	150 MHz nom.
Frequency Measurement Accuracy	-	<200 MHz r.m.s.
Minimum Pulse Width	-	100 ns
Triggering	-	External Command
Trigger to Data Delay	-	<100 ns max.
Out of Band Rejection	d.c. to 7 GHz > 60 dB 20 to 26 GHz > 30 dB	-
Tangential Signal Sensitivity (8 dB Video SNR)	-73 dBm	-
Logging Range	-70 to -30 dBm	-
Frequency Flatness (Video)	±2.5 dB	-
Amplitude Tracking (Between any Two Modules at the Same Frequency and Temperature)	±1 dB Typical	-
Video Rise Time	30ns Typ 70 ns Max	-
Video Output Slope	50 mV/dB	-
Logging Linearity	±1 dB	-
Video Coupling	Active d.c. restored	-
Maximum Duty Cycle	50 %	-
RF Input Switch Isolation	>30 dB Typ	>30 dB Typ
RF Input Switch Speed	<5 µs	<5 µs
RF Input Switch Control	TTL	TTL
Insertion Gain RF Input to RF Output	27dB nominal	-
Insertion Ripple	±2dB	
Input Return Loss	7dB min (10dB typ)	
Power Supply Current (operating - no rf)	+6 V at 130 mA -6 V at 50 mA	+6 V at 200 mA -6 V at 30 mA
Power Supply Current (standby)	+6 V at 50 mA -6 V at 50 mA	+6 V at 120 mA -6 V at 30 mA
Power-up Time (standby to on)	<100 µs	<100 µs
Power-up Time (cold start)	<30ms	<2ms
Dimensions	4 x 1 x 0.25 inches 101.6 x 25.4 x 6.35 mm	4 x 2 x 0.25 inches 101.6 x 50.8 x 6.35 mm
Weight ²	50 grams	85 grams
Microwave Input Connector	SSMA Female	Dynawave

¹ not including amplitude module gain
² plus 10 grams for the interconnect module

System Timing

The operation of the frequency measurement unit is as follows:

When r.f. enters the discriminator circuits, the video voltages settle after a delay depending on the video bandwidth. The video signals are then stable and can be digitised by the comparators and ASIC. This digitization takes a maximum of 15 ns (ASIC worst case timing). Therefore valid raw frequency data is available 75 ns after the leading edge of the r.f. pulse. The raw frequency data is decoded in the EPROM look-up table which takes 55 ns.

Figure 3: System Timing Diagram

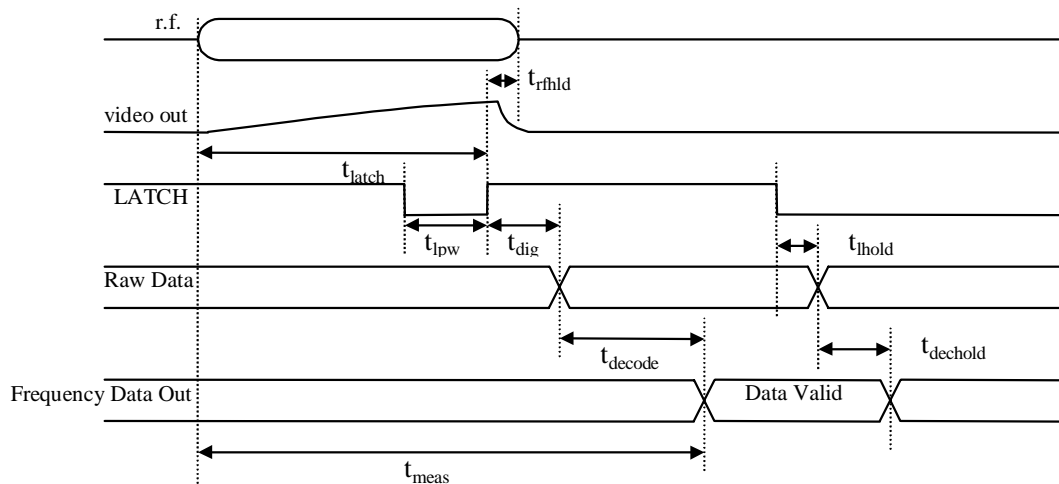

Table 2: Timing

Description	symbol	min	max	units
time between latch edge and trailing edge of r.f	t_{rfhld}	6		ns
time from leading edge of r.f. and latch edge	t_{latch}	60		ns
Width of latch pulse	t_{lpw}	5		ns
time to digitise video	t_{dig}		15	ns
time from latch disable and raw data invalid	t_{hold}		10	ns
time to decode raw frequency data	t_{decode}		55	ns
time to hold decoded frequency data	$t_{dechold}$		7	ns
time from start of r.f. to valid frequency out	t_{meas}	130		ns

The LATCH signal holds the digitised frequency data when it is in the logic high state. When the LATCH signal is low, the digitising circuits are transparent and the data buses may change state rapidly increasing current consumption, thus to reduce this effect the latch signal should be held high and digitising initiated by a narrow logic low pulse. In order to capture 100 ns pulses the rising edge of the LATCH signal must occur no later than 94 ns after the start of the r.f. pulse.

Application Information

The Amplitude Measurement Module and the Frequency Measurement Module are designed to be used together as the front end for a Radar Warning Receiver. The configuration described here has two Amplitude Modules facilitating direction of approach measurement from 4 directional antennae. If desired, only one Amplitude Module can be used in conjunction with an omni directional antenna forming a simple Radar Warning Receiver for simple classification of the threat signal. The unused input ports must be terminated with 50Ω loads.

Both modules feature a power saving standby mode that turns off the bias to the microwave amplifiers. The power supply can be removed completely for better power efficiency but there is a penalty to pay in start-up time as the modules incorporate switch mode DC-DC converters that take time to stabilise. The amplitude module also incorporates a CW removal circuit which can take up to 30ms to stabilise.

The frequency measurement module requires an externally generated latch signal to hold the frequency data word on the digital output. This can be derived from the amplitude measurement video output or from some other source. The responsibility for generating the latch rests with the application circuit. Refer to figure 3 for timing information for the latch generation.

Options and Future Developments

Other configurations may be possible, e.g., SMA connectors instead of SSMA, custom outline, different logging range, etc. In addition Filtronic is developing this product further to provide extended frequency range and a back end control system to integrate the trigger, direction of approach and emitter characterisation functions. Please contact the factory for further details.

While every effort is made to ensure the accuracy this release, please check with the factory for the latest information.

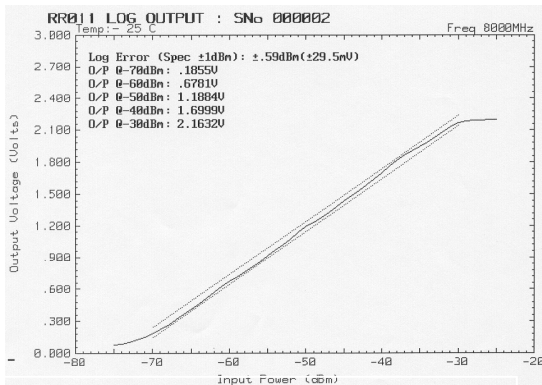
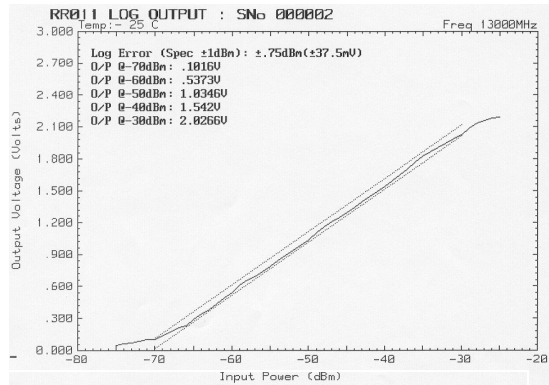
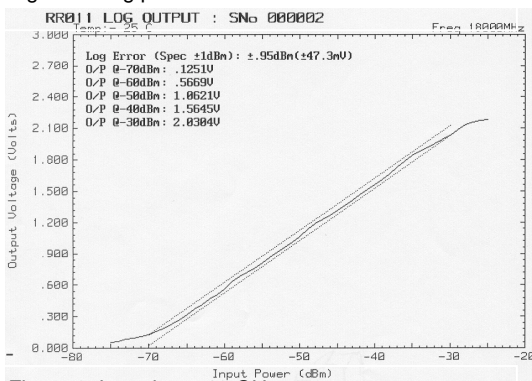
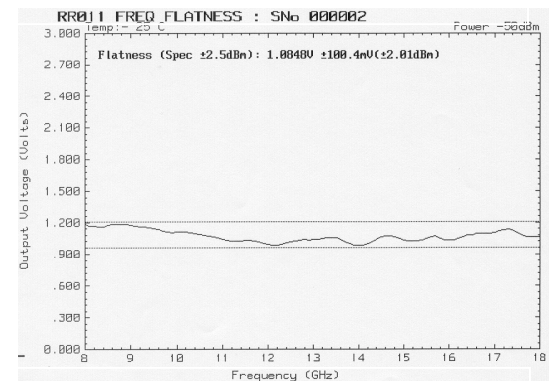
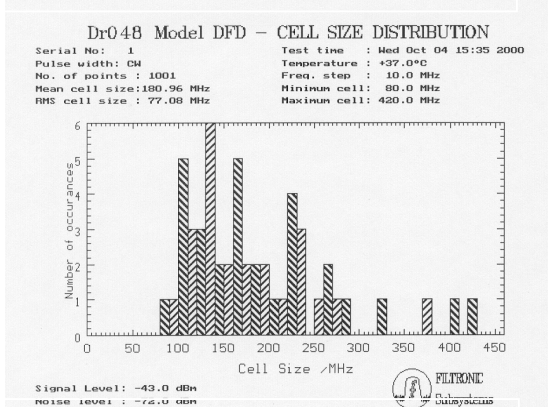
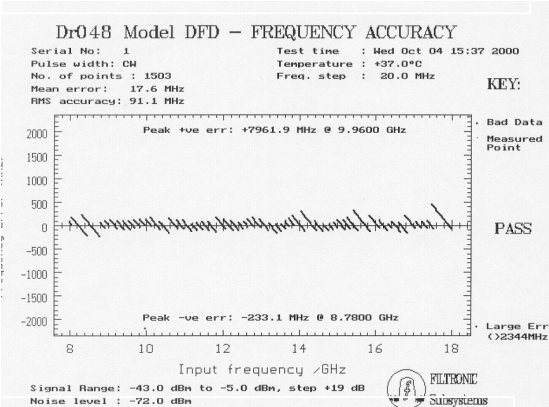
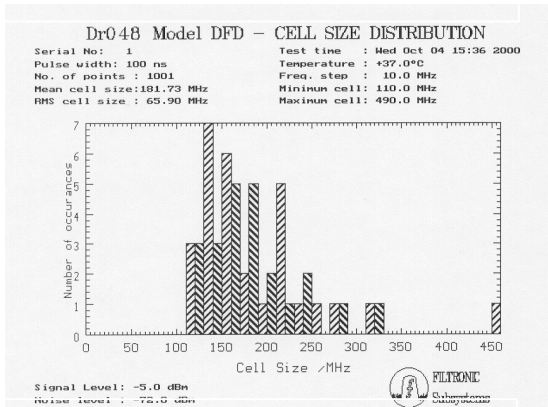
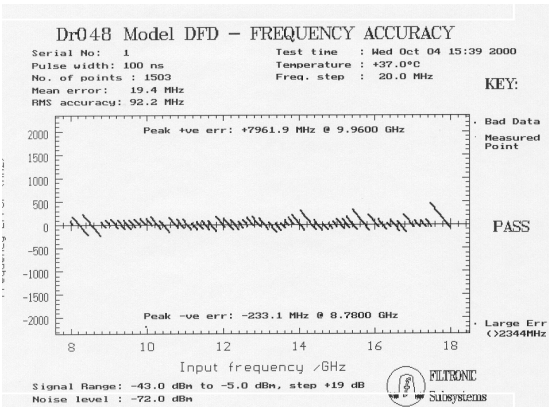
Typical Performance Data

Figure 4: Log plot at 8 GHz

Figure 5: Log plot at 13 GHz

Figure 6: Log plot at 18 GHz

Figure 7: Frequency Flatness at -50dBm input

Figure 8: Cell size distribution - CW

Figure 9: Frequency accuracy - CW

Figure 10: Cell size distribution - 100ns pulse

Figure 11: Frequency accuracy - 100ns pulse

Connector Details

The Frequency Measurement Module connector is a 15 way Nanonics® Dualobe® single row receptacle. The mating part is a 15 way single row plug with wire leads. Example part number: SSM015PC2DC012N

Table 4: Frequency Measurement Module Connector Designations

Pin	Type	Signal
1	POWER	+6V
2	POWER	+6V
3	POWER	-6V
4	POWER	DGND
5	IN TTL	Input Select
6	OUT TTL	D0
7	OUT TTL	D1
8	OUT TTL	D2
9	OUT TTL	D3
10	OUT TTL	D4
11	OUT TTL	D5
12	IN TTL	Trigger
13	IN TTL	Standby (active low)
14	POWER	GND
15	POWER	GND

The Amplitude Measurement Module connector is a 9 way Nanonics® Dualobe® single row receptacle. The mating part is a 9 way single row plug with wire leads. Example part number: SSM009PC2DC012N

Table 5: Amplitude Measurement Module Connector Designations

Pin	Type	Signal
1	POWER	+6V
2	POWER	+6V
3	POWER	-6V
4	GND	Power Ground
5	IN TTL	Antenna Select
6	IN TTL	Standby (active low)
7	GND	Digital Ground
8	OUTPUT	Video Output
9	GND	Video Ground

The mating connectors are available from:

Nanonics® Corporation

Call (623) 581-6188 or Fax (623) 581-8242

21644 North 14th Ave., Phoenix, Arizona 85027-2840

email: info@nanonics.com

www.nanonics.com

