

Actuator-type photointerrupter

RPI-5100

The RPI-5100 is a compact, actuator-type photointerrupter.

●Applications

Optical control equipment
Facsimiles
Plain paper copiers

●Features

- 1) Compact.
- 2) Minimal influence from stray light.
- 3) Equipped with an actuator mount.

●External dimensions (Units: mm)

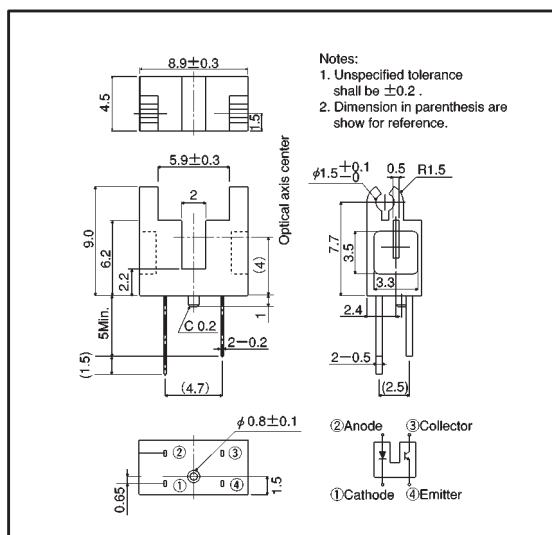

●Absolute maximum ratings (Ta = 25°C)

Parameter		Symbol	Limits	Unit
Input(LED)	Forward current	I _F	50	mA
	Reverse voltage	V _R	5	V
	Power dissipation	P _D	80	mW
Output (photo-transistor)	Collector-emitter voltage	V _{CEO}	30	V
	Emitter-collector voltage	V _{ECO}	4.5	V
	Collector current	I _C	30	mA
	Collector power dissipation	P _C	80	mW
Operating temperature		T _{opr}	-25~+85	°C
Storage temperature		T _{stg}	-30~+85	°C

●Electrical and optical characteristics (Ta = 25°C)

Parameter		Symbol	Min.	Typ.	Max.	Unit	Conditions
Input characteristics	Forward voltage	V_F	—	1.3	1.6	V	$I_F=50\text{mA}$
	Reverse current	I_R	—	—	10	μA	$V_R=5\text{V}$
Output characteristics	Dark current	I_{CEO}	—	—	0.5	μA	$V_{CE}=10\text{V}$
	Peak sensitivity wavelength	λ_P	—	800	—	nm	—
Transfer characteristics	Collector current	I_C	0.2	1.0	—	mA	$V_{CE}=5\text{V}, I_F=20\text{mA}$
	Collector-emitter saturation voltage	$V_{CE(sat)}$	—	—	0.4	V	$I_F=20\text{mA}, I_C=0.1\text{mA}$
	Response time	$t_r \cdot t_f$	—	10	—	μs	$V_{CC}=5\text{V}, I_F=20\text{mA}, R_L=100\Omega$

●Electrical and optical characteristic curves

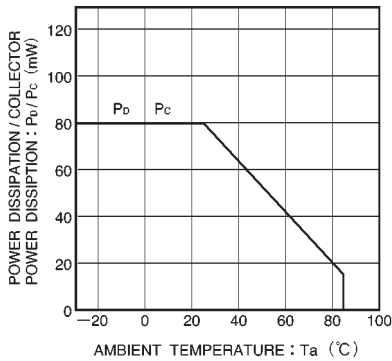

Fig.1 Power dissipation / collector power dissipation vs. ambient temperature

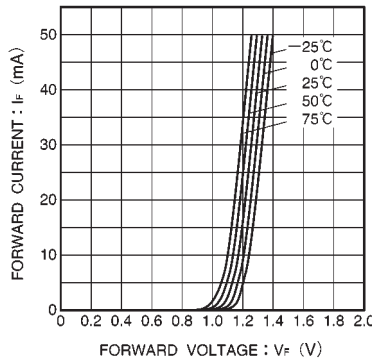

Fig.2 Forward current vs. forward voltage

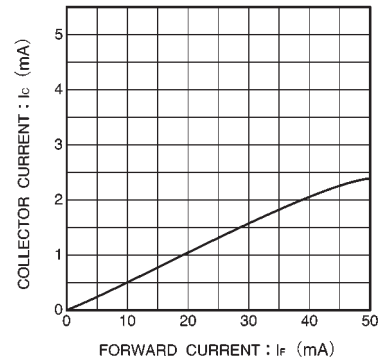

Fig.3 Collector current vs. forward current

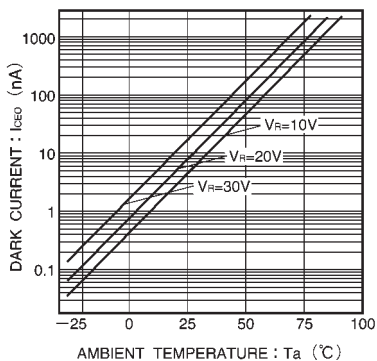

Fig.4 Dark current vs. ambient temperature

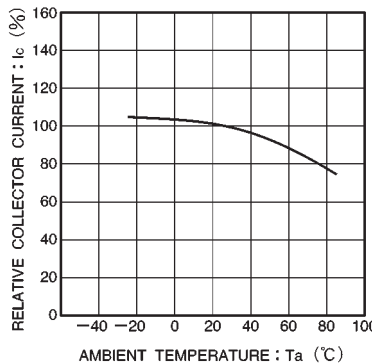

Fig.5 Relative output vs. ambient temperature

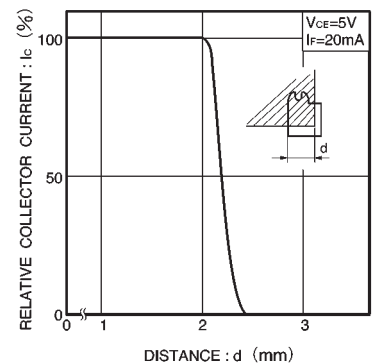

Fig.6 Relative output vs. distance (I)

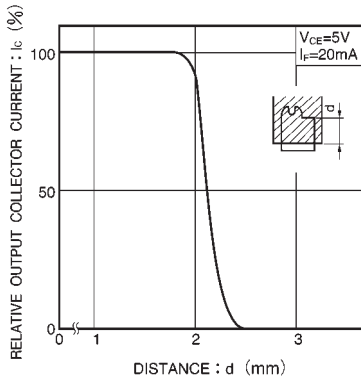

Fig.7 Relative output vs. distance (II)

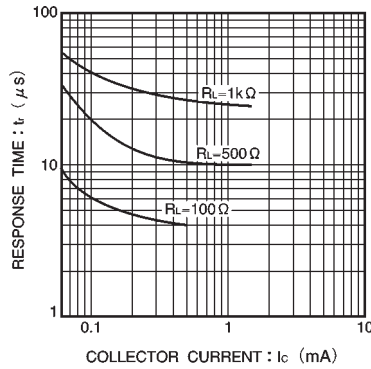

Fig.8 Response time vs. output current

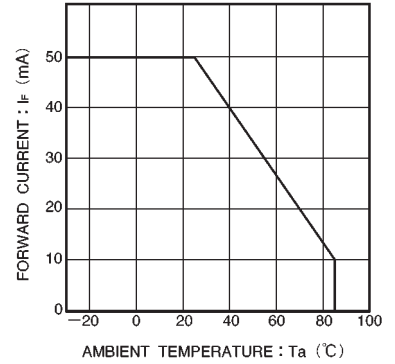

Fig.9 Forward current falloff

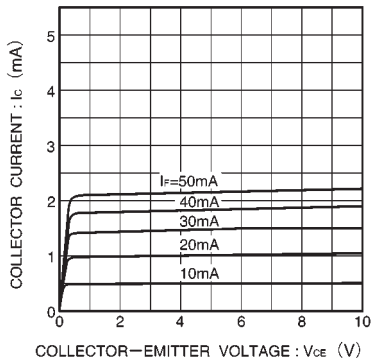
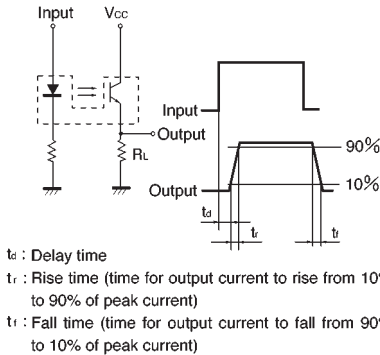

Fig.10 Output characteristics



t_d : Delay time
 t_r : Rise time (time for output current to rise from 10% to 90% of peak current)
 t_f : Fall time (time for output current to fall from 90% to 10% of peak current)

Fig.11 Response time measurement circuit