



- **Ideal for European 857.65 MHz Transmitters**
- **Very Low Series Resistance**
- **Quartz Stability**
- **Surface-Mount Ceramic Case with 21 mm² Footprint**
- **Complies with Directive 2002/95/EC (RoHS)**



The RO2166D is a true one-port, surface-acoustic-wave (SAW) resonator in a surface-mount ceramic case. It provides reliable, fundamental-mode, quartz frequency stabilization of local oscillators operating at 857.65 MHz. This SAW is designed for 857.65 MHz superhet receivers with 10.7 MHz IF. Applications include remote-control and wireless security receivers operating under ETSI-ETS 300 220 in Europe and under FTZ 17 TR 2100 in Germany.

Absolute Maximum Ratings

Rating	Value	Units
CW RF Power Dissipation	+0	dBm
DC Voltage Between Terminals	±12	VDC
Case Temperature	-40 to +85	°C
Soldering Temperature (10 seconds / 5 cycles max.)	260	°C

RO2166D
RO2166D-1
RO2166D-2

857.65 MHz
SAW
Resonator

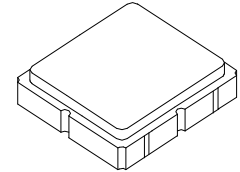

SM3838-6 Case
3.8 X 3.8

Electrical Characteristics

Characteristic			Sym	Notes	Minimum	Typical	Maximum	Units
Frequency (+25 °C)	Nominal Frequency	RO2166D	f _C	2, 3, 4, 5	857.575		857.725	MHz
		RO2166D-1			857.500		857.800	
		RO2166D-2			857.550		857.750	
	Tolerance from 857.65 MHz	RO2166D	Δf _C				±75	kHz
		RO2166D-1					±150	
		RO2166D-2					±100	
Insertion Loss		IL	2, 5, 6		1.1	2.0	dB	
Quality Factor	Unloaded Q	Q _U	5, 6, 7		1086			
	50 Ω Loaded Q	Q _L			8474			
Temperature Stability	Turnover Temperature	T _O	6, 7, 8		15	30	45	°C
	Turnover Frequency	f _O				f _C		kHz
	Frequency Temperature Coefficient	FTC				0.032		
Frequency Aging	Absolute Value during the First Year	fA	1			10		ppm/yr
DC Insulation Resistance between Any Two Terminals				5	1.0			MΩ
RF Equivalent RLC Model	Motional Resistance	R _M	5, 6, 7, 9			14.6		Ω
	Motional Inductance	L _M				23		μH
	Motional Capacitance	C _M				1.5		fF
	Transducer Static Capacitance	C _O		5, 6, 9	2.1	2.3	3.0	pF
Test Fixture Shunt Inductance			L _{TEST}	2, 7		15.3		nH
Lid Symbolization (in addition to Lot and/or Date Codes)			483 / YWWS					
Standard Reel Quantity	Reel Size 7 Inch		500 Pieces / Reel					
	Reel Size 13 Inch		3000 Pieces / Reel					



CAUTION: Electrostatic Sensitive Device. Observe precautions for handling.

Notes:

1. Frequency aging is the change in f_C with time and is specified at +65°C or less. Aging may exceed the specification for prolonged temperatures above +65°C. Typically, aging is greatest the first year after manufacture, decreasing in subsequent years.
2. The center frequency, f_C, is measured at the minimum insertion loss point, IL_{MIN}, with the resonator in the 50 Ω test system (VSWR ≤ 1.2:1). The shunt inductance, L_{TEST}, is tuned for parallel resonance with C_O at f_C. Typically, f_OOSCILLATOR or f_OTRANSMITTER is approximately equal to the resonator f_C.
3. One or more of the following United States patents apply: 4,454,488 and 4,616,197.
4. Typically, equipment utilizing this device requires emissions testing and government approval, which is the responsibility of the equipment manufacturer.
5. Unless noted otherwise, case temperature T_C = +25°C±2°C.
6. The design, manufacturing process, and specifications of this device are subject to change without notice.
7. Derived mathematically from one or more of the following directly measured parameters: f_C, IL, 3 dB bandwidth, f_C versus T_C, and C_O.
8. Turnover temperature, T_O, is the temperature of maximum (or turnover) frequency, f_O. The nominal frequency at any case temperature, T_C, may be calculated from: $f = f_O [1 - FTC (T_O - T_C)^2]$. Typically oscillator T_O is approximately equal to the specified resonator T_O.
9. This equivalent RLC model approximates resonator performance near the resonant frequency and is provided for reference only. The capacitance C_O is the static (nonmotional) capacitance between the two terminals measured at low frequency (10 MHz) with a capacitance meter. The measurement includes parasitic capacitance with "NC" pads unconnected. Case parasitic capacitance is approximately 0.05 pF. Transducer parallel capacitance can be calculated as: $C_P \approx C_O - 0.05 \text{ pF}$.

Electrical Connections

The SAW resonator is bidirectional and may be installed with either orientation. The two terminals are interchangeable and unnumbered. The callout NC indicates no internal connection. The NC pads assist with mechanical positioning and stability. External grounding of the NC pads is recommended to help reduce parasitic capacitance in the circuit.

Pin	Connection
1	NC
2	Terminal
3	NC
4	NC
5	Terminal
6	NC

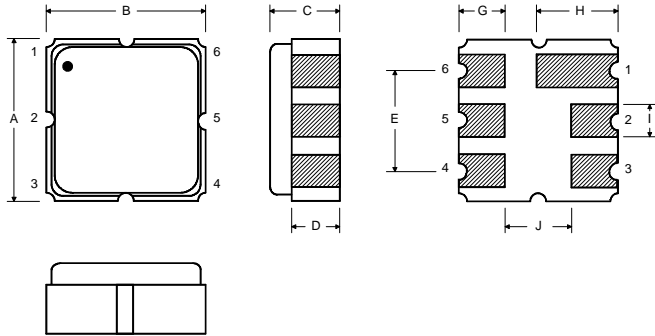

Case Dimensions

Dimension	mm			Inches		
	Min	Nom	Max	Min	Nom	Max
A	3.60	3.80	4.0	0.14	0.15	0.16
B	3.60	3.80	4.0	0.14	0.15	0.16
C	1.00	1.20	1.40	0.04	0.05	0.055
D	0.95	1.10	1.25	0.037	0.043	0.05
E	2.39	2.54	2.69	0.090	0.10	0.110
G	0.90	1.0	1.10	0.035	0.04	0.043
H	1.90	2.0	2.10	0.75	0.08	0.83
I	0.50	0.6	0.70	0.020	0.024	0.028
J	1.70	1.8	1.90	0.067	0.07	0.075

Typical Test Circuit

The test circuit inductor, L_{TEST} , is tuned to resonate with the static capacitance, C_O , at F_C .

Electrical Test

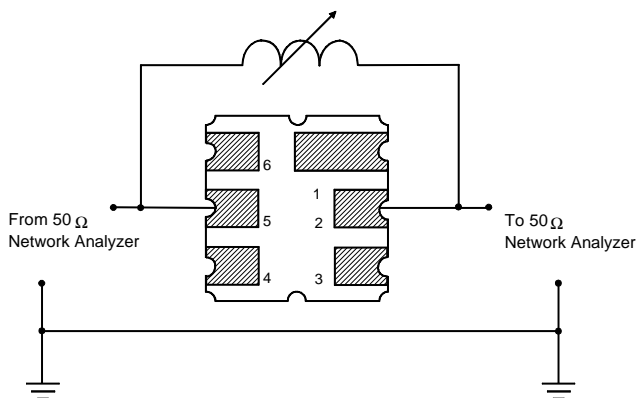

Power Test

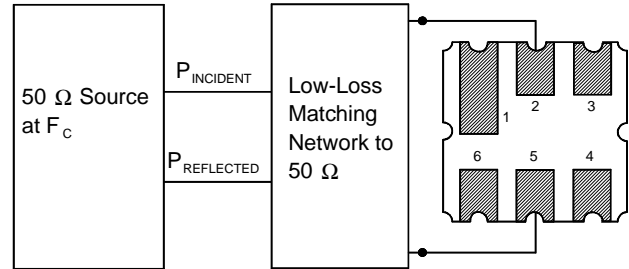

Typical Application Circuits

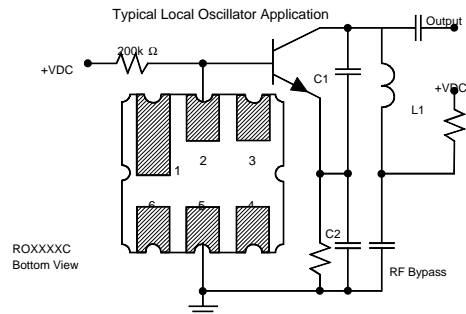
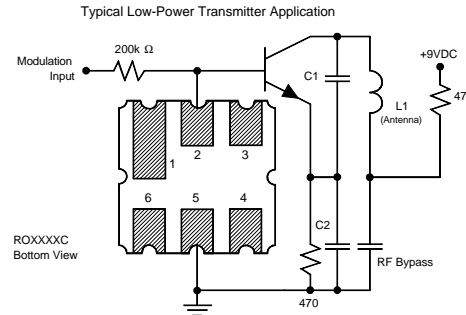

Equivalent LC Model

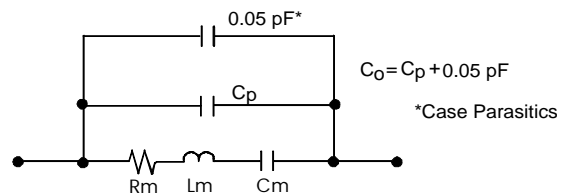

Temperature Characteristics

The curve shown on the right accounts for resonator contribution only and does not include LC component temperature contributions.

