

RMPA27000

27–29 GHz 1.8 Watt Power Amplifier MMIC

General Description

The Fairchild Semiconductor's RMPA27000 is a high efficiency power amplifier designed for use in point to point and point to multi-point radios, and various communications applications. The RMPA27000 is a 3-stage GaAs MMIC amplifier utilizing our advanced 0.15 μ m gate length Power PHEMT process and can be used in conjunction with other driver or power amplifiers to achieve the required total power output.

Features

- 18dB small signal gain (typ.)
- 32.5dBm saturated power out (typ.)
- DC Bias connections on top or bottom side
- Circuit contains individual source vias
- Chip size 4.00mm x 2.98mm

Device

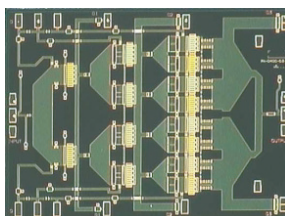

Absolute Ratings

Symbol	Parameter	Ratings	Units
V _d	Positive DC Voltage (+5V Typical)	+6	V
V _g	Negative DC Voltage	-2	V
V _{dg}	Simultaneous (V _d -V _g)	+8	V
I _D	Positive DC Current	2450	mA
P _{IN}	RF Input Power (from 50 Ω source)	+22	dBm
T _C	Operating Baseplate Temperature	-30 to +85	°C
T _{STG}	Storage Temperature Range	-55 to +125	°C
R _{JC}	Thermal Resistance (Channel to Backside)	5.6	°C/W

Electrical Characteristics (At 25°C), 50Ω system, Vd = +5V, Quiescent current (Idq) = 1500mA

Parameter	Min	Typ	Max	Units
Frequency Range	27		29	GHz
Gate Supply Voltage (Vg) ¹		-0.2		V
Gain Small Signal (Pin = 0dBm)	16	18		dB
Gain Variation vs. Frequency		±0.5		dB
Power Output at 1dBm Compression		32.5		dBm
Power Output Saturated: (Pin = +19dBm)	32	32.5		dBm
Drain Current at Pin = 0dBm		1500		mA
Drain Current at P1dB Compression		1780		mA
Power Added Efficiency (PAE): at P1dB		20		%
OIP3 (16dBm/Tone)		38		dBm
Input Return Loss (Pin = 0dBm)		6		dB
Output Return Loss (Pin = 0dBm)		10		dB

Note:

1. Typical range of negative gate voltages is -1.0 to 0.0V to set typical Idq of 1500 mA.

Application Information

CAUTION: THIS IS AN ESD SENSITIVE DEVICE.

Chip carrier material should be selected to have GaAs compatible thermal coefficient of expansion and high thermal conductivity such as copper molybdenum or copper tungsten. The chip carrier should be machined, finished flat, plated with gold over nickel and should be capable of withstanding 325°C for 15 minutes.

Die attachment should utilize Gold/Tin (80/20) eutectic alloy solder and should avoid hydrogen environment for PHEMT devices. Note that the backside of the chip is gold plated and is used as RF and DC ground.

These GaAs devices should be handled with care and stored in dry nitrogen environment to prevent contamination of bonding surfaces. These are ESD sensitive devices and should be handled with appropriate precaution including the use of wrist grounding straps. All die attach and wire/ribbon bond equipment must be well grounded to prevent static discharges through the device.

Recommended wire bonding uses 3mils wide and 0.5mil thick gold ribbon with lengths as short as practical allowing for appropriate stress relief. The RF input and output bonds should be typically 0.012" long corresponding to a typical 2mil gap between the chip and the substrate material.

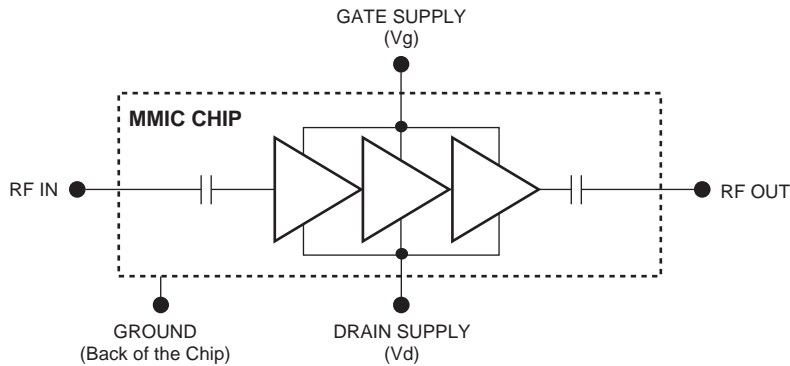

Figure 1. Functional Block Diagram

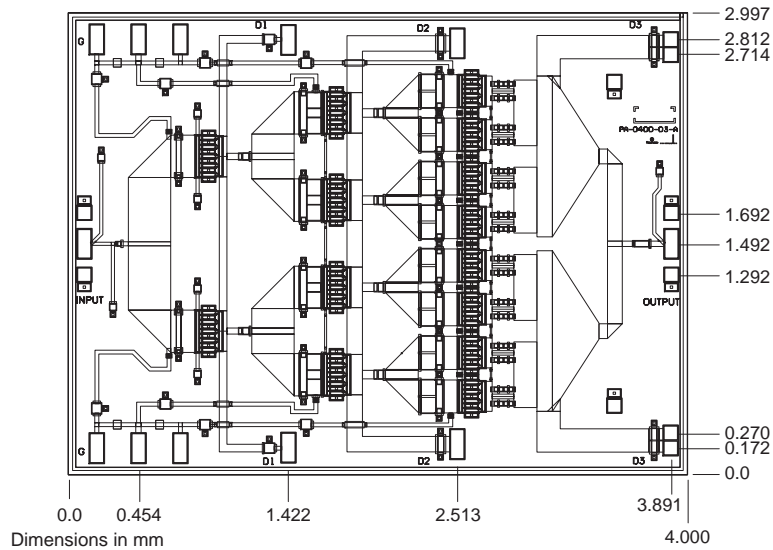

Figure 2. Chip Layout and Bond Pad Locations
(Chip Size is 4.000mm x 2.997mm x 50µm Typical. Back of chip is RF and DC Ground)

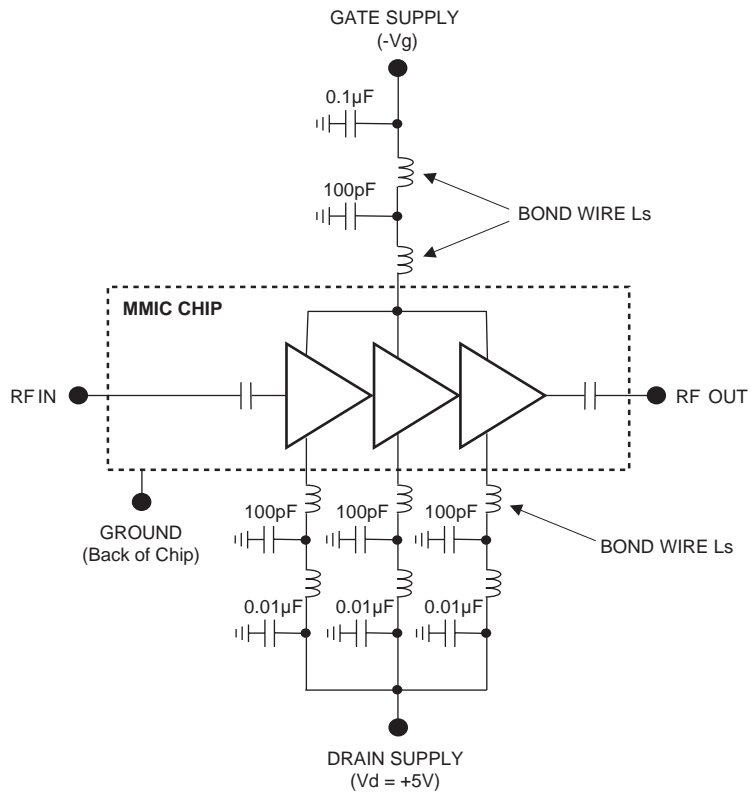
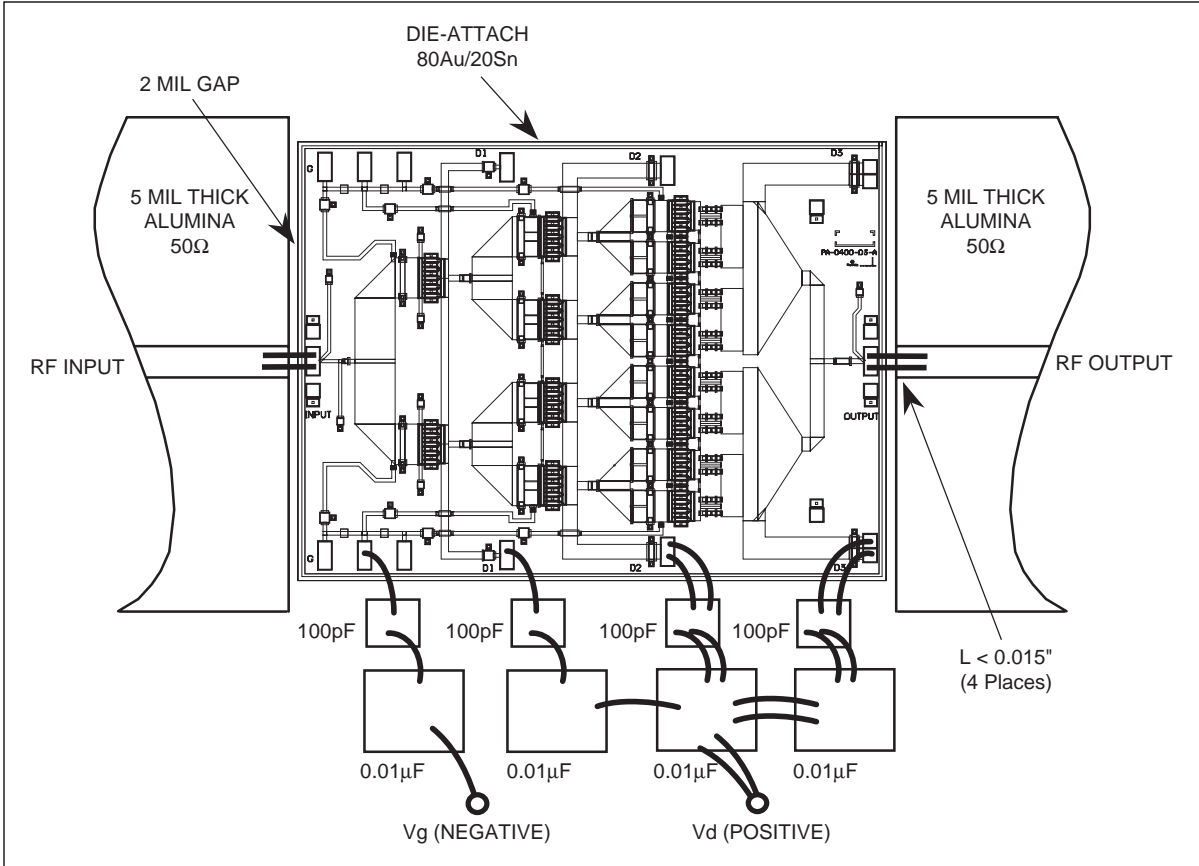

Figure 3. Chip Layout on Bond Pad Locations



MMIC has Vg and Vd bias pads accessible on both top and bottom sides. DC bias connections are required only on one side.

Note:
Use 0.003" by 0.0005" Gold Ribbon or 1 mil gold wire for bonding. RF input and output bonds should be less than 0.015" long with stress relief.

Figure 4. Recommended Assembly and Bonding Diagram

Recommended Procedure for Biasing and Operation

CAUTION: LOSS OF GATE VOLTAGE (V_g) WHILE DRAIN VOLTAGE (V_d) IS PRESENT MAY DAMAGE THE AMPLIFIER CHIP.

The following sequence of steps must be followed to properly test the amplifier.

Step 1: Turn off RF input power.

Step 2: Connect the DC supply grounds to the grounds of the chip carrier. Slowly apply negative gate bias supply voltage of $-1.5V$ to V_g .

Step 3: Slowly apply positive drain bias supply voltage of $+5V$ to V_d .

Step 4: Adjust gate bias voltage to set the quiescent current of $I_{dq} = 1500mA$.

Step 5: After the bias condition is established, the RF input signal may now be applied at the appropriate frequency band.

Step 6: Follow turn-off sequence of:

- (i) Turn off RF input power,
- (ii) Turn down and off drain voltage (V_d),
- (iii) Turn down and off gate bias voltage (V_g).

Typical Characteristics

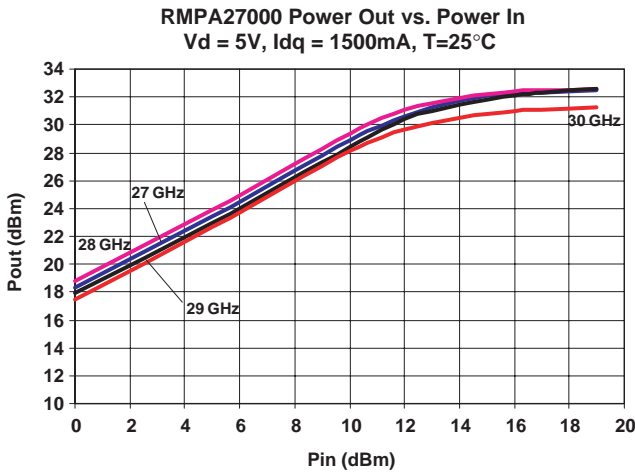
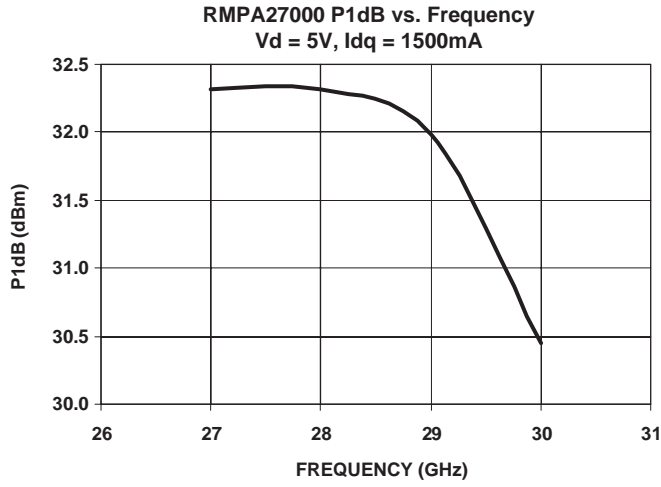
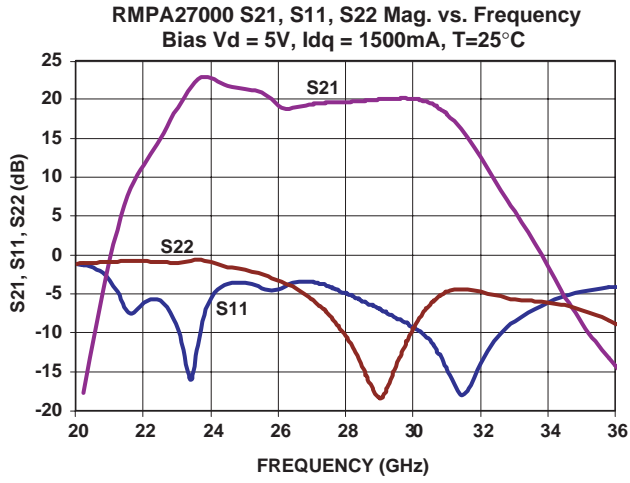

Typical Characteristics (Continued)

RMPA27000 Gain vs. Power In
 $V_d = 5V, I_{dq} = 1500mA, T = 25^\circ C$

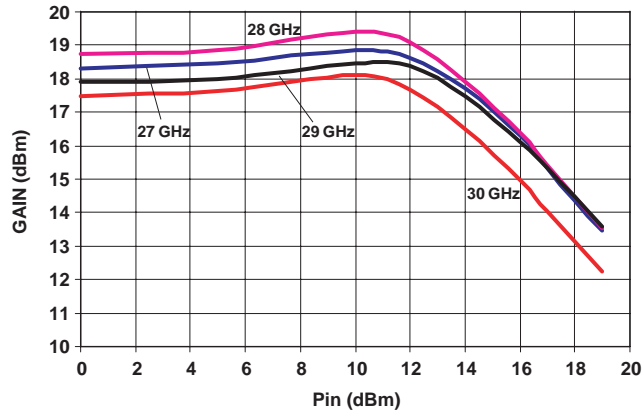

RMPA27000 Two-Tone OIP3 vs. Output Power/tone
 $V_d = 5V, I_{dq} = 1500mA, T = 25^\circ C$

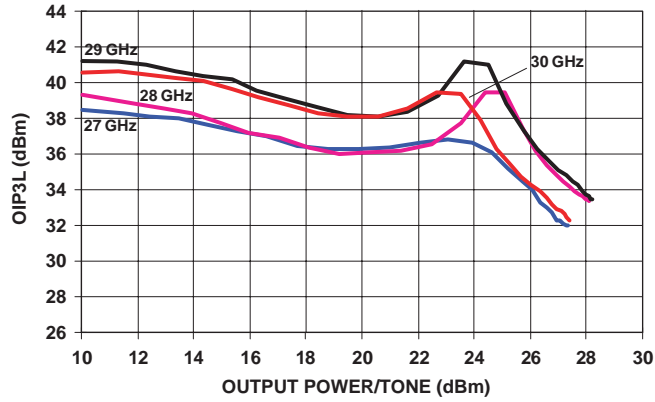

TRADEMARKS

The following are registered and unregistered trademarks Fairchild Semiconductor owns or is authorized to use and is not intended to be an exhaustive list of all such trademarks.

ACEx™	FAST®	ISOPLANAR™	Power247™	SuperFET™
ActiveArray™	FASTr™	LittleFET™	PowerSaver™	SuperSOT™-3
Bottomless™	FPST™	MICROCOUPLER™	PowerTrench®	SuperSOT™-6
CoolFET™	FRFET™	MicroFET™	QFET®	SuperSOT™-8
CROSSVOLT™	GlobalOptoisolator™	MicroPak™	QS™	SyncFET™
DOMET™	GTO™	MICROWIRE™	QT Optoelectronics™	TinyLogic®
EcoSPARK™	HiSeC™	MSX™	Quiet Series™	TINYOPTO™
E ² C MOS™	ꝑC™	MSXPro™	RapidConfigure™	TruTranslation™
EnSigna™	i-Lo™	OCX™	RapidConnect™	UHC™
FACT™	ImpliedDisconnect™	OCXPro™	µSerDes™	UltraFET®
FACT Quiet Series™		OPTOLOGIC®	SILENT SWITCHER®	VCX™
Across the board. Around the world.™		OPTOPLANAR™	SMART START™	
The Power Franchise®		PACMAN™	SPM™	
Programmable Active Droop™		POP™	Stealth™	

DISCLAIMER

FAIRCHILD SEMICONDUCTOR RESERVES THE RIGHT TO MAKE CHANGES WITHOUT FURTHER NOTICE TO ANY PRODUCTS HEREIN TO IMPROVE RELIABILITY, FUNCTION OR DESIGN. FAIRCHILD DOES NOT ASSUME ANY LIABILITY ARISING OUT OF THE APPLICATION OR USE OF ANY PRODUCT OR CIRCUIT DESCRIBED HEREIN; NEITHER DOES IT CONVEY ANY LICENSE UNDER ITS PATENT RIGHTS, NOR THE RIGHTS OF OTHERS.

LIFE SUPPORT POLICY

FAIRCHILD'S PRODUCTS ARE NOT AUTHORIZED FOR USE AS CRITICAL COMPONENTS IN LIFE SUPPORT DEVICES OR SYSTEMS WITHOUT THE EXPRESS WRITTEN APPROVAL OF FAIRCHILD SEMICONDUCTOR CORPORATION. As used herein:

1. Life support devices or systems are devices or systems which, (a) are intended for surgical implant into the body, or (b) support or sustain life, or (c) whose failure to perform when properly used in accordance with instructions for use provided in the labeling, can be reasonably expected to result in significant injury to the user.
2. A critical component is any component of a life support device or system whose failure to perform can be reasonably expected to cause the failure of the life support device or system, or to affect its safety or effectiveness.

PRODUCT STATUS DEFINITIONS

Definition of Terms

Datasheet Identification	Product Status	Definition
Advance Information	Formative or In Design	This datasheet contains the design specifications for product development. Specifications may change in any manner without notice.
Preliminary	First Production	This datasheet contains preliminary data, and supplementary data will be published at a later date. Fairchild Semiconductor reserves the right to make changes at any time without notice in order to improve design.
No Identification Needed	Full Production	This datasheet contains final specifications. Fairchild Semiconductor reserves the right to make changes at any time without notice in order to improve design.
Obsolete	Not In Production	This datasheet contains specifications on a product that has been discontinued by Fairchild semiconductor. The datasheet is printed for reference information only.