



Title	<i>Reference Design Report for 1.6 W, Linear Replacement Adapter with 10 kV surge withstand</i>
Specification	85–265 VAC Input, 7.7 V, 210 mA Output
Application	Cordless Phone Adapter
Author	Power Integrations Applications Department
Document Number	RDR-83
Date	Sept 29, 2006
Revision	1.0

Summary and Features

- Highly efficient, low cost switching solution
 - Replacement for existing AC line transformer based design
- Designed to withstand 10 kV common-mode surges
 - Ideal for applications connected to telephone network
- *EcoSmart*[®] – meets all existing and proposed harmonized energy efficiency standards including: CECP (China), CEC, EPA, AGO, European Commission
 - No-load power consumption <220 mW at 265 VAC
 - 61.3% active-mode efficiency (exceeds requirement of 53.2%)
- Integrated *LinkSwitch* safety/reliability features:
 - Accurate ($\pm 5\%$), auto-recovering, hysteric thermal shutdown function maintains safe PCB temperatures under all conditions
 - Auto-restart protects against output short circuits and open feedback loops
- Meets EN55022 and CISPR-22 Class B conducted EMI with >15 dB μ V margin
- Meets IEC61000-4-5 Class 4 AC line surge

The products and applications illustrated herein (including circuits external to the products and transformer construction) may be covered by one or more U.S. and foreign patents or potentially by pending U.S. and foreign patent applications assigned to Power Integrations. A complete list of Power Integrations' patents may be found at www.powerint.com.

Table Of Contents

1	Introduction.....	3
2	Power Supply Specification	4
2.1	Typical Output Characteristic and limits	5
3	Schematic.....	6
4	Circuit Description	7
4.1	Input Stage	7
4.2	LinkSwitch-LP.....	7
4.3	Feedback.....	8
4.4	Output Rectification	9
5	PCB Layout	10
6	Bill Of Materials	11
7	Transformer Specification.....	12
7.1	Electrical Diagram	12
7.2	Electrical Specifications.....	12
7.3	Materials.....	12
7.4	Transformer Build Diagram	13
7.5	Transformer Construction.....	13
8	Design Spreadsheets	14
9	Performance Data	19
9.1	Efficiency	19
9.1.1	Active Mode ENERGY STAR / CEC Efficiency Measurement Data.....	20
9.2	No-load Input Power.....	21
9.3	Available Standby Output Power	21
9.4	Regulation	22
9.4.1	VI Curve vs. Input Voltage.....	22
10	Thermal Performance	23
10.1	LNK562 Temperature Rise.....	23
10.2	Thermal Image	23
11	Waveforms.....	24
11.1	Drain Voltage and Current, Normal Operation.....	24
11.2	Output Voltage Start-up Profile.....	24
11.3	Drain Voltage and Current Start-up Profile	25
11.4	Load Transient Response (50% to 100% Load Step)	26
11.5	Output Ripple Measurements.....	27
11.5.1	Ripple Measurement Technique	27
11.5.2	Measurement Results	28
12	Line Surge.....	29
13	Conducted EMI	30
14	Revision History.....	32

Important Note:

Although this board is designed to satisfy safety isolation requirements, the engineering prototype has not been agency approved. Therefore, all testing should be performed using an isolation transformer to provide the AC input to the prototype board.



1 Introduction

This reference design report describes a switched-mode power supply that was designed to replace line frequency transformer based solutions. The supply uses a member of the *LinkSwitch-LP* family of devices, and is capable of withstanding common-mode line surges of up to 10 kV. That is often a requirement for applications that connect to a telephone line, such as modems, cordless phones and answering machines.

The report includes the power supply specification, a circuit diagram, a bill of materials, transformer documentation, a printed circuit layout board, and performance data.

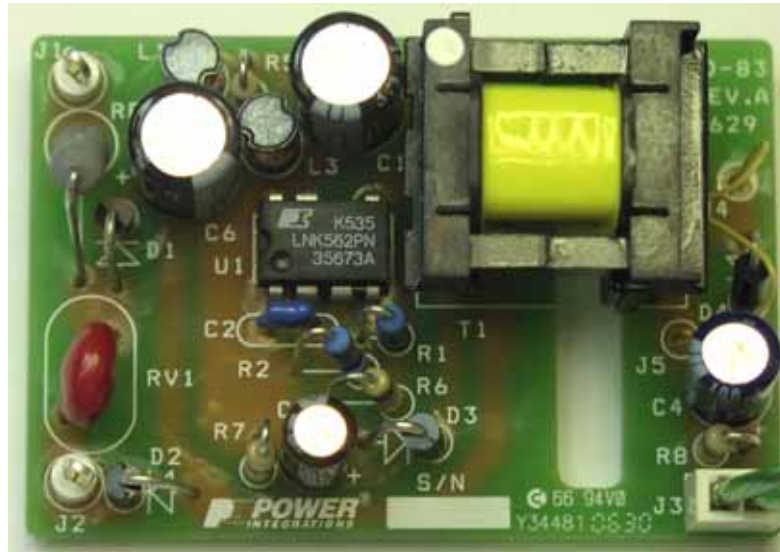

Figure 1 – Populated Circuit Board Photograph.



2 Power Supply Specification

Description	Symbol	Min	Typ	Max	Units	Comment
Input						
Voltage	V_{IN}	85		265	VAC	2 Wire – no P.E.
Frequency	f_{LINE}	47	50/60	64	Hz	
No-load Input Power (230 VAC)				0.3	W	
Output						
Output Voltage 1	V_{OUT1}	6.7	7.7	8.7	V	20 MHz bandwidth
Output Ripple Voltage 1	$V_{RIPPLE1}$			400	mV	
Output Current 1	I_{OUT1}	0.21	0.21		A	
Total Output Power						
Continuous Output Power	P_{OUT}	1.4	1.6		W	
No Load Output Voltage				11	V	
Efficiency						
Full Load	η	60			%	Measured at P_{OUT} 25 °C
Required average efficiency at 25, 50, 75 and 100 % of P_{OUT}	η_{CEC}	53			%	Per ENERGY STAR / CEC requirements
Environmental						
Conducted EMI		Meets CISPR22B / EN55022B				
Safety		Designed to meet IEC950, UL1950 Class II				
Surge						1.2/50 μ s surge, IEC 1000-4-5, Series Impedance: Differential Mode: 2 Ω Common Mode: 12 Ω
Differential Mode		2			kV	
Common Mode		6	10		kV	
Surge		2			KV	100 kHz ring wave, 500 A short circuit current, differential
Ambient Temperature	T_{AMB}	0		50	°C	Free convection, sea level



2.1 Typical Output Characteristic and Limits

The following diagram shows the output characteristic of the *LinkSwitch-LP* solution and that of the linear transformer solution it was designed to replace. As can be seen, the *LinkSwitch-LP* solution provides a more controlled output characteristic.

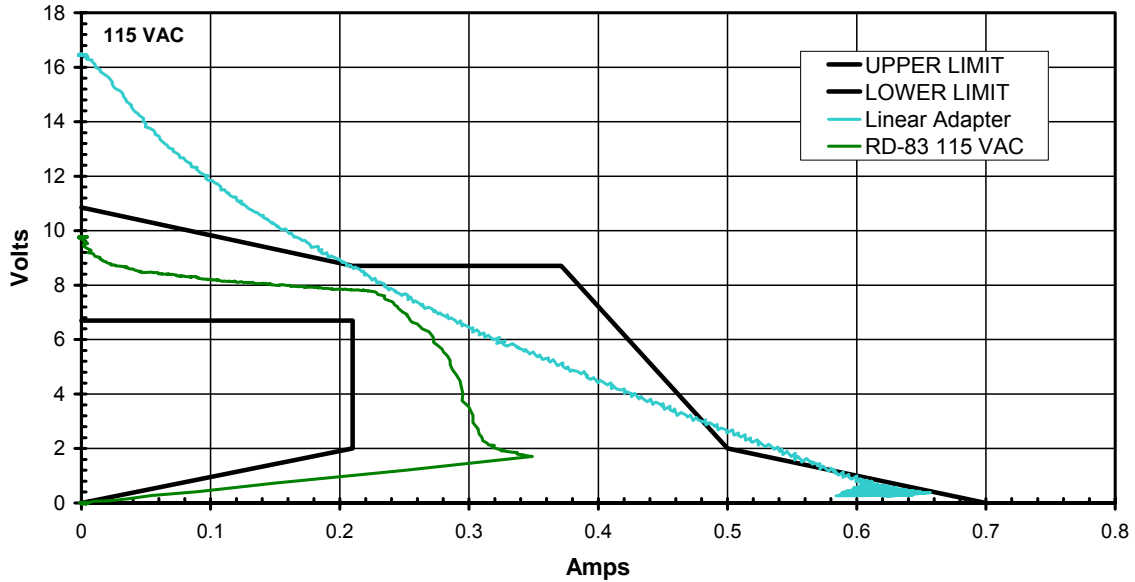

Figure 2 – Output Characteristic Comparison and Limits.



3 Schematic

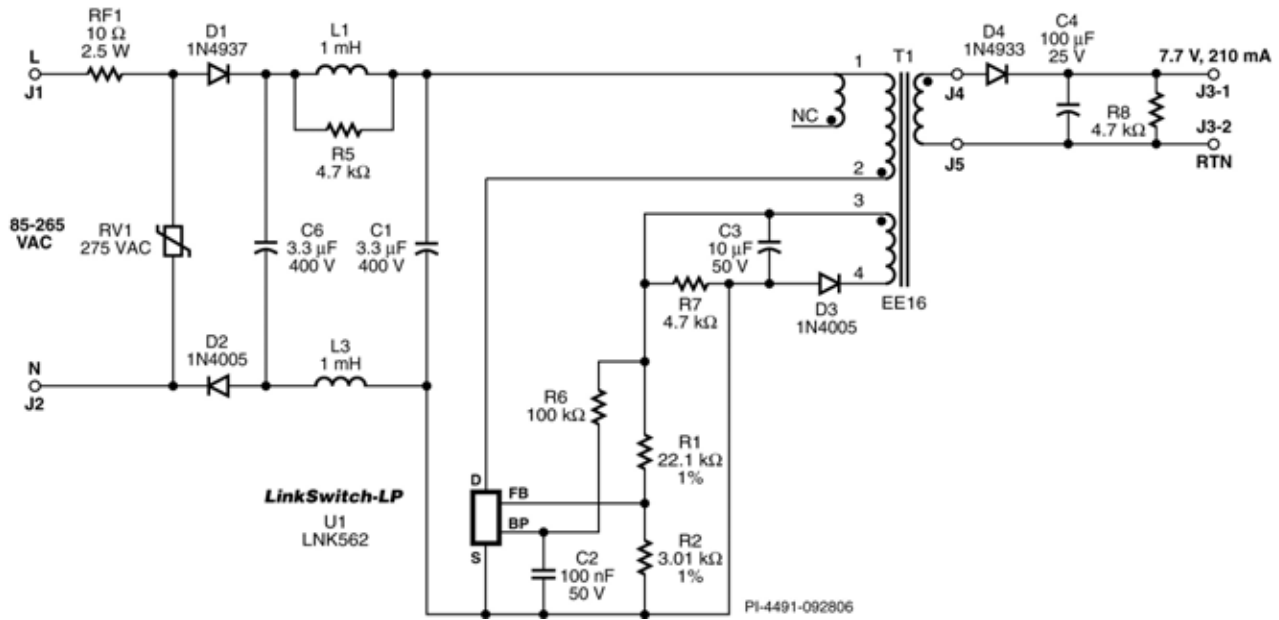

Figure 3 – Schematic.



4 Circuit Description

4.1 Input Stage

Components C1, C6, L1 and L3 comprise a balanced π filter. Resistor R5 dampens low frequency conducted EMI. The supply needs no Y1-type capacitor (that normally bridges the primary to secondary isolation barrier) due to U1's frequency jitter function and the *E-Shield*[™] techniques used in the design of transformer T1. This minimizes audible noise in applications connected to a phone line, by eliminating a path for line frequency leakage currents to pass onto the output of the supply. The supply easily meets EN55022B conducted EMI limits, with more than 15 dB μ V of margin.

A metal oxide varistor (RV1) and a wire wound resistor (RF1) attenuate differential line surges. The varistor is required to meet the 2 kV differential surge requirement. In applications where only 1 kV of surge immunity is required, RV1 can be eliminated. The wire wound resistor (RF1) must be able to withstand high transient dissipation from initial inrush current (when AC power is applied) and during line surges.

4.2 LinkSwitch-LP

The *LinkSwitch-LP* family of ICs were designed to replace linear transformer solutions in low-power charger and adapter applications. Feedback to the LNK562P IC (U1) is derived from a resistor divider (R1 and R2) across the bias supply (D3 and C3), which lowers cost by eliminating the need for an optocoupler.

Linear transformers typically use thermal fuses (over temperature cut-outs) for overload protection. However, once a thermal fuse trips, the entire charger or adapter must be thrown away, since thermal fuses cannot be reset or repaired. Latching thermal shutdown functions are typically used in ringing choke converter (RCC) based supplies. However, AC input power must be removed and reapplied to reset most thermal latches. Since customers typically don't know this, they often return good units they thought were defective, simply because the thermal latch tripped and shut the unit off. The *LinkSwitch-LP* family's hysteretic thermal shutdown function has a very tight tolerance (142 °C, $\pm 5\%$), and automatically restarts the power supply once the IC temperature drops below the lower temperature threshold. This maintains the average PCB temperature at a safe level under all conditions, and reduces the return rate of good units from the field. The auto-recovery feature also eliminates the noise sensitivity and component aging problems associated with discrete latching circuits.

Pin 6 is eliminated from the IC package to extend the creepage distance between the DRAIN pin and all other low voltage pins; both at the package and on the PCB. This reduces the likelihood that tracking or arcing will occur due to moisture or board surface contamination (from dust and dirt), which improves reliability in high humidity and high pollution environments. During an output short circuit or an open loop condition, the *LinkSwitch-LP*'s auto-restart function limits output power to about 12% of the maximum. This protects both the load and the supply during prolonged overload conditions.



The *LinkSwitch-LP* family of ICs are self-biased, via a high-voltage current source that is internally connected to the DRAIN pin of the package. A capacitor (C2) connected to the BYPASS (BP) pin of the IC provides energy storage and local decoupling of the internal chip power. To further reduce no-load power consumption, a resistor can be used to provide operating current to the IC from the bias winding (once the power supply is operating). In this design, the bias winding voltage is about 14 V and the BP pin voltage is 5.8 V. Therefore, R6 (100 k Ω) provides about 80 μ A of current to the BP pin. If the value of R6 were reduced, it could provide the entire 220 μ A of IC supply current, which would further reduce the no-load power consumption of the supply.

The worst-case, no-load power consumption of this supply is approximately 200 mW at an input voltage of 265 VAC, which is well below the maximum limit of most energy efficiency standards. Heat generation is also kept to a minimum in this design, given the high operating efficiency at all line and load conditions.

4.3 Feedback

The output voltage of the supply is regulated based on feedback from the primary-side bias supply. The bias winding voltage is rectified and filtered by D3 and C3. The leakage inductance between the output winding and the bias winding induces error in the bias winding voltage. Using a standard rectifier diode for D3 makes the bias winding voltage more accurately track the output voltage. Resistor R7 preloads (3 mA) the output of the bias supply, which further reduces the error and also limits the no-load output voltage.

A resistor divider (R1 and R2) provides the feedback voltage to the FB pin of U1. The values of R1 and R2 are selected so that when the output voltage is at the desired nominal value, the voltage on the FB pin is 1.69 V, and about 70 μ A flows into the FB pin.

The *LinkSwitch-LP* family of devices use ON/OFF control to regulate the output of the supply. During constant voltage (CV) operation, switching cycles are skipped when the current into the FB pin exceeds 70 μ A. As the load on the output of the supply reduces, more switching cycles are skipped. As the load increases, fewer cycles are skipped. The result is that the average or effective switching frequency varies with the load. This makes the efficiency fairly consistent over the entire load range, since the switching losses scale with the load on the output of the supply.

When the load on the output of the supply reaches its maximum power capability, no switching cycles are skipped. If the load is increased beyond that point, the output voltage of the supply will start to drop. As the output voltage drops, the voltage on the FB pin also drops, and the IC linearly reduces its switching frequency. This keeps the output current from increasing significantly. Once the FB pin voltage falls below 0.8 V for more than 100 ms, all *LinkSwitch-LP* devices enter an auto-restart mode. While in auto-restart, the controller enables MOSFET switching for 100 ms. If the FB pin voltage does not exceed 0.8 V during the 100 ms, the controller disables MOSFET switching. MOSFET switching is alternately enabled and disabled at a duty cycle of about 12% until the fault condition clears. This protects both the supply and the load.



4.4 Output Rectification

The transformer secondary winding is rectified by D4 and filtered by C4. A small preload resistor (R8) limits the no-load output voltage. Decreasing the value of the preload resistor will further reduce the no-load output voltage, at the expense of increasing the no-load input power consumption. In this design, a fast diode (rather than an ultra-fast) was used for D4 to lower cost and EMI emissions.



5 PCB Layout

During a common mode surge, the specified surge voltage appears across the isolation barrier. Elimination of the optocoupler and Y1-type capacitor in the design allowed the necessary PCB clearance and creepage distance to be obtained, so that the supply can withstand a 10 kV surge without resorting to expensive, special components.

To increase the creepage and clearance, the standard triple insulated wire used for the secondary winding was terminated as flying leads that were soldered directly into the PCB, instead of being terminated to transformer bobbin pins.

A 0.185 inch long, 4.7 mm wide slot was placed along the isolation barrier. Additionally, the primary and secondary traces are separated by 0.4 inches (10 mm). A spark gap was added across the isolation barrier (marked as points (B) in Figure 4), so that any arcing that might occur would take place at a designated point with a well defined path. On the primary side of the isolation barrier, the spark gap trace returns directly to C6, which keeps surge currents away from the low-voltage pins of U1. Two additional spark gaps were placed across L1 and L3, to prevent the breakdown of insulation on those parts. **Note:** During 10 kV common mode surge testing, no arcing occurred across any of the spark gaps.

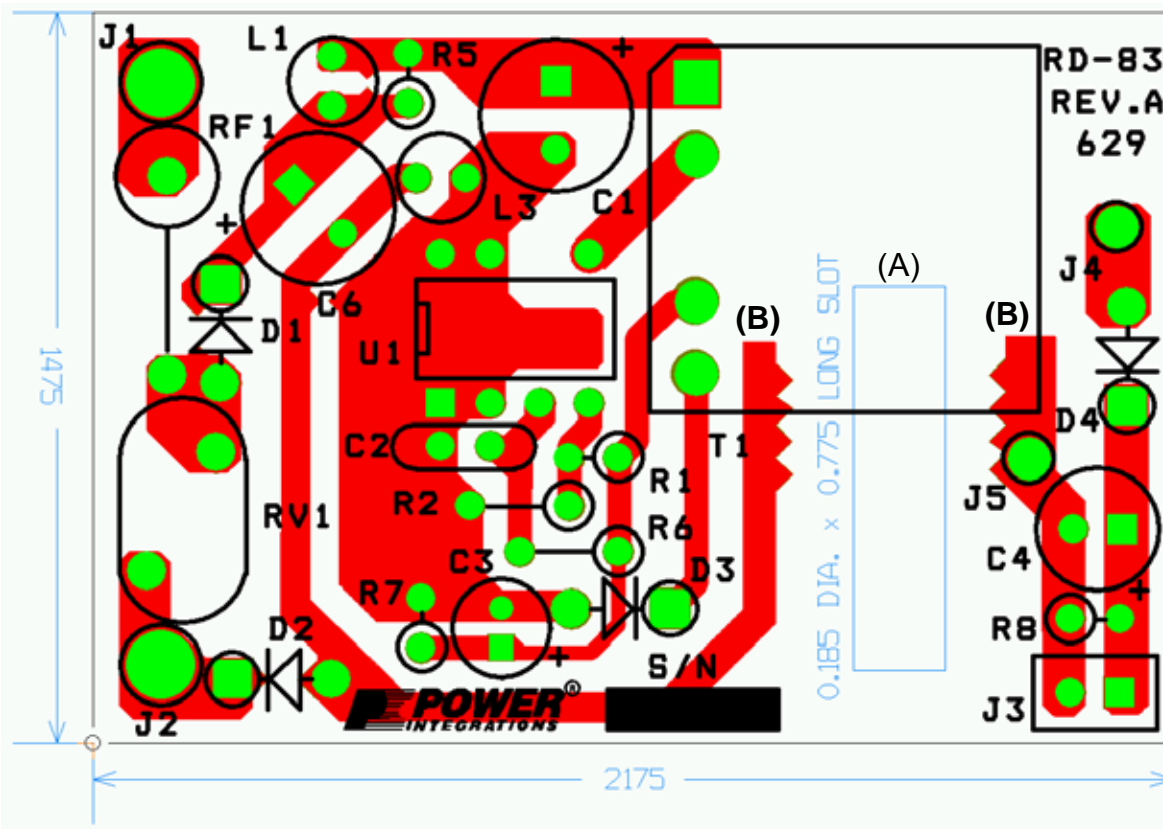

Figure 4 – RD83 Printed Circuit Layout (2.175" x 1.475" / 55.25 mm x 37.47 mm).



6 Bill Of Materials

Item	Qty	Ref Des	Description	Manufacturer	Manufacturer Part #
1	2	C1, C6	3.3 μ F, 400 V, Electrolytic, (8 x 11.5)	Nippon Chemi-Con	ESMQ401ELL3R3MHB5D
2	1	C2	100 nF, 50 V, Ceramic, Z5U	Panasonic	ECU-S1H104MEA
3	1	C3	10 μ F, 50 V, Electrolytic, Gen. Purpose, (5 x 11)	Nippon Chemi-Con	EKMG500ELL100ME11D
4	1	C4	100 μ F, 25 V, Electrolytic, Low ESR, 250 m Ω , (6.3 x 11.5)	Nippon Chemi-Con	ELXZ250ELL101MFB5D
5	1	D1	600 V, 1 A, Fast Recovery Diode, 200 ns, DO-41	Vishay	1N4937
6	2	D2, D3	600 V, 1 A, Rectifier, DO-41	Vishay	1N4005
7	1	D4	50 V, 1 A, Fast Recovery, 200 ns, DO-41	Vishay	1N4933
8	2	J1, J2	Test Point, WHT, THRU-HOLE MOUNT	Keystone	5012
9	1	J3	Output cord, 6 ft, 22 AWG, 0.25 Ω , 2.1 mm connector	Generic	
10	2	J4, J5	PCB Terminal Hole, 22 AWG	N/A	N/A
11	2	L1, L3	1 mH, 0.15 A, Ferrite Core	Tokin	SBCP-47HY102B
12	1	R1	22.1 k Ω , 1%, 1/4 W, Metal Film	Yageo	MFR-25FBB-22K1
13	1	R2	3.01 k Ω , 1%, 1/4 W, Metal Film	Yageo	MFR-25FBB-3K01
14	3	R5, R7, R8	4.7 k Ω , 5%, 1/4 W, Carbon Film	Yageo	CFR-25JB-4K7
15	1	R6	100 k Ω , 5%, 1/4 W, Carbon Film	Yageo	CFR-25JB-100K
16	1	RF1	10 Ω , 2.5 W, Fusible/Flame Proof Wire Wound	Vitrohm	CRF253-4 10R
17	1	RV1	275 V, 23 J, 7 mm, RADIAL	Littlefuse	V275LA4
18	1	T1	Custom Transformer Core: EE16, See Power Integration's document EPR-83 for Transformer Specification	Hical Magnetics CWS Santronics	SIL6043 EP-83 SNX1388
			Bobbin: Horizontal Extended Creepage 5+5 pin	Taiwan Shulin www.bobbin.com.tw	TF-1613
19	1	U1	<i>LinkSwitch-LP</i> , LNK562P, DIP-8B	Power Integrations	LNK562P

Note: For reduced line frequency ripple at 85 VAC, increase the values of C1 and C6 to 4.7 μ F.



7 Transformer Specification

7.1 Electrical Diagram

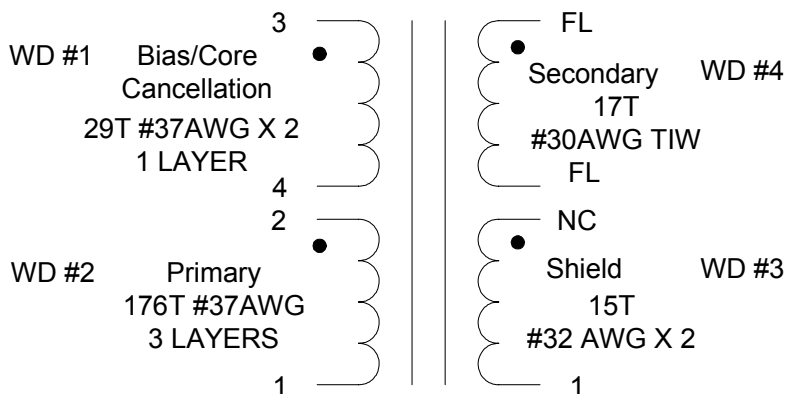

Figure 5 –Transformer Electrical Diagram.

7.2 Electrical Specifications

Electrical Strength	1 second, 60 Hz, from Pins 1-4 to Flying leads	6000 VAC
Primary Inductance	Pins 1-2, all other windings open, measured at 100 kHz, 0.4 VRMS	3.5 mH, $\pm 10\%$
Resonant Frequency	Pins 1-2, all other windings open	250 kHz (Min.)
Primary Leakage Inductance	Pins 1-2, with flying leads shorted, measured at 100 kHz, 0.4 VRMS	115 μ H (Max.)

7.3 Materials

Item	Description
[1]	Core: PC40EE16-Z, TDK or equivalent gapped for AL of 114 nH/T ² . Gap approx. 0.2 mm.
[2]	Bobbin: EE16 Horizontal 10 pin Taiwan Shulin TF-1613 or equivalent
[3]	Magnet Wire: #37 AWG
[4]	Magnet Wire: #32 AWG
[5]	Triple Insulated Wire: #30 AWG
[6]	Tape, 3M 1298 Polyester Film, 2.0 Mils thick, 8 mm wide
[7]	Varnish



7.4 Transformer Build Diagram

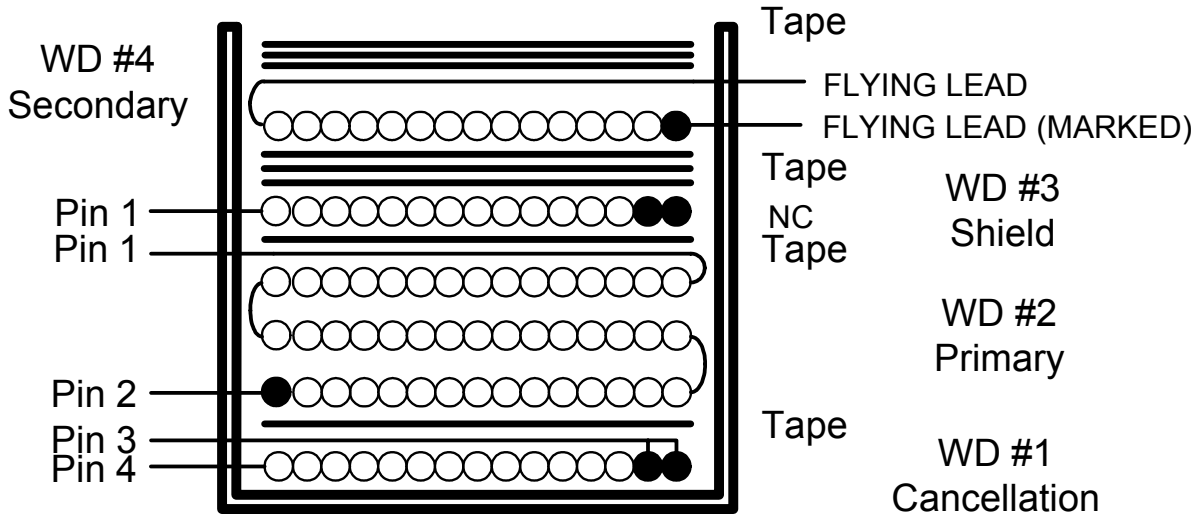

Figure 6 – Transformer Build Diagram.

7.5 Transformer Construction

Bobbin orientation is such that primary pins are on the left hand side of the winding spindle

WD1 Cancellation and Bias Winding	Primary pin side of the bobbin oriented to the left hand side. Temporarily start at pin 7. Wind 29 bifilar turns of item [3] from right to left. Wind with tight tension evenly across the bobbin. Terminate finish on pin 4. Take the end of the winding that was started on pin 7 and terminate it on pin 3.
Insulation	1 Layer of tape [6] for insulation.
WD #2 Primary Winding	Start at Pin 2. Wind 58 turns of item [3] from left to right. Then wind 59 turns on the next layer from right to left. Wind 59 turns from left to right on the third layer. Wind with tight tension evenly across the bobbin. Bring the wire across the bobbin and terminate the finish on pin 1.
Insulation	Use one layer of tape [6] for basic insulation.
WD #3 Shield Winding	Temporarily start at Pin 7. Wind 15 bifilar turns of item [4]. Wind from right to left with tight tension across the entire bobbin width. Terminate on pin 1. Cut the wire from Pin 7 and leave it unconnected.
Insulation	Use three layers of tape [6] for basic insulation.
WD #4 Secondary Winding	Temporarily start at Pin 7 (allow 1" of wire at the start for the flying lead). Wind 17 turns of item [5] from right to left with tight tension. Allow 1" of wire at the finish for the flying lead, at the right side of bobbin. Remove the start from pin 7 and mark. Exit start at right hand side of the bobbin.
Outer insulation	Wrap windings with three layers of tape [6].
Gap Core	Gap core such that the inductance between pins 1 & 2 is 3.5 mH ±10%. The gap is approximately 0.2 mm.
Core Assembly and trim flying leads	Assemble and secure the core halves. Trim flying leads to 0.65"±0.05". Tin leads 0.15"±0.05". Cut bobbin pins 5,6,7 and 8.
Varnish	Dip varnish assembly with item [7].



8 Design Spreadsheets

ACDC_LinkSwitch-LP_053106; Rev.1.12; Copyright Power Integrations 2006	INPUT	INFO	OUTPUT	UNIT	ACDC_LinkSwitch-LP_053106_Rev1-12.xls; LinkSwitch-LP Continuous/Discontinuous Flyback Transformer Design Spreadsheet
ENTER APPLICATION VARIABLES					RDR-83
VACMIN	85			Volts	Minimum AC Input Voltage
VACMAX	265			Volts	Maximum AC Input Voltage
fL	50			Hertz	AC Mains Frequency
VO	7.70			Volts	Output Voltage (main) measured at the end of output cable (For CV/CC designs enter typical CV tolerance limit)
IO	0.21			Amps	Power Supply Output Current (For CV/CC designs enter typical CC tolerance limit)
Constant Voltage / Constant Current Output	YES		CVCC	Volts	Choose "YES" from the 'CV/CC output' drop down box at the top of this spreadsheet for approximate CV/CC output. Choose "NO" for CV only output
Output Cable Resistance	0.25		0.25	Ohms	Enter the resistance of the output cable (if used)
PO			1.63	Watts	Output Power (VO x IO + dissipation in output cable)
Feedback Type	BIAS		Bias Winding		Choose 'BIAS' for Bias winding feedback and 'OPTO' for Optocoupler feedback from the 'Feedback Type' drop down box at the top of this spreadsheet
Add Bias Winding	YES		Yes		Choose 'YES' in the 'Bias Winding' drop down box at the top of this spreadsheet to add a Bias winding. Choose 'NO' to continue design without a Bias winding. Addition of Bias winding can lower no load consumption
Clampless design	YES		Clampless		Choose 'YES' from the 'clampless Design' drop down box at the top of this spreadsheet for a clampless design. Choose 'NO' to add an external clamp circuit. Clampless design lowers the total cost of the power supply
n	0.65		0.65		Efficiency Estimate at output terminals. For CV only designs enter 0.7 if no better data available
Z	0.35		0.35		Loss Allocation Factor (Secondary side losses / Total losses)
tC	2.90			mSeconds	Bridge Rectifier Conduction Time Estimate
CIN	9.40			UFarads	Input Capacitance
Input Rectification Type	H			H	Choose H for Half Wave Rectifier and F for Full Wave Rectification from the 'Rectification' drop down box at the top of this spreadsheet
ENTER LinkSwitch-LP VARIABLES					
LinkSwitch-LP	LNK562				LinkSwitch-LP device
Chosen Device		LNK562			
ILIMITMIN			0.124	Amps	Minimum Current Limit
ILIMITMAX			0.146	Amps	Maximum Current Limit
fSmin			61000	Hertz	Minimum Device Switching Frequency



I ² f _{MIN}			1099	A ² Hz	I ² f Minimum value (product of current limit squared and frequency is trimmed for tighter - tolerance)
I ² f _{TYP}			1221	A ² Hz	I ² f typical value (product of current limit squared and frequency is trimmed for tighter tolerance)
VOR	90.00		90	Volts	Reflected Output Voltage
VDS			10	Volts	LinkSwitch-LP on-state Drain to Source Voltage
VD	0.90		0.9	Volts	Output Winding Diode Forward Voltage Drop
KP			1.99		Ripple to Peak Current Ratio (0.9<KRP<1.0 : 1.0<KDP<6.0)

ENTER TRANSFORMER CORE/CONSTRUCTION VARIABLES

Core Type	EE16		EE16		User-Selected transformer core
Core		EE16		P/N:	PC40EE16-Z
Bobbin		EE16_B OBBIN		P/N:	EE16_BOBBIN
AE			0.192	cm ²	Core Effective Cross Sectional Area
LE			3.5	cm	Core Effective Path Length
AL			1140	nH/T ²	Ungapped Core Effective Inductance
BW			8.6	mm	Bobbin Physical Winding Width
M			0	mm	Safety Margin Width (Half the Primary to Secondary Creepage Distance)
L			2		Number of primary layers
NS			17		Number of Secondary Turns
NB			44		Number of Bias winding turns
VB			22.26	Volts	Bias Winding Voltage
R1			37.47	k-ohms	Resistor divider component between bias winding and FB pin of LinkSwitch-LP
R2			3.00	k-ohms	Resistor divider component between FB pin of LinkSwitch-LP and primary RTN
Recommended Bias Diode			1N4003		Place this diode on the return leg of the bias winding for optimal EMI. See LinkSwitch-LP Design guide for more information

DC INPUT VOLTAGE PARAMETERS

V _{MIN}			73	Volts	Minimum DC Input Voltage
V _{MAX}			375	Volts	Maximum DC Input Voltage

CURRENT WAVEFORM SHAPE PARAMETERS

D _{MAX}			0.45		Maximum Duty Cycle
I _{AVG}			0.04	Amps	Average Primary Current
I _P			0.12	Amps	Minimum Peak Primary Current
I _R			0.12	Amps	Primary Ripple Current
I _{RMS}			0.05	Amps	Primary RMS Current

TRANSFORMER PRIMARY DESIGN PARAMETERS

LP			3486	uHenries	Typical Primary Inductance. +/- 10%
LP_TOLERANCE			10	%	Primary inductance tolerance



NP			178		Primary Winding Number of Turns
ALG			110	nH/T ²	Gapped Core Effective Inductance
BM			1490	Gauss	Maximum Operating Flux Density, BM<1500 is recommended
BAC			745	Gauss	AC Flux Density for Core Loss Curves (0.5 X Peak to Peak)
ur			1654		Relative Permeability of Ungapped Core
LG			0.20	Mm	Gap Length (Lg > 0.1 mm)
BWE			17.2	Mm	Effective Bobbin Width
OD			0.10	Mm	Maximum Primary Wire Diameter including insulation
INS			0.02	Mm	Estimated Total Insulation Thickness (= 2 * film thickness)
DIA			0.07	Mm	Bare conductor diameter
AWG			41	AWG	Primary Wire Gauge (Rounded to next smaller standard AWG value)
CM			8	Cmils	Bare conductor effective area in circular mils
CMA			150	Cmils/Amp	Primary Winding Current Capacity (150 < CMA < 500)

TRANSFORMER SECONDARY DESIGN PARAMETERS					
Lumped parameters					
ISP			1.30	Amps	Peak Secondary Current
ISRMS			0.47	Amps	Secondary RMS Current
IRIPPLE			0.42	Amps	Output Capacitor RMS Ripple Current
CMS			93	Cmils	Secondary Bare Conductor minimum circular mils
AWGS			30	AWG	Secondary Wire Gauge (Rounded up to next larger standard AWG value)
DIAS			0.26	Mm	Secondary Minimum Bare Conductor Diameter
ODS			0.51	Mm	Secondary Maximum Outside Diameter for Triple Insulated Wire
INSS			0.12	Mm	Maximum Secondary Insulation Wall Thickness

VOLTAGE STRESS PARAMETERS					
VDRAIN				- Volts	Peak Drain Voltage is highly dependent on Transformer capacitance and leakage inductance. Please verify this on the bench and ensure that it is below 650 V to allow 50 V margin for transformer variation.
PIVS			44	Volts	Output Rectifier Maximum Peak Inverse Voltage

TRANSFORMER SECONDARY DESIGN PARAMETERS (MULTIPLE OUTPUTS)					
1st output					
VO1			7.7	Volts	Main Output Voltage (if unused, defaults to single output design)
IO1			0.211	Amps	Output DC Current
PO1			1.63	Watts	Output Power
VD1			0.9	Volts	Output Diode Forward Voltage Drop
NS1			17.00		Output Winding Number of Turns



ISRMS1			0.470	Amps	Output Winding RMS Current
IRIPPLE1			0.42	Amps	Output Capacitor RMS Ripple Current
PIVS1			44	Volts	Output Rectifier Maximum Peak Inverse Voltage
Recommended Diodes			SB160, 11DQ06		Recommended Diodes for this output
Pre-Load Resistor			3	k-Ohms	Recommended value of pre-load resistor
CMS1			94	Cmils	Output Winding Bare Conductor minimum circular mils
AWGS1			30	AWG	Wire Gauge (Rounded up to next larger standard AWG value)
DIAS1			0.26	mm	Minimum Bare Conductor Diameter
ODS1			0.51	mm	Maximum Outside Diameter for Triple Insulated Wire

2nd output					
VO2				Volts	Output Voltage
IO2				Amps	Output DC Current
PO2			0.00	Watts	Output Power
VD2			0.7	Volts	Output Diode Forward Voltage Drop
NS2			1.38		Output Winding Number of Turns
ISRMS2			0.000	Amps	Output Winding RMS Current
IRIPPLE2			0.00	Amps	Output Capacitor RMS Ripple Current
PIVS2			3	Volts	Output Rectifier Maximum Peak Inverse Voltage
Recommended Diode					Recommended Diodes for this output
CMS2			0	Cmils	Output Winding Bare Conductor minimum circular mils
AWGS2				AWG	Wire Gauge (Rounded up to next larger standard AWG value)
DIAS2				mm	Minimum Bare Conductor Diameter
ODS2				mm	Maximum Outside Diameter for Triple Insulated Wire

3rd output					
VO3				Volts	Output Voltage
IO3				Amps	Output DC Current
PO3			0.00	Watts	Output Power
VD3			0.7	Volts	Output Diode Forward Voltage Drop
NS3			1.38		Output Winding Number of Turns
ISRMS3			0.000	Amps	Output Winding RMS Current
IRIPPLE3			0.00	Amps	Output Capacitor RMS Ripple Current
PIVS3			3	Volts	Output Rectifier Maximum Peak Inverse Voltage
Recommended Diode					Recommended Diodes for this output
CMS3			0	Cmils	Output Winding Bare Conductor minimum circular mils
AWGS3				AWG	Wire Gauge (Rounded up to next larger standard AWG value)
DIAS3				mm	Minimum Bare Conductor Diameter
ODS3				mm	Maximum Outside Diameter for Triple Insulated Wire



Total power			1.63	Watts	Total Output Power
Negative Output			N/A		If negative output exists enter Output number; eg: If VO2 is negative output, enter 2



9 Performance Data

All measurements performed at room temperature, 60 Hz input frequency.

9.1 Efficiency

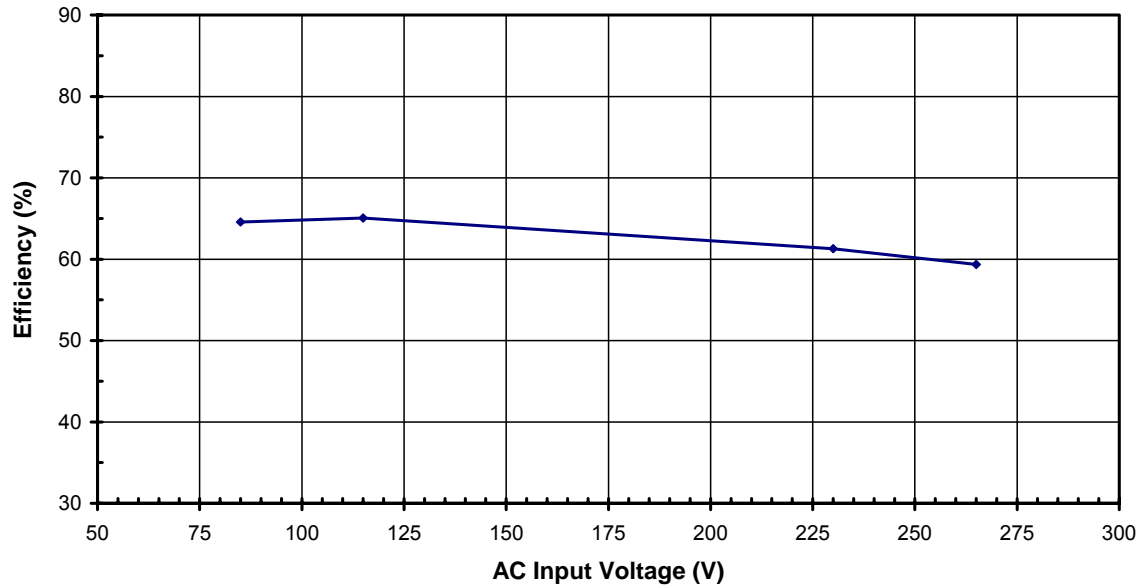

Figure 7 – Efficiency vs. Input Voltage, Room Temperature, 60 Hz.



9.1.1 Active Mode ENERGY STAR / CEC Efficiency Measurement Data

All single output cordless phone adapters manufactured for sale in California after July 1st, 2007 must meet the CEC requirement for minimum active mode efficiency and no-load input power. Cordless phone adapters must also meet this specification on a voluntary basis to be able to display the ENERGY STAR logo. Minimum active mode efficiency is defined as the average efficiency of 25, 50, 75 and 100% of rated output power, based on the nameplate output power:

ENERGY STAR / CEC Active Mode Efficiency Specification

Nameplate Output (P_o)	Minimum Efficiency in Active Mode of Operation
< 1 W	$0.49 \times P_o$
≥ 1 W to ≤ 49 W	$0.09 \times \ln(P_o) + 0.49$ [ln = natural log]
> 49 W	$0.84 \times P_o$

For adapters that are single input voltage only, the measurement is made at the rated, single nominal input voltage (115 VAC or 230 VAC). For universal input adapters, the measurement for ENERGY STAR qualification is made at both nominal input voltages (115 VAC and 230 VAC); for CEC qualification, measurements are made at 115 VAC only. To meet the standard, the measured average efficiency (or efficiencies for universal input supplies) must be greater than or equal to the efficiency specified by the CEC / ENERGY STAR standard.

Percent of Full Load	Efficiency (%)	
	115 VAC	230 VAC
25	61.0	56.1
50	65.4	62.6
75	66.5	63.6
100	67.4	62.9
Average	65.1	61.3
CEC specified minimum average efficiency (%)	53.2	

More states within the USA and other countries are adopting this standard. For the latest information, please visit the PI Green Room at:

<http://www.powerint.com/greenroom/regulations.htm>



9.2 No-load Input Power

The supply easily meets the ENERGY STAR / CEC and European no-load power consumption specifications of 0.5 W and 0.3 W (respectively).

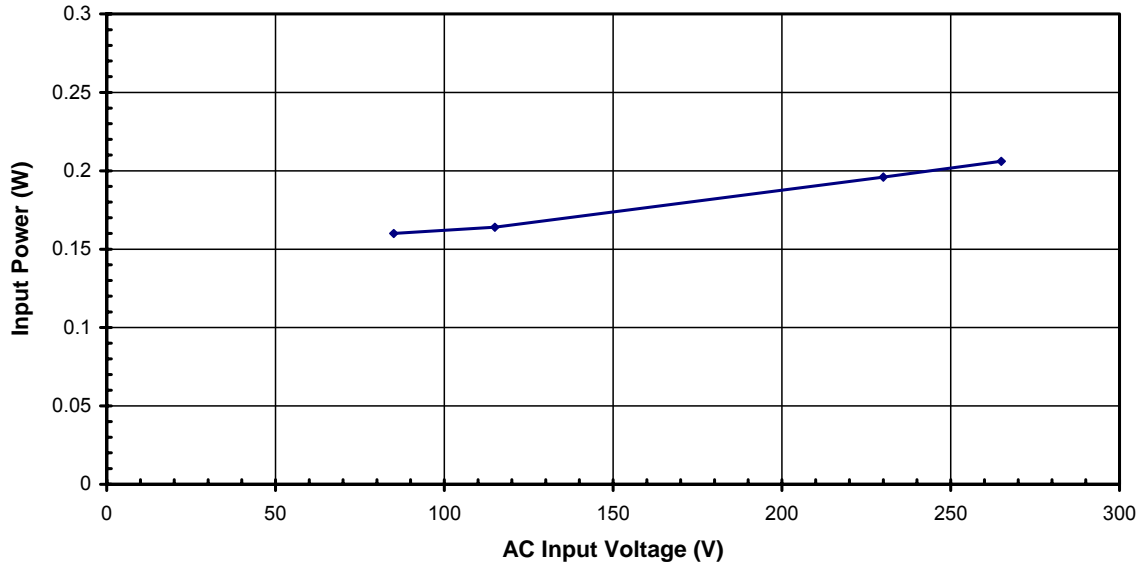

Figure 8 – No Load Input Power vs. Input Line Voltage, Room Temperature, 60 Hz.

9.3 Available Standby Output Power

The supply provides >500 mW of available output power, at an input power of 1 W.

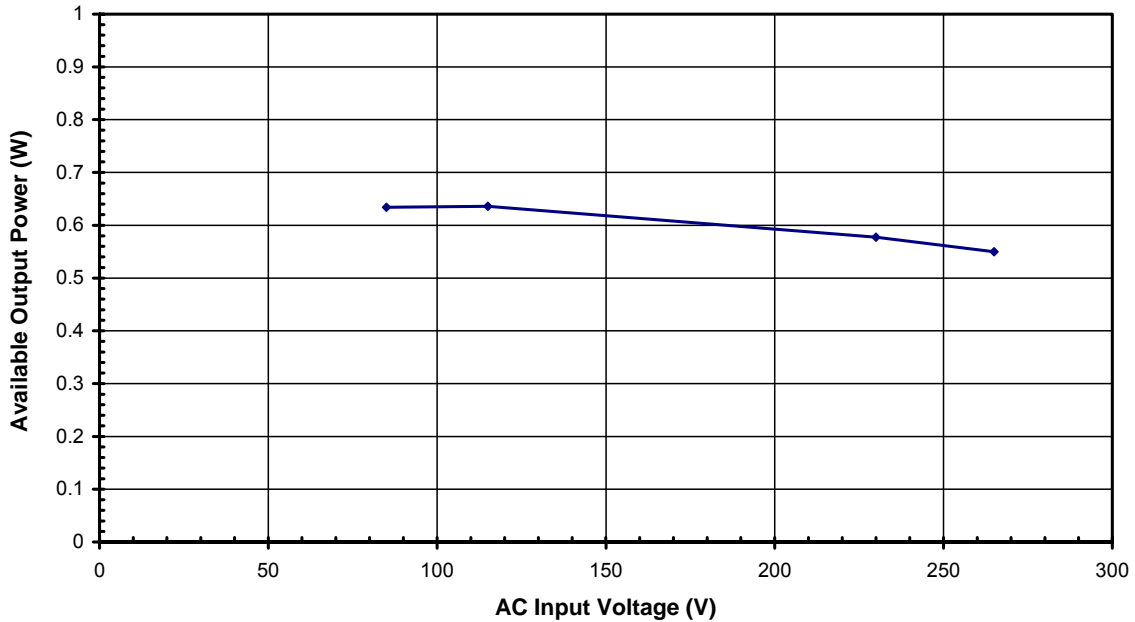

Figure 9 – Available Output Power at 1 Watt Input Power vs. Input Voltage.



9.4 Regulation

9.4.1 VI Curve vs. Input Voltage

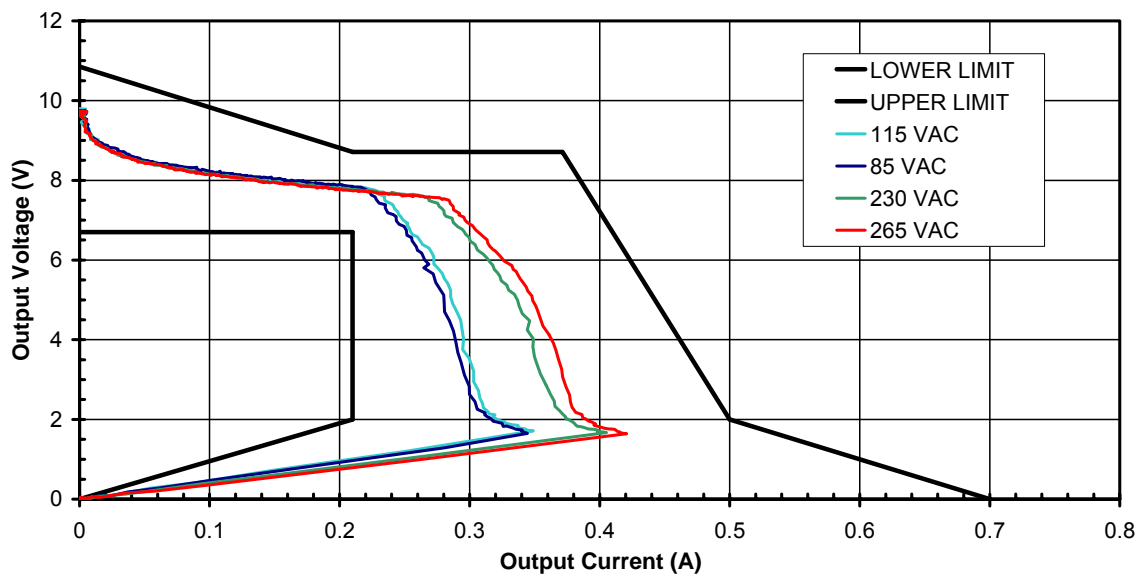

Figure 10 – Output VI Curve, Room Temperature.

10 Thermal Performance

10.1 LNK562 Temperature Rise

The RD-83 was installed within a sealed plastic enclosure, placed inside a sealed cardboard box, and placed into a thermal chamber at 50 °C. The cardboard box prevented the chamber circulation fan from blowing air across the plastic enclosure. A thermocouple, attached to pin 2 of U1, was used to monitor its temperature.

Item	Temperature (°C)	
	85 VAC	265 VAC
Ambient	50	50
LinkSwitch (U1)	78	84

This result indicates acceptable thermal margin of approximately of 16 °C to the recommended maximum SOURCE pin temperature of 100 °C

10.2 Thermal Image

An infrared thermograph of the board was taken to measure the temperature of other components. This identified U1 and D4 as the highest temperature components. Using the results from the previous section, this indicates that D4 would also have an acceptable temperature rise at 50 °C ambient.

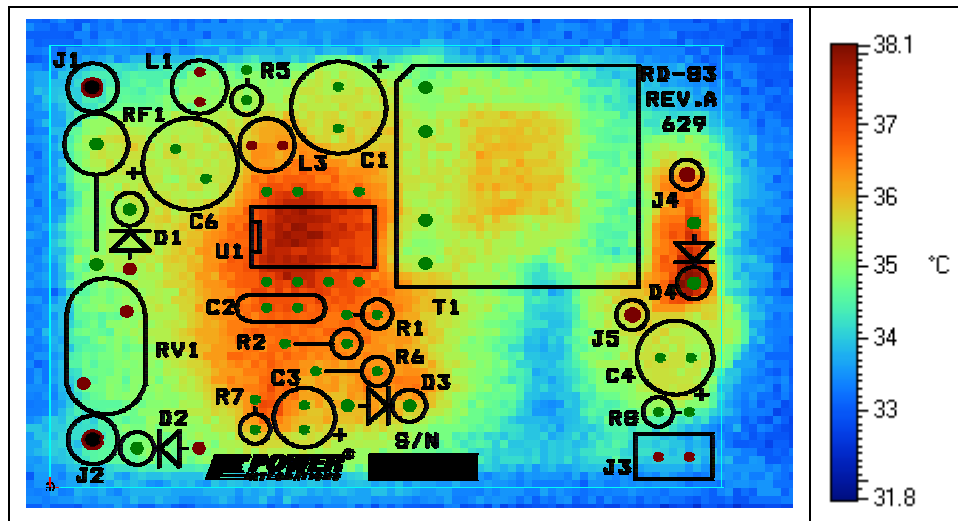

Figure 11 – Thermal Image of the RD-83 at Full Load, 85 VAC Input and Ambient Temperature of 22 °C.



11 Waveforms

11.1 Drain Voltage and Current, Normal Operation

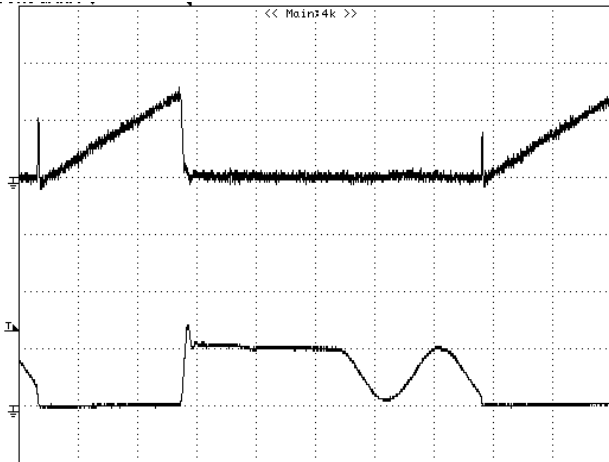

Figure 12 – 85 VAC, Full Load .
 Upper: I_{DRAIN} , 0.1 A / div.
 Lower: V_{DRAIN} , 200 V/Div, 2 μ s / div.

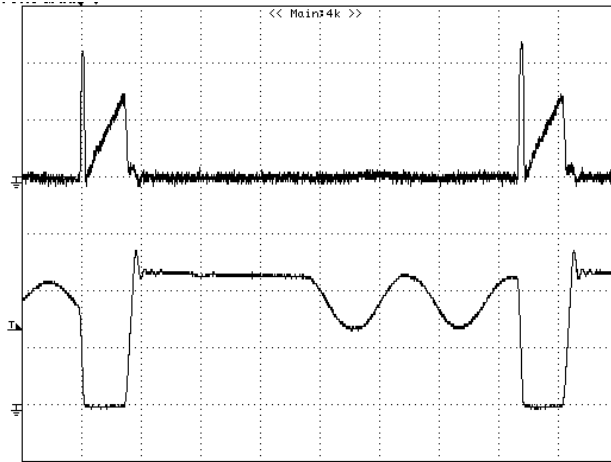

Figure 13 – 265 VAC, Full Load.
 Upper: I_{DRAIN} , 0.1 A / div.
 Lower: V_{DRAIN} , 200 V/Div, 2 μ s / div.

11.2 Output Voltage Start-up Profile

The output was loaded with a 39 Ω resistive load.

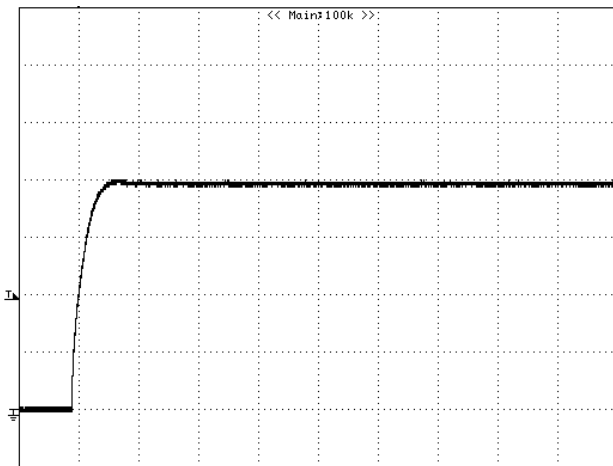

Figure 14 – Start-up Profile, 115VAC.
 2 V, 20 ms / div.

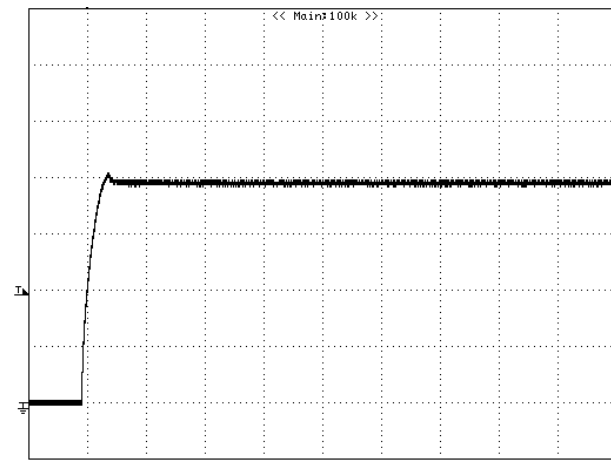

Figure 15 – Start-up Profile, 230 VAC.
 2 V, 20 ms / div.

The start-up waveforms show minimal output overshoot (<200 mV).



11.3 Drain Voltage and Current Start-up Profile

The output was loaded with a 39 Ω resistive load and the output profile captured. These waveforms show no sign of core saturation and acceptable margin to the recommended maximum drain voltage of 650 V_{PK}.

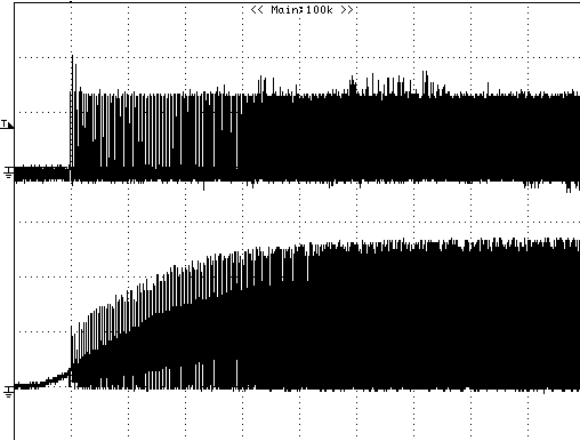

Figure 16 – 85 VAC Input and Maximum Load.
Upper: I_{DRAIN}, 0.1 A / div.
Lower: V_{DRAIN}, 100 V & 1 ms / div.

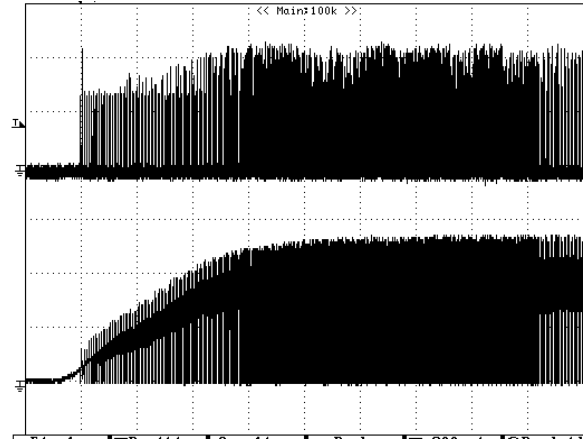

Figure 17 – 265 VAC Input and Maximum Load.
Upper: I_{DRAIN}, 0.1 A / div.
Lower: V_{DRAIN}, 200 V & 1 ms / div.



11.4 Load Transient Response (50% to 100% Load Step)

In the figures shown below, signal averaging was used to better enable viewing the load transient response. The oscilloscope was triggered using the load current step as a trigger source. Since the output switching and line frequency occur essentially at random with respect to the load transient, contributions to the output ripple from these sources will average out, leaving the contribution only from the load step response.

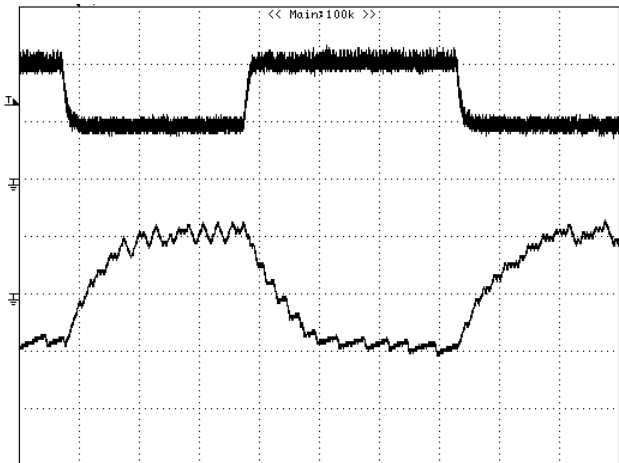

Figure 18 – Transient Response, 115 VAC, 50-100-50% Load Step.
Top: Load Current, 0.1 A/div.
Bottom: Output Voltage
200 mV, 500 μ s / div.

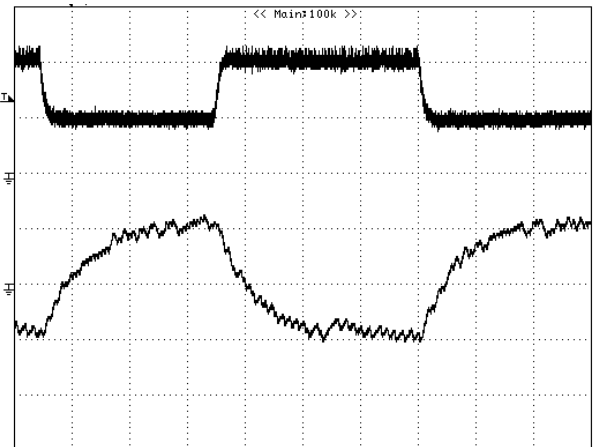

Figure 19 – Transient Response, 230 VAC, 50-100-50% Load Step.
Upper: Load Current, 0.1 A/ div.
Bottom: Output Voltage
200 mV, 500 μ s / div.

These results were significantly lower than the linear adapter where ripple and transient response variation was greater than 1 V_{P-P}.



11.5 Output Ripple Measurements

11.5.1 Ripple Measurement Technique

For DC output ripple measurements, a modified oscilloscope test probe must be utilized in order to reduce the pickup of spurious signals. Details of the probe modification are provided in Figure 20 and Figure 21.

The 5125BA probe adapter (from probe master) is affixed with two capacitors tied in parallel across the probe tip. The capacitors include one (1) 0.1 $\mu\text{F}/50\text{ V}$ ceramic type and one (1) 1.0 $\mu\text{F}/50\text{ V}$ aluminum electrolytic. The aluminum electrolytic type capacitor is polarized, so proper polarity across DC outputs must be maintained (see Figure 21).

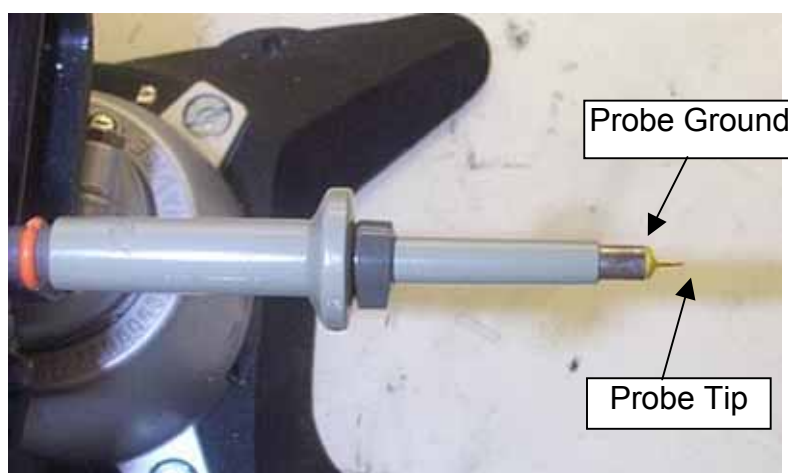

Figure 20 – Oscilloscope Probe Prepared for Ripple Measurement (End Cap and Ground Lead Removed).



Figure 21 – Oscilloscope Probe with Probe Master 5125BA BNC Adapter (Modified with wires for probe ground for ripple measurement, and two parallel decoupling capacitors added).

11.5.2 Measurement Results

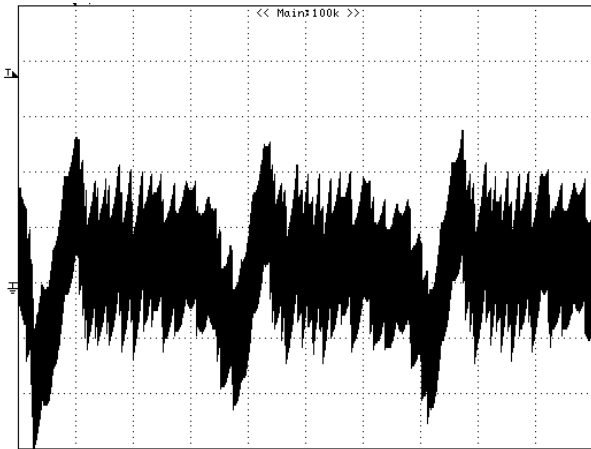

Figure 22 – Ripple, 85 VAC, Full Load.
5 ms, 50 mV / div (240 mV_{P-P}).

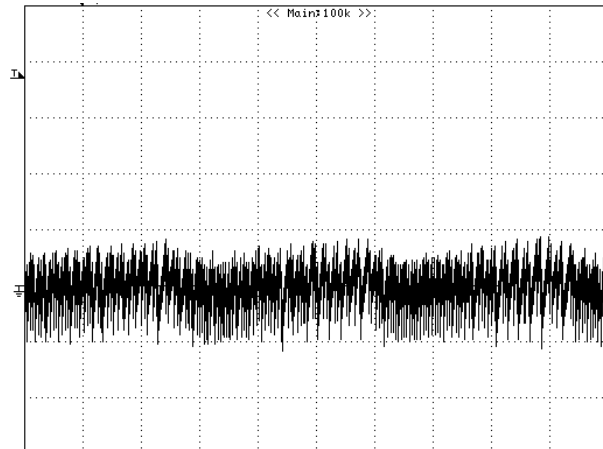

Figure 23 – Ripple, 115 VAC, Full Load.
5 ms, 50 mV / div (80 mV_{P-P}).

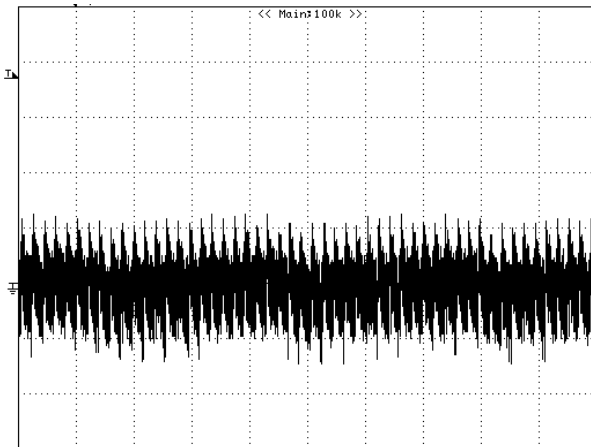

Figure 24 – Ripple, 230 VAC, Full Load.
5 ms, 50 mV /div (130mV_{P-P}).

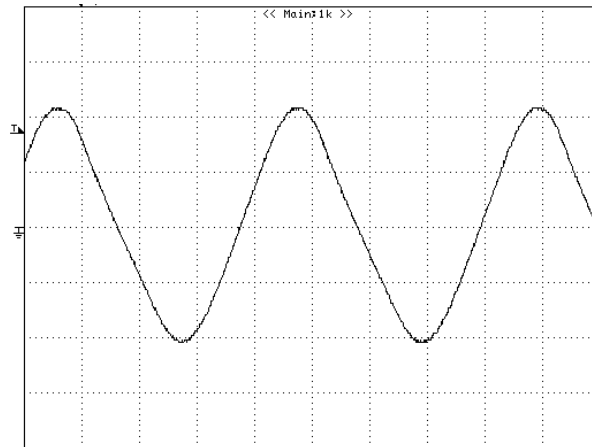

Figure 25 – Ripple of a Linear adaptor, 115 VAC
Input, Full Load.
2 ms, 200 mV/div (800 mV_{P-P}).

Figure 22 shows increased line frequency ripple. If required, this could be lowered to the level shown in Figure 23 by increasing the value of C6 and C1 to 4.7 μ F.



12 Line Surge

Differential and common mode 1.2/50 μ s surge testing was completed on a single test unit, to IEC61000-4-5. Input voltage was set at 230 VAC / 60 Hz. The output of the supply was loaded to full load, and correct operation was verified following each surge event.

Surge Level (V)	Input Voltage (VAC)	Injection Location	Injection Phase (°)	Test Result (Pass/Fail)
+2000	230	L to N	90	Pass
-2000	230	L to N	90	Pass
+10000	230	L,N to RTN	90	Pass
-10000	230	L,N to RTN	90	Pass

Unit passed under all test conditions.



13 Conducted EMI

Measurements were made with the output RTN of the supply connected to the artificial hand connection on the LISN (line impedance stabilization network) to represent worst-case conditions.

The results show excellent margin of >15 dB μ V to both the quasi-peak and the average limit lines.



Figure 26 – Conducted EMI, Maximum Steady State Load, 115 VAC, 60 Hz, and EN55022 B Limits.



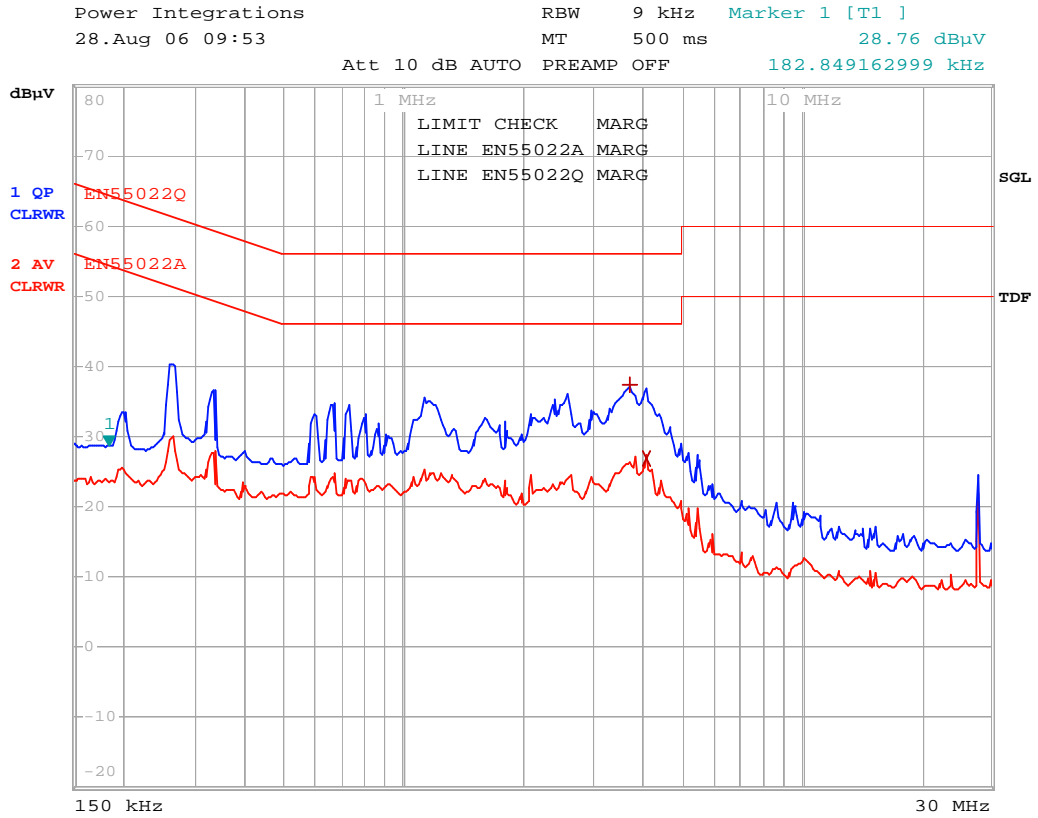

Figure 27 – Conducted EMI, Maximum Steady State Load, 230 VAC, 60 Hz, and EN55022 B Limits.



14 Revision History

Date	Author	Revision	Description & changes	Reviewed
29-Sept-06	JAC	1.0	Initial Release	PV, JJ, DA



Notes



Notes



Notes



For the latest updates, visit our website: www.powerint.com

Power Integrations reserves the right to make changes to its products at any time to improve reliability or manufacturability. Power Integrations does not assume any liability arising from the use of any device or circuit described herein. POWER INTEGRATIONS MAKES NO WARRANTY HEREIN AND SPECIFICALLY DISCLAIMS ALL WARRANTIES INCLUDING, WITHOUT LIMITATION, THE IMPLIED WARRANTIES OF MERCHANTABILITY, FITNESS FOR A PARTICULAR PURPOSE, AND NON-INFRINGEMENT OF THIRD PARTY RIGHTS.

PATENT INFORMATION

The products and applications illustrated herein (including transformer construction and circuits external to the products) may be covered by one or more U.S. and foreign patents, or potentially by pending U.S. and foreign patent applications assigned to Power Integrations. A complete list of Power Integrations' patents may be found at www.powerint.com. Power Integrations grants its customers a license under certain patent rights as set forth at <http://www.powerint.com/ip.htm>.

The PI Logo, *TOPSwitch*, *TinySwitch*, *LinkSwitch*, *DPA-Switch*, *PeakSwitch*, *EcoSmart*, *Clampless*, *E-Shield*, *Filterfuse*, *PI Expert* and *PI FACTS* are trademarks of Power Integrations, Inc. Other trademarks are property of their respective companies. ©Copyright 2006 Power Integrations, Inc.

Power Integrations Worldwide Sales Support Locations

WORLD HEADQUARTERS

5245 Hellyer Avenue
San Jose, CA 95138, USA.
Main: +1-408-414-9200
Customer Service:
Phone: +1-408-414-9665
Fax: +1-408-414-9765
e-mail: usasales@powerint.com

CHINA (SHANGHAI)

Rm 807-808A,
Pacheer Commercial Centre,
555 Nanjing Rd. West
Shanghai, P.R.C. 200041
Phone: +86-21-6215-5548
Fax: +86-21-6215-2468
e-mail: chinasales@powerint.com

CHINA (SHENZHEN)

Room 2206-2207, Block A,
Elec. Sci. Tech. Bldg.
2070 Shennan Zhong Rd.
Shenzhen, Guangdong,
China, 518031
Phone: +86-755-8379-3243
Fax: +86-755-8379-5828
e-mail: chinasales@powerint.com

GERMANY

Rueckertstrasse 3
D-80336, Munich
Germany
Phone: +49-89-5527-3910
Fax: +49-89-5527-3920
e-mail: eurosales@powerint.com

INDIA

261/A, Ground Floor
7th Main, 17th Cross,
Sadashivanagar
Bangalore, India 560080
Phone: +91-80-41138020
Fax: +91-80-41138023
e-mail: indiasales@powerint.com

ITALY

Via De Amicis 2
20091 Bresso MI – Italy
Phone: +39-028-928-6000
Fax: +39-028-928-6009
e-mail: eurosales@powerint.com

JAPAN

Keihin Tatemono 1st Bldg
2-12-20
Shin-Yokohama, Kohoku-ku,
Yokohama-shi, Kanagawa ken,
Japan 222-0033
Phone: +81-45-471-1021
Fax: +81-45-471-3717
e-mail: japansales@powerint.com

KOREA

RM 602, 6FL
Korea City Air Terminal B/D,
159-6
Samsung-Dong, Kangnam-Gu,
Seoul, 135-728, Korea
Phone: +82-2-2016-6610
Fax: +82-2-2016-6630
e-mail: koreasales@powerint.com

SINGAPORE

51 Newton Road,
#15-08/10 Goldhill Plaza,
Singapore, 308900
Phone: +65-6358-2160
Fax: +65-6358-2015
e-mail: singaporesales@powerint.com

TAIWAN

5F, No. 318, Nei Hu Rd., Sec. 1
Nei Hu Dist.
Taipei, Taiwan 114, R.O.C.
Phone: +886-2-2659-4570
Fax: +886-2-2659-4550
e-mail: taiwansales@powerint.com

UNITED KINGDOM

1st Floor, St. James's House
East Street, Farnham
Surrey, GU9 7TJ
United Kingdom
Phone: +44 (0) 1252-730-140
Fax: +44 (0) 1252-727-689
e-mail: eurosales@powerint.com

APPLICATIONS HOTLINE

World Wide +1-408-414-9660

APPLICATIONS FAX

World Wide +1-408-414-9760



Power Integrations

Tel: +1 408 414 9200 Fax: +1 408 414 9201
www.powerint.com